



Lexmark™

MS910 Series

User's Guide

March 2024

www.lexmark.com

Machine type(s):

4021

Model(s):

230

Contents

- Safety information..... 6**
 - Conventions..... 6
 - Product statements..... 6

- Learning about the printer..... 9**
 - Finding information about the printer.....9
 - Connecting the printer to an outlet..... 10
 - Selecting a location for the printer..... 10
 - Printer configurations..... 11

- Understanding the printer control panel..... 14**
 - Using the control panel.....14
 - Understanding the colors of the Sleep button and indicator lights..... 14
 - Understanding the home screen..... 15
 - Using the touch-screen buttons..... 16

- Setting up and using the home screen applications..... 18**
 - Finding the IP address of the printer.....18
 - Finding the IP address of the computer..... 18
 - Accessing the Embedded Web Server.....18
 - Activating the home screen applications.....19
 - Showing or hiding icons on the home screen..... 19
 - Using Background and Idle Screen..... 19
 - Setting up Forms and Favorites 19
 - Understanding Eco-Settings 20
 - Setting up Remote Operator Panel..... 21
 - Exporting and importing a configuration.....21

- Additional printer setup.....22**
 - Installing internal options..... 22
 - Installing hardware options.....34
 - Attaching cables..... 40
 - Setting up the printer software..... 41
 - Networking..... 41
 - Verifying printer setup.....46

Loading paper and specialty media.....	47
Setting the paper size and type.....	47
Configuring Universal paper settings.....	47
Loading trays.....	47
Loading the multipurpose feeder.....	49
Linking and unlinking trays.....	52
Paper and specialty media guide.....	54
Using specialty media.....	54
Paper guidelines.....	56
Supported paper sizes, types, and weights.....	59
Printing.....	65
Printing forms and a document.....	65
Printing from a flash drive or mobile device.....	65
Printing confidential and other held jobs.....	67
Printing information pages.....	69
Canceling a print job.....	69
Understanding the printer menus.....	71
Menus list.....	71
Paper menu.....	72
Reports menu.....	81
Network/Ports menu.....	82
Security menu.....	95
Settings menu.....	100
Help menu.....	122
Saving money and the environment.....	124
Saving paper and toner.....	124
Saving energy.....	125
Recycling.....	126
Securing the printer.....	128
Using the security lock feature.....	128
Statement of Volatility.....	128
Erasing volatile memory.....	129

Erasing non-volatile memory..... 129

Erasing printer hard disk memory..... 129

Configuring printer hard disk encryption..... 130

Finding the printer security information..... 130

Maintaining the printer..... 131

Updating firmware..... 131

Cleaning printer parts..... 133

Checking the status of parts and supplies..... 137

Estimated number of remaining pages..... 137

Ordering supplies..... 138

Ordering a 300K maintenance kit..... 139

Storing parts and supplies..... 139

Replacing supplies..... 140

Replacing the 300K maintenance kit..... 151

Moving the printer..... 161

Managing the printer..... 162

Checking the virtual display..... 162

Viewing reports..... 162

Copying printer settings to other printers..... 162

Configuring supply notifications from the Embedded Web Server..... 163

Restoring factory default settings..... 163

Clearing jams..... 164

Avoiding jams..... 164

Understanding jam messages and locations..... 165

[x]-page jam, clear jammed paper from multipurpose feeder. [200.xx]..... 166

[x]-page jam, open door C and clear all jammed paper. [2yy.xx]..... 167

[x]-page jam, slide the 3000-sheet tray and open door C. [2yy.xx]..... 169

[x]-page jam, open door D and clear all jammed paper. [24y.xx]..... 171

[x]-page jam, slide the 3000-sheet tray and open door D. [24y.xx]..... 172

[x]-page jam, slide the 3000-sheet tray and open door F. [24y.xx]..... 174

[x]-page jam, open doors G, H, and J and clear jammed paper. Leave paper in bin. [4yy.xx]..... 177

[x]-page jam, press latch to access area G. Leave paper in bin. [40y.xx]..... 180

[x]-page jam, press latch to access area G and clear jammed staples. Leave paper in bin. [402.93]..... 182

[x]-page jam, open door H and rotate knob H6 clockwise. Leave paper in bin. [426.xx–428.xx]..... 184

Troubleshooting..... 190

Understanding the printer messages.....190

Solving printer problems..... 203

Solving print problems.....211

Solving home screen application problems..... 238

Embedded Web Server does not open..... 238

Contacting customer support.....239

Notices.....241

Product information..... 241

Edition notice..... 241

Power consumption..... 246

Index..... 255

Safety information

Conventions

Note: A *note* identifies information that could help you.

Warning: A *warning* identifies something that could damage the product hardware or software.

WARNING (in full capitals): A *WARNING* indicates a risk of death or serious injury if not avoided.

CAUTION: A *caution* indicates a potentially hazardous situation that could injure you.

Different types of caution statements include:



CAUTION—POTENTIAL INJURY: Indicates a risk of injury.



CAUTION—SHOCK HAZARD: Indicates a risk of electrical shock.



CAUTION—HOT SURFACE: Indicates a risk of burn if touched.



CAUTION—TIPPING HAZARD: Indicates a crush hazard.



CAUTION—PINCH HAZARD: Indicates a risk of being caught between moving parts.

Product statements

Connect the power cord directly to an appropriately rated and properly grounded electrical outlet that is near the product and easily accessible.



CAUTION—POTENTIAL INJURY: Do not use this product with extension cords, multioutlet power strips, multioutlet extenders, or other types of surge or UPS devices. The power rating capacity of these types of accessories can be easily overloaded by a laser printer and may result in poor printer performance, property damage, or potential fire.

Do not place or use this product near water or wet locations.



CAUTION—POTENTIAL INJURY: This product uses a laser. Use of controls or adjustments or performance of procedures other than those specified herein may result in hazardous radiation exposure.

This product uses a printing process that heats the print media, and the heat may cause the media to release emissions. You must understand the section in your operating instructions that discusses the guidelines for selecting print media to avoid the possibility of harmful emissions.



CAUTION—POTENTIAL INJURY: The lithium battery in this product is not intended to be replaced. There is a danger of explosion if a lithium battery is incorrectly replaced. Do not recharge, disassemble, or incinerate a lithium battery. Discard used lithium batteries according to the manufacturer's instructions and local regulations.



WARNING

- **INGESTION HAZARD:** This product contains a button cell or coin battery.
- **DEATH** or serious injury can occur if ingested.
- A swallowed button cell or coin battery can cause **Internal Chemical Burns** in as little as **2 hours**.
- **KEEP** new and used batteries **OUT OF REACH of CHILDREN**.
- **Seek immediate medical attention** if a battery is suspected to be swallowed or inserted inside any part of the body.











Remove and immediately recycle or dispose of used batteries according to local regulations and keep away from children. Do not dispose of batteries in household trash or incinerate. Even used batteries may cause severe injury or death. Call a local poison control center for treatment information.

Battery type: CR6821

Nominal battery voltage: 3V

Do not force discharge, recharge, disassemble, heat above 60°C (140°F), or incinerate. Doing so may result in injury due to venting, leakage, or explosion resulting in chemical burns.

-  **CAUTION—HOT SURFACE:** The inside of the printer might be hot. To reduce the risk of injury from a hot component, allow the surface to cool before touching it.
-  **CAUTION—POTENTIAL INJURY:** To reduce the risk of equipment instability, load each tray separately. Keep all other trays closed until needed.
-  **CAUTION—POTENTIAL INJURY:** The printer weight is greater than 18 kg (40 lb) and requires two or more trained personnel to lift it safely.
-  **CAUTION—POTENTIAL INJURY:** Before moving the printer, follow these guidelines to avoid personal injury or printer damage:
 - Turn off the printer, and then unplug the power cord from the electrical outlet.
 - Disconnect all cords and cables from the printer.
 - If the printer does not have a caster base but is configured with optional trays, then remove the trays.
 - Use the handholds located on both sides of the printer to lift it.
 - Make sure your fingers are not under the printer when you set it down.
 - Make sure there is adequate clearance around the printer.
 - Use only the power cord provided with this product or the manufacturer's authorized replacement.
-  **CAUTION—POTENTIAL INJURY:** To reduce risk of fire, use only the telecommunications (RJ-11) cord provided with this product or a UL Listed 26 AWG or larger replacement when connecting this product to the public switched telephone network.
-  **CAUTION—SHOCK HAZARD:** If you are accessing the controller board or installing optional hardware or memory devices sometime after setting up the printer, then turn the printer off, and unplug the power cord from the electrical outlet before continuing. If you have any other devices attached to the printer, then turn them off as well, and unplug any cables going into the printer.
-  **CAUTION—SHOCK HAZARD:** To avoid the risk of electrical shock when cleaning the exterior of the printer, unplug the power cord from the electrical outlet and disconnect all cables from the printer before proceeding.

 **CAUTION—SHOCK HAZARD:** Make sure that all external connections (such as Ethernet and telephone system connections) are properly installed in their marked plug-in ports.

This product is designed, tested, and approved to meet strict global safety standards with the use of specific manufacturer's components. The safety features of some parts may not always be obvious. The manufacturer is not responsible for the use of other replacement parts.

This product produces ozone during normal operation, and is equipped with a filter designed to limit ozone concentrations to levels well below the recommended exposure limits. To avoid high ozone concentration levels during extensive usage, install this product in a well-ventilated area and replace the ozone and exhaust filters as indicated in the product maintenance instructions.

 **CAUTION—POTENTIAL INJURY:** Do not cut, twist, bind, crush, or place heavy objects on the power cord. Do not subject the power cord to abrasion or stress. Do not pinch the power cord between objects such as furniture and walls. If any of these things happen, a risk of fire or electrical shock results. Inspect the power cord regularly for signs of such problems. Remove the power cord from the electrical outlet before inspecting it.

Refer service or repairs, other than those described in the user documentation, to a service representative.

 **CAUTION—SHOCK HAZARD:** Do not set up this product or make any electrical or cabling connections, such as a power cord, a fax feature or USB cable, during a lightning storm.

 **CAUTION—TIPPING HAZARD:** Floor-mounted configurations require additional furniture for stability. You must use either a printer stand or printer base if you are using multiple input options. If you purchased a printer with a similar configuration, then you may need additional furniture. For more information, see www.lexmark.com/multifunctionprinters.

SAVE THESE INSTRUCTIONS.

Learning about the printer

Finding information about the printer

What are you looking for?	Find it here
Initial setup instructions: <ul style="list-style-type: none"> • Connecting the printer • Installing the printer software 	Setup documentation—The setup documentation came with the printer and is also available at http://support.lexmark.com .
Additional setup and instructions for using the printer: <ul style="list-style-type: none"> • Selecting and storing paper and specialty media • Loading paper • Configuring printer settings • Viewing and printing documents and photos • Setting up and using the printer software • Configuring the printer on a network • Caring for and maintaining the printer • Troubleshooting and solving problems 	<i>User's Guide</i> and <i>Quick Reference Guide</i> —The guides are available at http://support.lexmark.com . Note: These guides are also available in other languages.
Information on setting up and configuring the accessibility features of your printer	<i>Lexmark Accessibility Guide</i> —This guide is available at http://support.lexmark.com .
Help using the printer software	Windows or Mac Help—Open a printer software program or application, and then click Help . Click  to view context-sensitive information. Notes: <ul style="list-style-type: none"> • Help is automatically installed with the printer software. • The printer software is located in the printer program folder or on the desktop, depending on your operating system.

What are you looking for?	Find it here
<p>The latest supplemental information, updates, and customer support:</p> <ul style="list-style-type: none"> • Documentation • Driver downloads • Live chat support • E-mail support • Voice support 	<p>Lexmark support Web site— http://support.lexmark.com</p> <p>Note: Select your country or region, and then select your product to view the appropriate support site.</p> <p>Support telephone numbers and hours of operation for your country or region can be found on the support Web site or on the printed warranty that came with your printer.</p> <p>Record the following information (located on the store receipt and at the back of the printer), and have it ready when you contact customer support so that they may serve you faster:</p> <ul style="list-style-type: none"> • Machine Type number • Serial number • Date purchased • Store where purchased
<p>Warranty information</p>	<p>Warranty information varies by country or region:</p> <ul style="list-style-type: none"> • In the U.S.—See the Statement of Limited Warranty included with this printer, or go to http://support.lexmark.com. • In other countries and regions—See the printed warranty that came with this printer.

Connecting the printer to an outlet

Connect the power cord to the printer and then to a properly grounded and easily accessible electrical outlet.

Note: The electrical outlet may look different depending on your country or region.

Selecting a location for the printer

 **CAUTION—POTENTIAL INJURY:** The printer weight is greater than 18 kg (40 lb) and requires two or more trained personnel to lift it safely.

When selecting a location for the printer, leave enough room to open trays, covers, and doors. If you plan to install any options, then leave enough room for them also. It is important to:

- Set up the printer near a properly grounded and easily accessible electrical outlet.
- Make sure that airflow in the room meets the latest revision of the ASHRAE 62 standard or the CEN Technical Committee 156 standard.
- Provide a flat, sturdy, and stable surface.
- Keep the printer:
 - Clean, dry, and free of dust.
 - Away from stray staples and paper clips.
 - Away from the direct airflow of air conditioners, heaters, or ventilators.
 - Free from direct sunlight and humidity extremes.

- Observe the recommended temperatures and avoid fluctuations:

Ambient temperature	10 to 30°C (50 to 86°F)
Storage temperature	-10 to 40°C (14 to 104°F)

- Allow the following recommended amount of space around the printer for proper ventilation:

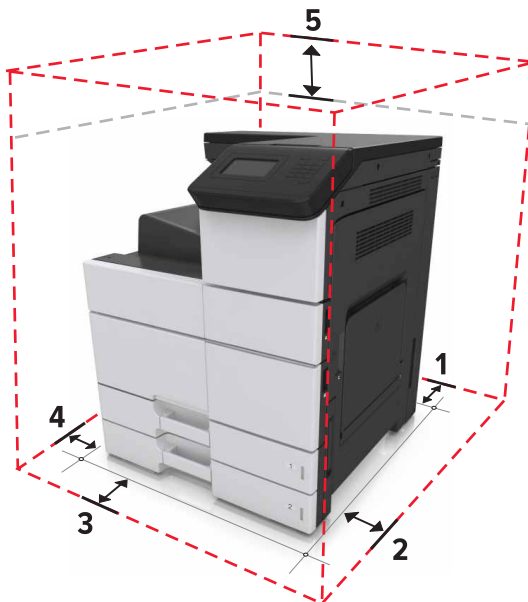

1	Rear	120 mm (4.8 in.)
2	Right side	400 mm (15.7 in.)
3	Front	444.5 mm (17.5 in.)
4	Left side	120 mm (4.8 in.)
5	Top	150 mm (5.9 in.)

Printer configurations

Note: Make sure to configure the printer on a flat, sturdy, and stable surface.

Basic model



1	Control panel
2	Multipurpose feeder
3	Standard 2 x 500-sheet tray
4	Standard bin

Configured model

CAUTION—TIPPING HAZARD: Floor-mounted configurations require additional furniture for stability. You must use either a printer stand or printer base if you are using multiple input options. If you purchased a printer with a similar configuration, then you may need additional furniture. For more information, see www.lexmark.com/multifunctionprinters.



	Hardware option	Alternative hardware option
1	Staple finisher	None
2	3000-sheet tray	None
3	2 x 500-sheet tray	2500-sheet tray
4	2500-sheet tray	2 x 500-sheet tray
5	Finisher <ul style="list-style-type: none">• Staple, hole punch finisher• Booklet finisher	None

When using optional trays:

- The 3000-sheet tray is supported only if the optional 2 x 500- or 2500-sheet tray is installed.
- The staple finisher is not supported if another finisher is installed.

Understanding the printer control panel

Using the control panel

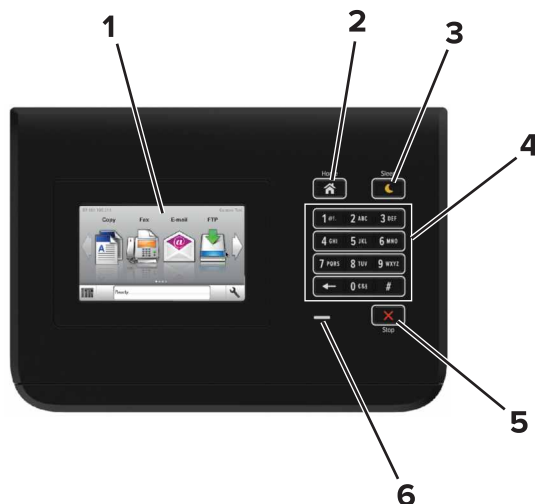

	Use the	To
1	Display	<ul style="list-style-type: none"> Show the status of the printer. Set up and operate the printer.
2	Home button	Go to the home screen.
3	Sleep button	Enable Sleep mode or Hibernate mode. The following actions wake the printer from Sleep mode: <ul style="list-style-type: none"> Touching the control panel home screen The following actions wake the printer from Hibernate mode: <ul style="list-style-type: none"> Pressing the Sleep button until the printer wakes Performing a power-on reset using the main power switch
4	Keypad	Enter numbers, letters, or symbols on the printer.
5	Stop or Cancel button	Stop all printer activity.
6	Indicator light	Check the status of the printer.

Understanding the colors of the Sleep button and indicator lights

The colors of the Sleep button and indicator lights on the printer control panel signify a certain printer status or condition.

Indicator light	Printer status
Off	The printer is off or in Hibernate mode.
Blinking green	The printer is warming up, processing data, or printing.
Solid green	The printer is on, but idle.
Blinking red	The printer requires user intervention.

Sleep button light	Printer status
Off	The printer is off, idle or in Ready state.
Solid amber	The printer is in Sleep mode.
Blinking amber	The printer is entering or waking from Hibernate mode.
Blinking amber for 0.1 second, then goes completely off for 1.9 seconds in a slow, pulsing pattern	The printer is in Hibernate mode.

Understanding the home screen

When the printer is turned on, the display shows a basic screen, referred to as the home screen. Use the home screen buttons and icons to initiate an action.

Note: Your home screen may vary depending on your home screen customization settings, administrative setup, and active embedded solutions.





Touch	To
1	Change Language Change the primary language of the printer.
2	Bookmarks Create, organize, and save a set of bookmarks (URLs) into a tree view of folders and file links. Note: The tree view does not include bookmarks created within Forms and Favorites, and the ones in the tree are not usable in Forms and Favorites.
3	Held Jobs Display all current held jobs.

Touch		To
4	USB	View, select, or print photos and documents from a flash drive. Note: This icon appears only when you return to the home screen while a memory card or flash drive is connected to the printer.
5	Menus	Access printer menus. Note: These menus are available only when the printer is in Ready state.
6	Status message bar	<ul style="list-style-type: none"> • Show the current printer status such as Ready or Busy. • Show the status of printer supplies. • Show intervention messages and the instructions on how to clear them.
7	Status/Supplies	<ul style="list-style-type: none"> • Show a printer warning or error message whenever the printer requires intervention to continue processing. • View more information on the printer warning or message, and on how to clear it.
8	Tips	View a context-sensitive help information.

These may also appear on the home screen:

Touch	To
Search Held Jobs	Search current held jobs.
Jobs by user	Access print jobs saved by user.
Profiles and Apps	Access profiles and applications.

Features



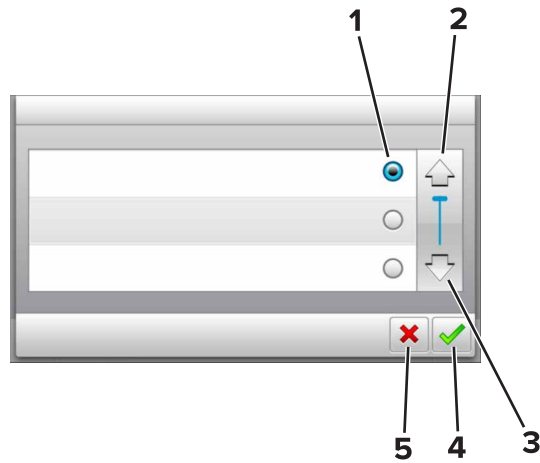

Feature	Description
Attendance message alert 	If an attendance message affects a function, then this icon appears and the red indicator light blinks.
Warning 	If an error condition occurs, then this icon appears.
Printer IP address Example: 123 . 123 . 123 . 123	The IP address of your printer is located at the top left corner of the home screen. You can use the IP address when accessing the Embedded Web Server to view and remotely configure printer settings.

Using the touch-screen buttons

Note: Your home screen may vary, depending on your home screen customization settings, administrative setup, and active embedded solutions.



	Touch the	To
1	Radio button	Select or clear an item.
2	Up arrow	Scroll up.
3	Down arrow	Scroll down.
4	Accept button	Save a setting.
5	Cancel button	<ul style="list-style-type: none"> • Cancel an action or a selection. • Return to the previous screen.

Touch	To
	Return to the home screen.
	Open a context-sensitive Help dialog on the printer control panel.
	Scroll to the left.
	Scroll to the right.

Setting up and using the home screen applications

Notes:

- Your home screen may vary depending on your home screen customization settings, administrative setup, and active embedded applications. Some applications are supported only in some printer models.
- There may be additional solutions and applications available for purchase. For more information, go to www.lexmark.com or contact the place where you purchased the printer.

Finding the IP address of the printer

Note: Make sure your printer is connected to a network or to a print server.

You can find the printer IP address:

- From the top left corner of the printer home screen.
- From the TCP/IP section in the Network/Ports menu.
- By printing a network setup page or menu settings page, and then finding the TCP/IP section.

Note: An IP address appears as four sets of numbers separated by periods, such as 123.123.123.123.

Finding the IP address of the computer

For Windows users

- 1 Run the command prompt.
- 2 Type **ipconfig**, and then look for the IP address.

For Macintosh users

- 1 From System Preferences in the Apple menu, select **Network**.
- 2 Select your connection type, and then click **Advanced** > **TCP/IP**.
- 3 Look for the IP address.

Accessing the Embedded Web Server

The Embedded Web Server is the printer Web page that lets you view and remotely configure printer settings even when you are not physically near the printer.

- 1 Obtain the printer IP address:
 - From the printer control panel home screen
 - From the TCP/IP section in the Network/Ports menu
 - By printing a network setup page or menu settings page, and then finding the TCP/IP section

Note: An IP address appears as four sets of numbers separated by periods, such as **123 . 123 . 123 . 123**.

- 2 Open a Web browser, and then type the printer IP address in the address field.
- 3 Press **Enter**.

Note: If you are using a proxy server, then temporarily disable it to load the Web page correctly.

Activating the home screen applications

Showing or hiding icons on the home screen

- 1 Open a Web browser, and then type the printer IP address in the address field.

Note: View the printer IP address on the printer control panel home screen. The IP address appears as four sets of numbers separated by periods, such as 123.123.123.123.

- 2 Click **Settings > General Settings > Home screen customization**.

A list of basic printer functions appears.

- 3 Select the check boxes to specify which icons appear on the printer home screen.

Note: Cleared check box items are hidden.

- 4 Click **Submit**.

Using Background and Idle Screen

Icon	Description
	The application lets you customize the background and idle screen of your printer home screen.

- 1 From the home screen, navigate to:
Change Background > select background to use
- 2 Touch .

Setting up Forms and Favorites

Note: A later version of this *User's Guide* may contain a direct link to the *Administrator's Guide* of this application. To check for updates of this *User's Guide*, go to <http://support.lexmark.com>.

Use	To
	<p>Streamline work processes by letting you quickly find and print frequently used online forms directly from the printer home screen.</p> <p>Note: The printer must have permission to access the network folder, FTP site, or Web site where the bookmark is stored. From the computer where the bookmark is stored, use sharing, security, and firewall settings to allow the printer at least a <i>read</i> access. For help, see the documentation that came with your operating system.</p>

1 Open a Web browser, and then type the printer IP address in the address field.

Note: View the printer IP address on the printer home screen. The IP address appears as four sets of numbers separated by periods, such as 123.123.123.123.

2 Click **Settings** > **Apps** > **Apps Management** > **Forms and Favorites**.

3 Click **Add**, and then customize the settings.

Notes:

- See the mouse-over help beside each field for a description of the setting.
- To make sure the location settings of the bookmark are correct, type the correct IP address of the host computer where the bookmark is located. For more information on obtaining the IP address of the host computer, see [“Finding the IP address of the computer” on page 18](#).
- Make sure the printer has access rights to the folder where the bookmark is located.

4 Click **Apply**.

To use the application, touch **Forms and Favorites** on the printer home screen, and then navigate through form categories, or search for forms based on a form number, name, or description.

Understanding Eco-Settings

Icon	Description
	<p>The application lets you easily manage energy consumption, noise, toner, and paper usage settings to help reduce the environmental impact of your printer.</p>

Setting up Remote Operator Panel

This application enables you to interact with the printer control panel even when you are not physically near the network printer. From your computer, you can view the printer status, release held print jobs, create bookmarks, and do other print-related tasks.

- 1 Open a Web browser, and then type the printer IP address in the address field.

Note: View the printer IP address on the printer home screen. The IP address appears as four sets of numbers separated by periods, such as 123.123.123.123.

- 2 Click **Settings > Remote Operator Panel Settings**.
- 3 Select the **Enable** check box, and then customize the settings.
- 4 Click **Submit**.

To use the application, click **Remote Operator Panel > Launch VNC Applet**.

Exporting and importing a configuration

You can export configuration settings into a text file, and then import the file to apply the settings to other printers.

- 1 Open a Web browser, and then type the printer IP address in the address field.

Note: View the IP address on the printer home screen. The IP address appears as four sets of numbers separated by periods, such as 123.123.123.123.

- 2 Export or import a configuration file for one or multiple applications.

For one application

- a Navigate to:
Settings > Apps > Apps Management > select an application > Configure
- b Export or import the configuration file.

Notes:

- If a **JVM Out of Memory** error occurs, then repeat the export process until the configuration file is saved.
- If a timeout occurs and a blank screen appears, then refresh the Web browser, and then click **Apply**.

For multiple applications

- a Click **Settings > Import/Export**.
- b Export or import a configuration file.

Note: When importing a configuration file, click **Submit** to complete the process.

Additional printer setup

Installing internal options

⚠ CAUTION—SHOCK HAZARD: If you are accessing the controller board or installing optional hardware or memory devices sometime after setting up the printer, then turn the printer off, and unplug the power cord from the electrical outlet before continuing. If you have any other devices attached to the printer, then turn them off as well, and unplug any cables going into the printer.

Available internal options

- Memory card
 - DDR2 DIMM
 - Flash memory
 - Fonts
 - Firmware cards
 - Forms and Bar Code
 - PRESCRIBE
 - IPDS
- Printer hard disk
- Lexmark™ Internal Solutions Ports (ISP)
 - Standard 10/100/1000 Ethernet
 - MarkNet™ N8350 802.11 b/g/n wireless print server
 - MarkNet N8352 802.11 b/g/n wireless print server

Accessing the controller board

Note: Use the screwdriver located inside the bottom front door of the printer.

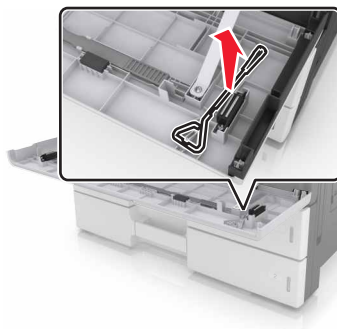

⚠ CAUTION—SHOCK HAZARD: If you are accessing the controller board or installing optional hardware or memory devices sometime after setting up the printer, then turn the printer off, and unplug the power cord from the electrical outlet before continuing. If you have any other devices attached to the printer, then turn them off as well, and unplug any cables going into the printer.

- 1 Remove the connector cover.

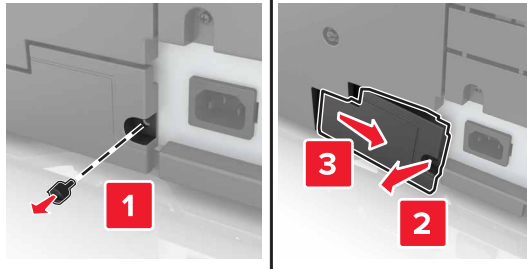

- 2 Remove the screws from the controller board access cover.

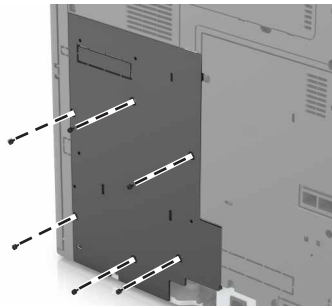

- 3 Remove the access cover.

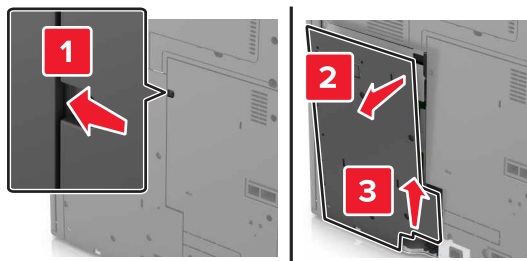

- 4 Use the following illustration to locate the appropriate connector:

Warning—Potential Damage: Controller board electronic components are easily damaged by static electricity. Touch a metal surface on the printer before touching any controller board electronic components or connectors.



1	Option card connector
2	Memory card connector
3	Lexmark Internal Solutions Port or printer hard disk connector

5 Align the base of the access cover to the printer.

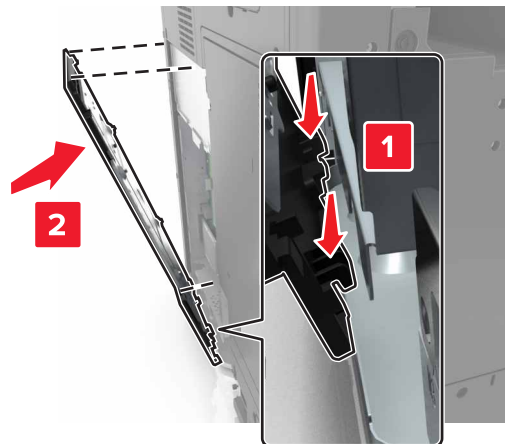

- 6 Reattach the access cover.

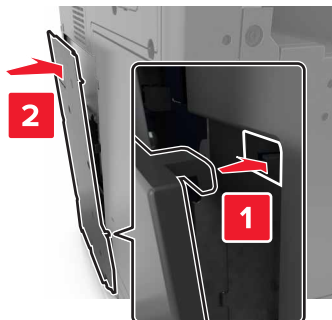

- 7 Tighten the screws on the access cover.
- 8 Reattach the connector cover.

Installing a memory card

CAUTION—SHOCK HAZARD: If you are accessing the controller board or installing optional hardware or memory devices sometime after setting up the printer, then turn the printer off, and unplug the power cord from the electrical outlet before continuing. If you have any other devices attached to the printer, then turn them off as well, and unplug any cables going into the printer.

- 1 Access the controller board.
For more information, see [“Accessing the controller board” on page 22.](#)

- 2 Unpack the memory card.

Warning—Potential Damage: Do not touch the connection points along the edge of the card. Doing so may cause damage.

- 3 Align the notch (1) on the memory card with the ridge (2) on the connector.

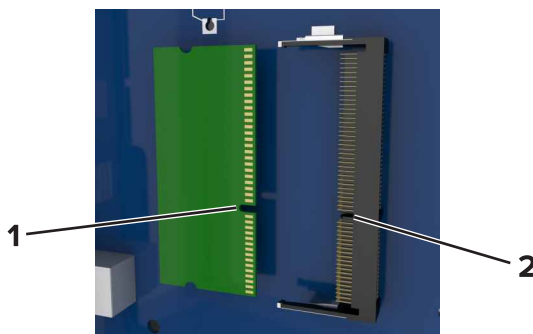

- 4 Push the memory card straight into the connector, and then push the card toward the controller board wall until it *clicks* into place.

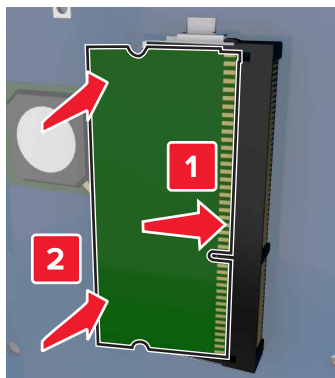

Installing an optional card

⚠ CAUTION—SHOCK HAZARD: If you are accessing the controller board or installing optional hardware or memory devices sometime after setting up the printer, then turn the printer off, and unplug the power cord from the electrical outlet before continuing. If you have any other devices attached to the printer, then turn them off as well, and unplug any cables going into the printer.

Warning—Potential Damage: Controller board electronic components are easily damaged by static electricity. Touch a metal surface on the printer before touching any controller board electronic components or connectors.

- 1 Access the controller board.

For more information, see [“Accessing the controller board” on page 22](#).

- 2 Unpack the optional card.

Warning—Potential Damage: Avoid touching the connection points along the edge of the card. Doing so may cause damage.

- 3 Holding the card by its sides, align the plastic pins (1) on the card with the holes (2) on the controller board.

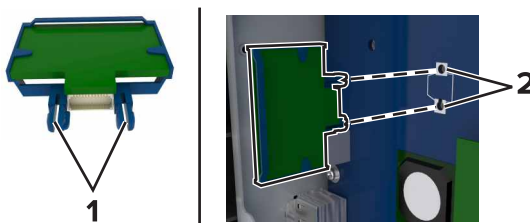

- 4 Push the card firmly into place.

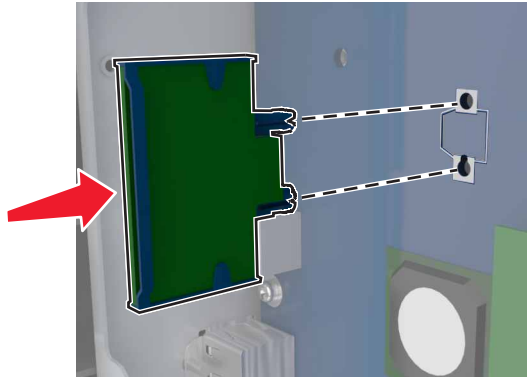

Warning—Potential Damage: Improper installation of the card may cause damage to the card and the controller board.

Note: The entire length of the connector on the card must touch and be flush with the controller board.

Installing an Internal Solutions Port

Note: Use the screwdriver located inside the bottom front door of the printer.

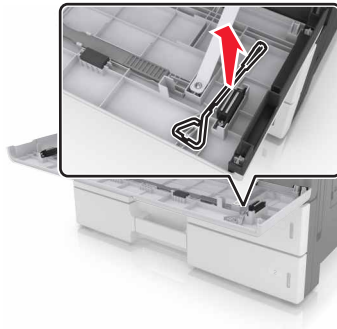

The controller board supports one optional Lexmark Internal Solutions Port (ISP). Install an ISP for additional connectivity options.

⚠ CAUTION—SHOCK HAZARD: If you are accessing the controller board or installing optional hardware or memory devices sometime after setting up the printer, then turn the printer off, and unplug the power cord from the electrical outlet before continuing. If you have any other devices attached to the printer, then turn them off as well, and unplug any cables going into the printer.

Warning—Potential Damage: Controller board electronic components are easily damaged by static electricity. Touch a metal surface on the printer first before touching any controller board electronic components or connectors.

1 Unpack the ISP kit.

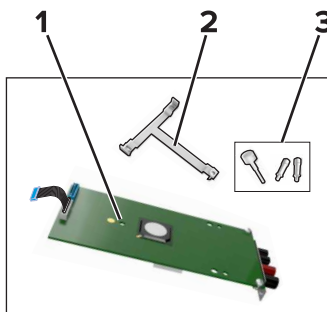

1	ISP
2	Plastic mounting bracket
3	Thumbscrews

2 Access the controller board. For more information, see [“Accessing the controller board” on page 22](#).

3 Align the posts of the plastic mounting bracket with the holes on the controller board cage, and then press the bracket on the cage until it *clicks* into place.

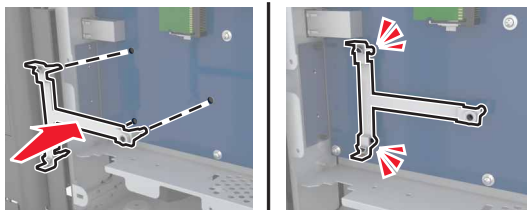

4 Install the ISP on the bracket.

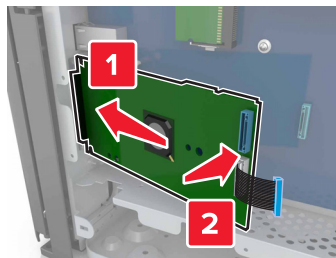

- 5 Use the thumbscrew to attach the bracket to the ISP.

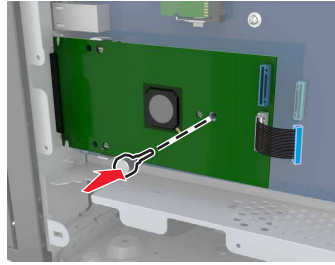

- 6 Secure the ISP mounting bracket to the controller board cage using the screws.

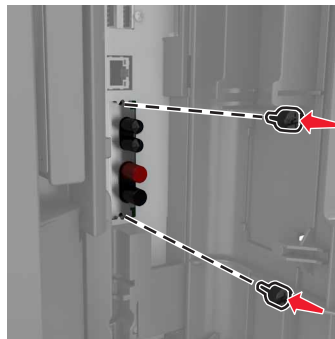

- 7 Insert the plug of the ISP interface cable into the connector of the controller board.

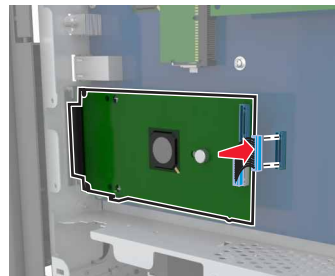

Installing a printer hard disk

Note: Use the screwdriver located inside the bottom front door of the printer.

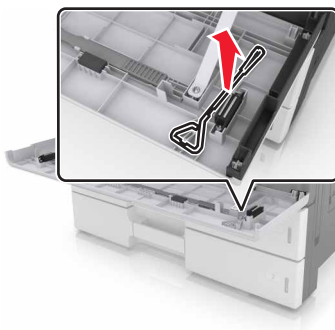

CAUTION—SHOCK HAZARD: If you are accessing the controller board or installing optional hardware or memory devices sometime after setting up the printer, then turn the printer off, and unplug the power cord from the electrical outlet before continuing. If you have any other devices attached to the printer, then turn them off as well, and unplug any cables going into the printer.

Warning—Potential Damage: Controller board electronic components are easily damaged by static electricity. Touch a metal surface on the printer before touching any controller board electronic components or connectors.

1 Access the controller board.

For more information, see [“Accessing the controller board” on page 22.](#)

2 Unpack the hard disk.

3 Locate the appropriate connector on the controller board cage.

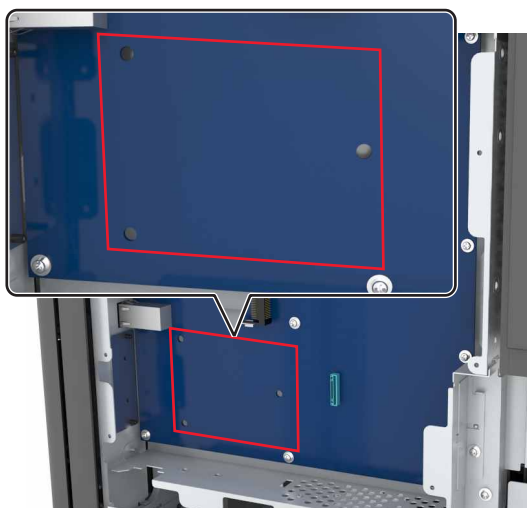

Note: If an optional ISP is installed, then the hard disk must be installed onto the ISP.

To install a hard disk onto the ISP:

- a** Remove the screws attached to the hard disk mounting bracket, and then remove the bracket.

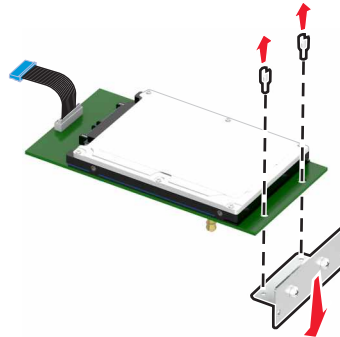

- b** Align the standoffs of the hard disk to the holes in the ISP, and then press the hard disk down until the standoffs are in place.

Installation warning: Hold the hard disk by its edges. Touching or pressing on the center of the hard disk may damage it.

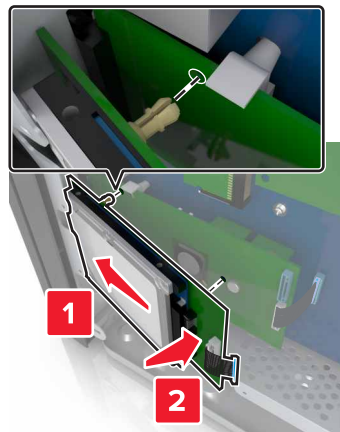

- c** Insert the plug of the hard disk interface cable into the receptacle of the ISP.

Note: The plugs and receptacles are color-coded.

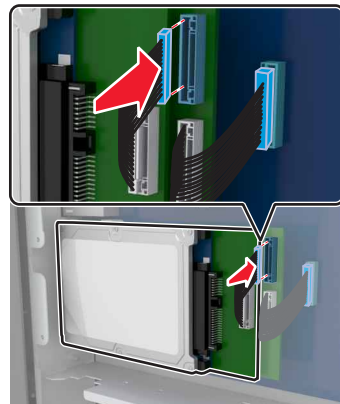

To install a hard disk directly on the controller board cage:

- a Align the standoffs of the hard disk to the holes in the controller board cage, and then press the hard disk down until the standoffs are in place.

Installation warning: Hold the hard disk by its edges. Touching or pressing on the center of the hard disk may damage it.

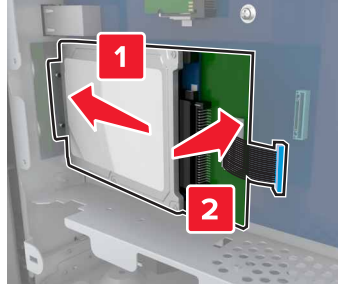

- b Use the two provided screws to attach the hard disk mounting bracket.

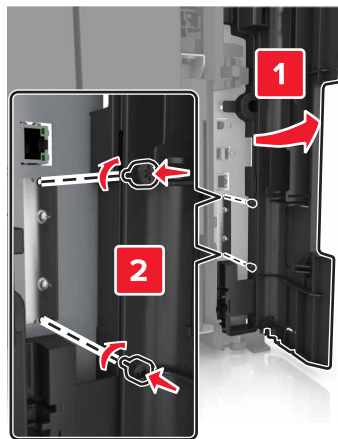

- c Insert the plug of the hard disk interface cable into the receptacle of the controller board.

Note: The plugs and receptacles are color-coded.

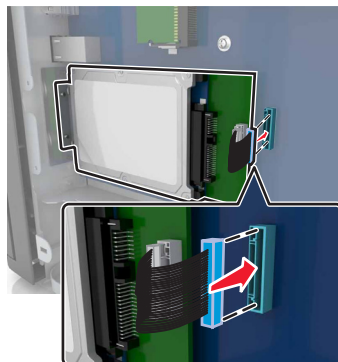

Removing a printer hard disk

Note: Use the screwdriver located inside the bottom front door of the printer.

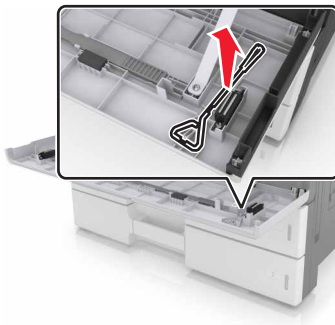

CAUTION—SHOCK HAZARD: If you are accessing the controller board or installing optional hardware or memory devices sometime after setting up the printer, then turn the printer off, and unplug the power cord from the electrical outlet before continuing. If you have any other devices attached to the printer, then turn them off as well, and unplug any cables going into the printer.

Warning—Potential Damage: Controller board electronic components are easily damaged by static electricity. Touch a metal surface on the printer before touching any controller board electronic components or connectors.

1 Access the controller board.

For more information, see [“Accessing the controller board” on page 22.](#)

2 Unplug the hard disk interface cable from the controller board, leaving the cable attached to the hard disk. To unplug the cable, squeeze the paddle at the plug of the interface cable to disengage the latch before pulling out the cable.

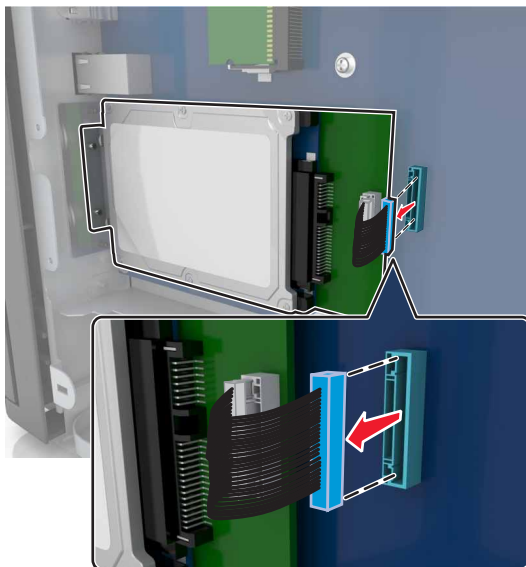

- 3 Remove the screws holding the hard disk in place.

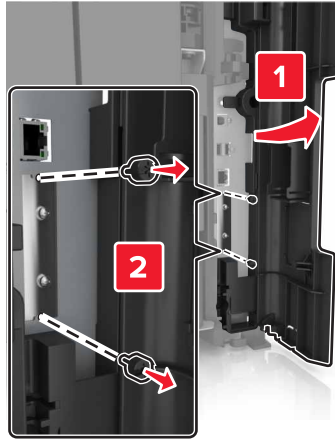

- 4 Remove the hard disk.

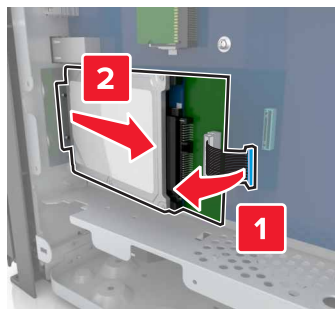

Installing hardware options

Order of installation

- CAUTION—POTENTIAL INJURY:** The printer weight is greater than 18 kg (40 lb) and requires two or more trained personnel to lift it safely.
- CAUTION—TIPPING HAZARD:** Floor-mounted configurations require additional furniture for stability. You must use either a printer stand or printer base if you are using multiple input options. If you purchased a printer with a similar configuration, then you may need additional furniture. For more information, see www.lexmark.com/multifunctionprinters.
- CAUTION—SHOCK HAZARD:** If you are accessing the controller board or installing optional hardware or memory devices sometime after setting up the printer, then turn the printer off, and unplug the power cord from the electrical outlet before continuing. If you have any other devices attached to the printer, then turn them off as well, and unplug any cables going into the printer.

Install the printer and any options you have purchased in the following order:

- Optional 2 x 500- or 2500-sheet tray
- Printer

- Staple finisher
- Staple, hole punch finisher or booklet finisher
- Optional 3000-sheet tray

Note: The staple finisher is not supported if another finisher is installed. For more information on installing the finishers and optional trays, see the instruction sheet that came with the option.

Installing optional trays

Notes:

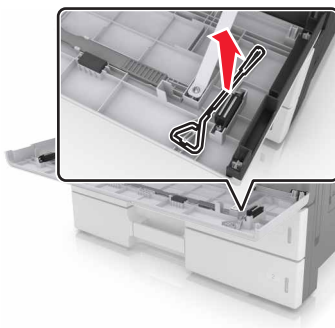

- For information on installing the optional 3000-sheet tray, see the instruction sheet that came with the option.
- Use the screwdriver located inside the bottom front door of the printer.



- CAUTION—POTENTIAL INJURY:** The printer weight is greater than 18 kg (40 lb) and requires two or more trained personnel to lift it safely.
- CAUTION—SHOCK HAZARD:** If you are accessing the controller board or installing optional hardware or memory devices sometime after setting up the printer, then turn the printer off, and unplug the power cord from the electrical outlet before continuing. If you have any other devices attached to the printer, then turn them off as well, and unplug any cables going into the printer.
- CAUTION—TIPPING HAZARD:** Floor-mounted configurations require additional furniture for stability. You must use either a printer stand or printer base if you are using multiple input options. If you purchased a printer with a similar configuration, then you may need additional furniture. For more information, see www.lexmark.com/multifunctionprinters.

The optional trays come with the following accessories:

Accessory name	Quantity
	2

Accessory name	Quantity
Locking clip 	3
Metal bracket 	1
Screw 	5

1 Turn off the printer.

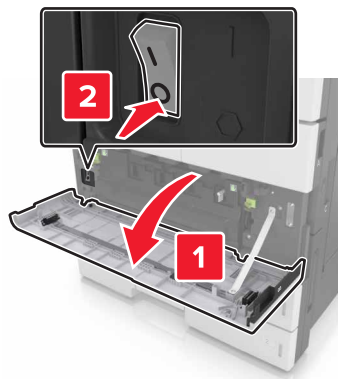

2 Unplug the power cord from the electrical outlet and from the printer.

3 Unpack the optional tray, and then remove all packing material.

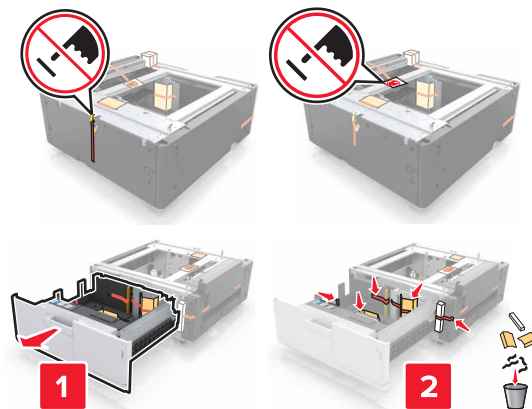

4 Attach the stabilizing feet to the optional tray.

Note: Make sure the feet *click* into place.

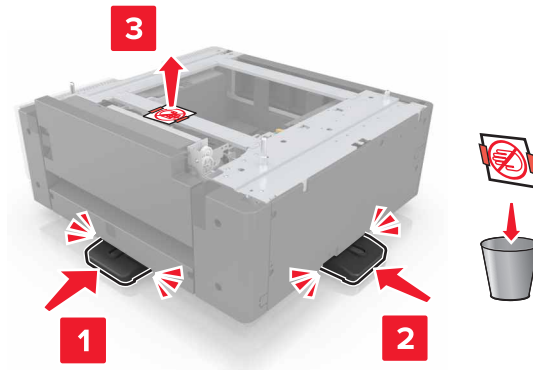

5 Remove the connector cover from the printer.

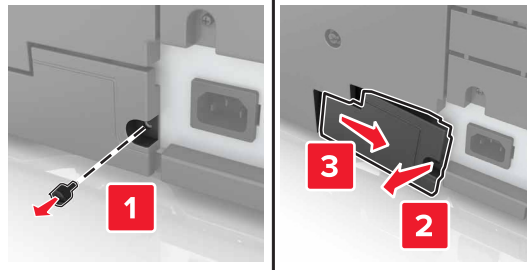

6 Lift the printer using the handles at the sides.

⚠ CAUTION—POTENTIAL INJURY: The printer weight is greater than 18 kg (40 lb) and requires two or more trained personnel to lift it safely.



7 Align the printer with the tray, and then lower the printer into place.



8 Remove the tape from the connectors, and then plug the connectors into the receptacle of the printer.

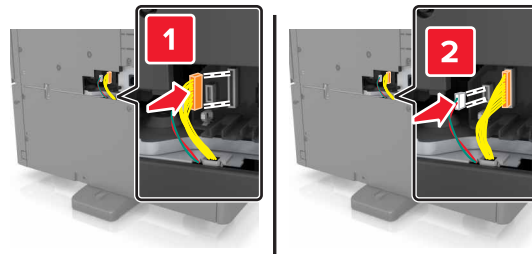

9 Open Tray 2 and Tray 3.

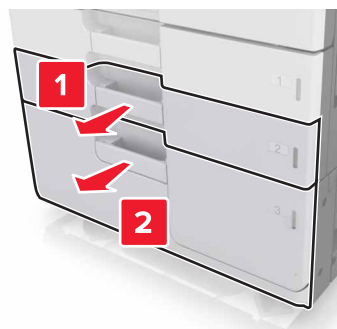

10 Secure the tray to the printer using the locking clips and the metal bracket.

- Back

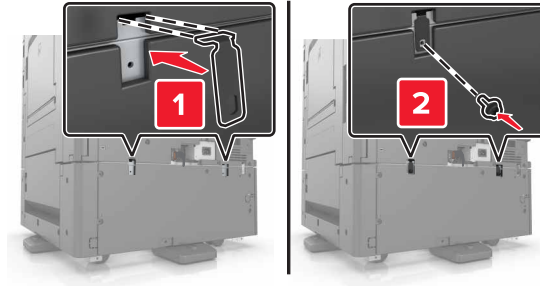

- Front

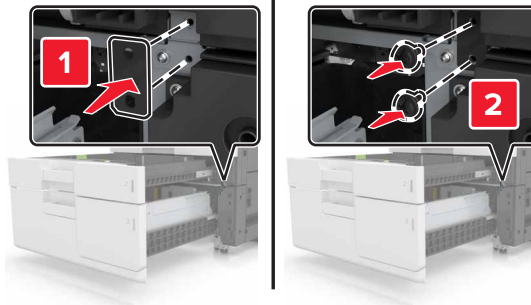
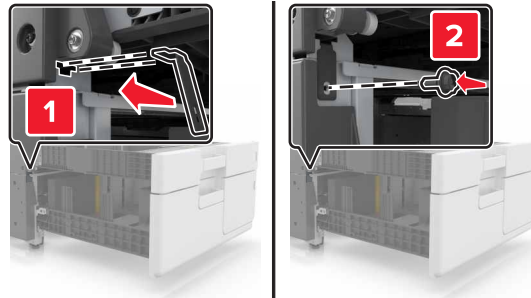

11 Reinstall the connector cover.

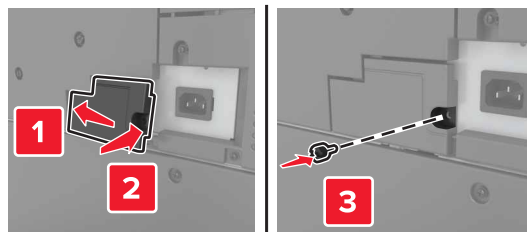

12 Connect the power cord to the printer and electrical outlet.

13 Turn on the printer.

14 Set the printer software to recognize the optional tray. For more information, see [“Adding available options in the print driver” on page 41](#).

Attaching cables

⚠ CAUTION—POTENTIAL INJURY: Do not set up this product or make any electrical or cabling connections, such as a power cord, a fax feature or USB cable, during a lightning storm.

Connect the printer to the computer using a USB cable, or to the network using an Ethernet cable.

Make sure to match the following:

- The USB symbol on the cable with the USB symbol on the printer
- The appropriate Ethernet cable to the Ethernet port

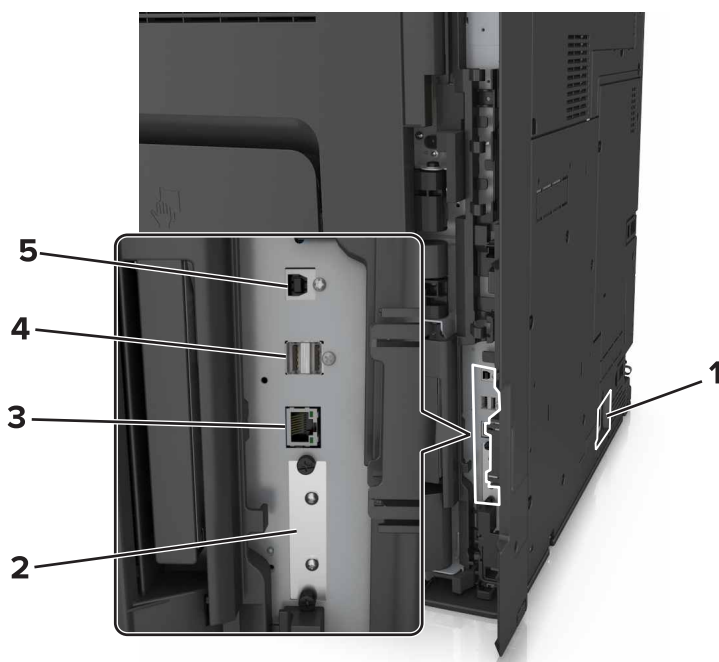

	Use the	To
1	Printer power cord socket	Connect the printer to a properly grounded electrical outlet.
2	Internal Solutions Port (ISP) or printer hard disk slot Note: If the printer has support for wireless connection, then the wireless antenna is attached here.	Attach an ISP or a printer hard disk.
3	Ethernet port	Connect the printer to a network.
4	USB ports	Attach a keyboard.
5	USB printer port	Connect the printer to a computer.

Warning—Potential Damage: Do not touch the USB cable, any wireless network adapter, or the printer in the area shown while actively printing. Loss of data or a malfunction can occur.

Setting up the printer software

Installing the printer

- 1 Obtain a copy of the software installer package.
- 2 Run the installer, and then follow the instructions on the computer screen.
- 3 For Macintosh users, add the printer.

Note: Obtain the printer IP address from the TCP/IP section in the Network/Ports menu.

Adding available options in the print driver

For Windows users

- 1 Open the printers folder.
- 2 Select the printer you want to update, and then do the following:
 - For Windows 7 or later, select **Printer properties**.
 - For earlier versions, select **Properties**.
- 3 Navigate to the Configuration tab, and then select **Update Now - Ask Printer**.
- 4 Apply the changes.

For Macintosh users

- 1 From System Preferences in the Apple menu, navigate to your printer, and then select **Options & Supplies**.
- 2 Navigate to the list of hardware options, and then add any installed options.
- 3 Apply the changes.

Networking

Notes:

- Purchase a MarkNet N8350 wireless network adapter before setting up the printer on a wireless network. For information on installing the wireless network adapter, see the instruction sheet that came with the adapter.
- A Service Set Identifier (SSID) is a name assigned to a wireless network. Wired Equivalent Privacy (WEP), Wi-Fi Protected Access (WPA), WPA2, and 802.1X-RADIUS are types of security used on a network.

Preparing to set up the printer on an Ethernet network

To configure your printer to connect to an Ethernet network, organize the following information before you begin:

Note: If your network automatically assigns IP addresses to computers and printers, continue on to installing the printer.

- A valid, unique IP address for the printer to use on the network
- The network gateway
- The network mask
- A nickname for the printer (optional)

Note: A printer nickname can make it easier for you to identify your printer on the network. You can choose to use the default printer nickname, or assign a name that is easier for you to remember.

You will need an Ethernet cable to connect the printer to the network and an available port where the printer can physically connect to the network. Use a new network cable when possible to avoid potential problems caused by a damaged cable.

Preparing to set up the printer on a wireless network

Notes:

- Make sure your wireless network adapter is installed in your printer and working properly. For more information, see the instruction sheet that came with the wireless network adapter.
- Make sure your access point (wireless router) is turned on and is working properly.

Make sure you have the following information before setting up the printer on a wireless network:

- **SSID**—The SSID is also referred to as the network name.
- **Wireless Mode (or Network Mode)**—The mode is either infrastructure or ad hoc.
- **Channel (for ad hoc networks)**—The channel defaults to automatic for infrastructure networks.

Some ad hoc networks will also require the automatic setting. Check with your system support person if you are not sure which channel to select.

- **Security Method**—There are four basic options for Security Method:

- WEP key

If your network uses more than one WEP key, then enter up to four in the provided spaces. Select the key currently in use on the network by selecting the default WEP transmit key.

- WPA or WPA2 preshared key or passphrase

WPA includes encryption as an additional layer of security. The choices are AES or TKIP. Encryption must be set for the same type on the router and on the printer, or the printer will not be able to communicate on the network.

- 802.1X–RADIUS

If you are installing the printer on an 802.1X network, then you may need the following:

- Authentication type
- Inner authentication type
- 802.1X user name and password
- Certificates

- No security

If your wireless network does not use any type of security, then you will not have any security information.

Note: We do not recommend using an unsecured wireless network.

Notes:

- If you do not know the SSID of the network that your computer is connected to, then launch the wireless utility of the computer network adapter, and then look for the network name. If you cannot find the SSID or the security information for your network, then see the documentation that came with the access point, or contact your system support person.
- To find the WPA/WPA2 preshared key or passphrase for the wireless network, see the documentation that came with the access point, see the Embedded Web Server associated with the access point, or consult your system support person.

Connecting the printer using the Wireless Setup Wizard

Before you begin, make sure that:

- A wireless network adapter is installed in the printer and is working properly. For more information, see the instruction sheet that came with the wireless network adapter.
- An Ethernet cable is disconnected from the printer.
- Active NIC is set to Auto. To set this to Auto, navigate to:

 > **Network/Ports** > **Active NIC** > **Auto** > **Submit**

Note: Make sure to turn off the printer, then wait for at least five seconds, and then turn the printer back on.

1 From the printer control panel, navigate to:

 > **Network/Ports** > **Network [x]** > **Network [x] Setup** > **Wireless** > **Wireless Connection Setup**

2 Select a wireless connection setup.

Use	To
Search for networks	Show available wireless connections. Note: This menu item shows all broadcast secured or unsecured SSIDs.
Enter a network name	Manually type the SSID. Note: Make sure to type the correct SSID.
Wi-Fi Protected Setup	Connect the printer to a wireless network using Wi-Fi Protected Setup.

3 Follow the instructions on the printer display.

Connecting the printer to a wireless network using Wi-Fi Protected Setup

Before you begin, make sure that:

- The access point (wireless router) is Wi-Fi Protected Setup (WPS) certified or WPS-compatible. For more information, see the documentation that came with your access point.
- A wireless network adapter installed in your printer is attached and working properly. For more information, see the instruction sheet that came with the wireless network adapter.

Using the Push Button Configuration method

- 1 From the printer control panel, navigate to:



> **Network/Ports** > **Network [x]** > **Network [x] Setup** > **Wireless** > **Wireless Connection Setup** > **Wi-Fi Protected Setup** > **Start Push Button Method**

- 2 Follow the instructions on the printer display.

Using the Personal Identification Number (PIN) method

- 1 From the printer control panel, navigate to:



> **Network/Ports** > **Network [x]** > **Network [x] Setup** > **Wireless** > **Wireless Connection Setup** > **Wi-Fi Protected Setup** > **Start PIN Method**

- 2 Copy the eight-digit WPS PIN.
- 3 Open a Web browser, and then type the IP address of your access point in the address field.

Notes:

- The IP address appears as four sets of numbers separated by periods, such as 123.123.123.123.
- If you are using a proxy server, then temporarily disable it to load the Web page correctly.

- 4 Access the WPS settings. For more information, see the documentation that came with your access point.
- 5 Enter the eight-digit PIN, and then save the setting.

Connecting the printer to a wireless network using the Embedded Web Server

Before you begin, make sure that:

- Your printer is connected temporarily to an Ethernet network.
- A wireless network adapter is installed in your printer and working properly. For more information, see the instruction sheet that came with the wireless network adapter.

- 1 Open a Web browser, and then type the printer IP address in the address field.

Notes:

- View the printer IP address on the printer control panel. The IP address appears as four sets of numbers separated by periods, such as 123.123.123.123.
- If you are using a proxy server, then temporarily disable it to load the Web page correctly.

- 2 Click **Settings** > **Network/Ports** > **Wireless**.

- 3 Modify the settings to match the settings of your access point (wireless router).

Note: Make sure to enter the correct SSID, security method, preshared key or passphrase, network mode, and channel.

- 4 Click **Submit**.

- 5 Turn off the printer, and then disconnect the Ethernet cable. Then wait for at least five seconds, and then turn the printer back on.
- 6 To verify if your printer is connected to the network, print a network setup page. Then in the Network Card [x] section, see if the status is Connected.

Changing port settings after installing an internal solutions port

Notes:

- If the printer has a static IP address, then do not change the configuration.
- If the computers are configured to use the network name instead of an IP address, then do not change the configuration.
- If you are adding a wireless internal solutions port (ISP) to a printer previously configured for an Ethernet connection, then disconnect the printer from the Ethernet network.

For Windows users

- 1 Open the printers folder.
- 2 From the shortcut menu of the printer with the new ISP, open the printer properties.
- 3 Configure the port from the list.
- 4 Update the IP address.
- 5 Apply the changes.

For Macintosh users

- 1 From System Preferences in the Apple menu, navigate to the list of printers, and then select + > **IP**.
- 2 Type the IP address in the address field.
- 3 Apply the changes.

Setting up serial printing (Windows only)

- 1 Set the parameters in the printer.
 - a From the control panel, navigate to the menu for the port settings.
 - b Locate the menu for the serial port settings, and then adjust the settings, if necessary.
 - c Apply the changes.
- 2 From your computer, open the printers folder, and then select your printer.
- 3 Open the printer properties, and then select the COM port from the list.
- 4 Set the COM port parameters in Device Manager.

Notes:

- Serial printing reduces printing speed.
- Make sure that the serial cable is connected to the serial port on your printer.

Verifying printer setup

Printing a menu settings page

From the home screen, navigate to:

 > **Reports** > **Menu Settings Page**

Printing a network setup page

If the printer is attached to a network, then print a network setup page to verify the network connection. This page also provides important information that aids network printing configuration.

- 1 From the home screen, navigate to:

 > **Reports** > **Network Setup Page**

- 2 Check the first section of the network setup page, and confirm that the status is **Connected**.



If the status is **Not Connected**, then the LAN drop may not be active, or the network cable may be malfunctioning. Consult a system support person for a solution, and then print another network setup page.

Loading paper and specialty media

The selection and handling of paper and specialty media can affect how reliably documents print. For more information, see [“Avoiding jams” on page 164](#) and [“Storing paper” on page 59](#).

Setting the paper size and type

From the home screen navigate to:

 > **Paper Menu** > **Paper Size/Type** > select a tray > select the paper size or type > 

Configuring Universal paper settings

The Universal paper size setting is a user-defined setting that lets you print on paper sizes that are not preset in the printer menus.

1 From the home screen, navigate to:

 > **Paper Menu** > **Universal Setup**

2 Select a unit of measure, and then set the portrait width and height.

3 Apply the changes.

Loading trays

 **CAUTION—POTENTIAL INJURY:** To reduce the risk of equipment instability, load each tray separately. Keep all other trays closed until needed.

1 Pull out the tray.

Note: Do not remove trays while a job prints or while **Busy** appears on the printer display. Doing so may cause a jam.



2 Squeeze and slide the paper guides to the correct position for the size of the paper you are loading.

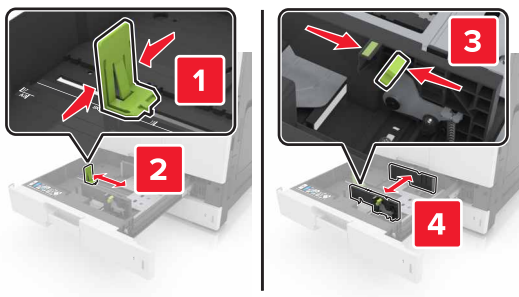

Note: Use the indicators on the bottom of the tray to position the guides.



3 Flex the sheets back and forth to loosen them, and then fan them. Do not fold or crease the paper. Straighten the edges on a level surface.

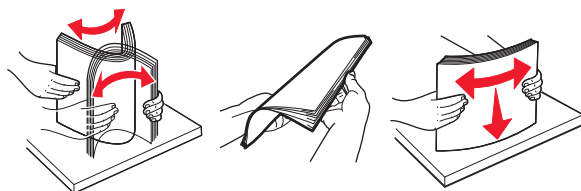

- 4 Load the paper stack with the printable side faceup.

**Notes:**

- Load printable side facedown for duplex printing.
- Load pre-punched paper with the holes toward the front or the left side of the tray.
- Load letterhead with the header on the left side of the tray.
- Make sure that the paper is below the maximum fill line on the edge of the paper tray. Overfilling may cause paper jams.

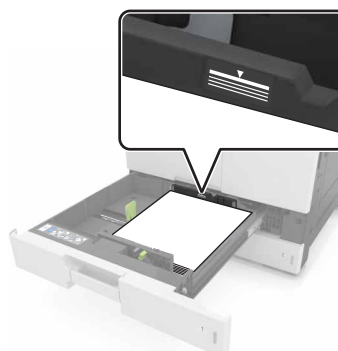

- 5 Insert the tray.
- 6 From the control panel, set the paper size and paper type in the Paper menu to match the paper loaded in the tray.

Loading the multipurpose feeder

- 1 Open the multipurpose feeder.

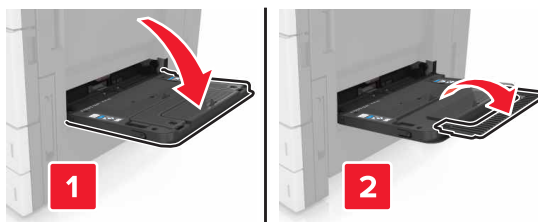

2 Adjust the guide to match the size of the paper you are loading.



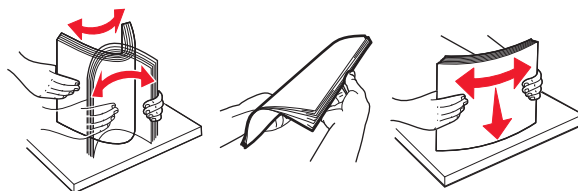

3 Flex the sheets of paper back and forth to loosen them, and then fan them. Do not fold or crease the paper. Straighten the edges on a level surface.





4 Load the paper.



- Load only one size and type of paper.

Loading letterhead

Without an optional finisher	With an optional finisher
<p data-bbox="233 1209 456 1241">One-sided printing</p>  <p data-bbox="233 1528 797 1619">Note: For long-edge orientation, load letterhead facedown with the header on the left side of the feeder.</p>	<p data-bbox="865 1209 1088 1241">One-sided printing</p>  <p data-bbox="865 1528 1429 1619">Note: For long-edge orientation, load letterhead facedown with the header on the right side of the feeder.</p>

Without an optional finisher	With an optional finisher
<p data-bbox="233 275 454 304">Two-sided printing</p>  <p data-bbox="233 594 799 684">Note: For long-edge orientation, load letterhead faceup with the header on the right side of the feeder.</p>	<p data-bbox="857 275 1078 304">Two-sided printing</p>  <p data-bbox="857 594 1422 684">Note: For long-edge orientation, load letterhead faceup with the header on the left side of the feeder.</p>

Loading prepunched paper

One-sided printing	Two-sided printing
	

- Load envelopes with the flap side up.

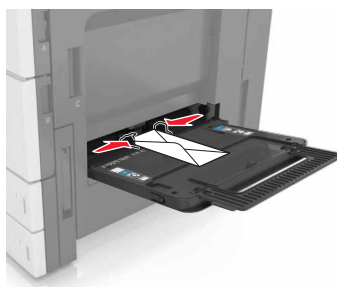

Warning—Potential Damage: Never use envelopes with stamps, clasps, snaps, windows, coated linings, or self-stick adhesives. These envelopes may severely damage the printer.

- Make sure that the paper is below the maximum fill line. Overfilling may cause paper jams.

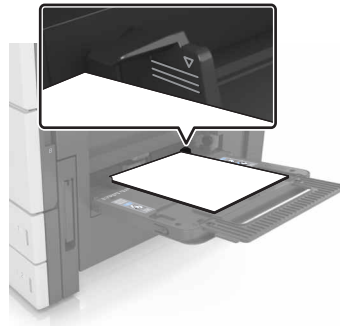

- 5 From the control panel, set the paper size and paper type in the Paper menu to match the paper loaded in the feeder.

Linking and unlinking trays

Linking and unlinking trays

- 1 Open a Web browser, and then type the printer IP address in the address field.

Notes:

- View the printer IP address on the printer home screen. The IP address appears as four sets of numbers separated by periods, such as 123.123.123.123.
- If you are using a proxy server, then temporarily disable it to load the Web page correctly.

- 2 Click **Settings > Paper Menu**.

- 3 Change the paper size and type settings for the trays you are linking.

- To link trays, make sure the paper size and type for the tray match that of the other tray.
- To unlink trays, make sure the paper size or type for the tray does *not* match that of the other tray.

- 4 Click **Submit**.

Note: You can also change the paper size and type settings using the printer control panel. For more information, see [“Setting the paper size and type” on page 47](#).

Warning—Potential Damage: Paper loaded in the tray should match the paper type name assigned in the printer. The temperature of the fuser varies according to the specified paper type. Printing issues may occur if settings are not properly configured.

Creating a custom name for a paper type

- 1 From the home screen, navigate to:

 > **Paper Menu > Custom Names**

- 2 Type a custom paper type name, and then apply the changes.

- 3 Touch **Custom Types**, and then verify if the new custom paper type name has replaced the custom name.

Assigning a custom paper type

Using the Embedded Web Server

Assign a custom paper type name to a tray when linking or unlinking trays.

- 1 Open a Web browser, and then type the printer IP address in the address field.

Notes:

- View the printer IP address on the printer home screen. The IP address appears as four sets of numbers separated by periods, such as 123.123.123.123.
- If you are using a proxy server, then temporarily disable it to load the Web page correctly.

- 2 Click **Settings** > **Paper Menu** > **Custom Types**.

- 3 Select a custom paper type name, and then select a paper type

Note: Paper is the factory default paper type for all user-defined custom names.

- 4 Click **Submit**.

Using the printer control panel

- 1 From the home screen, navigate to:



> **Paper Menu** > **Custom Types**

- 2 Select a custom paper type name, and then select a paper type

Note: Paper is the factory default paper type for all user-defined custom names.

- 3 Touch .

Paper and specialty media guide

Notes:

- Make sure that the paper size, type, and weight are set correctly on the computer or control panel.
- Flex, fan, and straighten specialty media before loading them.
- The printer may print at a reduced speed to prevent damage to the fuser.
- For more information on card stock and labels, see the *Card Stock & Label Guide* on the Lexmark support Web site at <http://support.lexmark.com>.

Using specialty media

Tips on using card stock

Card stock is heavy, single-ply specialty media. Many of its variable characteristics, such as moisture content, thickness, and texture, can significantly affect print quality.

- From the printer control panel, set the paper size, type, texture, and weight in the Paper menu to match the card stock loaded in the tray.
- Print samples on the card stock being considered for use before buying large quantities.
- Specify the paper texture and weight from the tray settings to match the paper loaded in the tray.
- Preprinting, perforation, and creasing may significantly affect the print quality and cause jams or other paper feed problems.
- Before loading the card stock on the tray, flex and fan the card stock to loosen them. Straighten the edges on a level surface.

Tips on using envelopes

- From the printer control panel, set the paper size, type, texture, and weight in the Paper menu to match the envelopes loaded in the tray.
- Print samples on the envelopes being considered for use before buying large quantities.
- Use envelopes designed specifically for laser printers.
- For best performance, use envelopes made from 90-g/m² (24-lb) paper or 25% cotton.
- Use only new envelopes from undamaged packages.
- To optimize performance and minimize jams, do not use envelopes that:
 - Have excessive curl or twist.
 - Are stuck together or damaged in any way.
 - Have windows, holes, perforations, cutouts, or embossing.
 - Have metal clasps, string ties, or folding bars.
 - Have an interlocking design.
 - Have postage stamps attached.
 - Have any exposed adhesive when the flap is in the sealed or closed position.

- Have bent corners.
- Have rough, cockle, or laid finishes.
- Adjust the width guides to fit the width of the envelopes.
- Before loading the envelopes on the tray, flex the stack of envelopes back and forth to loosen them, and then fan them. Straighten the edges on a level surface.

Note: A combination of high humidity (over 60%) and high printing temperature may wrinkle or seal envelopes.

Tips on using labels

- From the printer control panel, set the paper size, type, texture, and weight in the Paper menu to match the labels loaded in the tray.
- Print samples on labels being considered for use before buying large quantities.
- For more information on label printing, characteristics, and design, see the *Card Stock & Label Guide* on the Lexmark Web site at <http://support.lexmark.com>.
- Use labels designed specifically for laser printers.
- Do not use labels with slick backing material.
- Do not use labels with exposed adhesive.
- Use full label sheets. Partial sheets may cause labels to peel off during printing, resulting in a jam. Partial sheets also contaminate the printer and the cartridge with adhesive, and could void the printer and toner cartridge warranties.
- Before loading labels on the tray, flex and fan labels to loosen them. Straighten the edges on a level surface.

Tips on using letterhead

- Use letterhead specifically for laser printers.
- Print samples before buying large quantities.
- Before loading letterhead, flex and fan the sheets.
- When printing on letterhead, take note of the page orientation.

Source	Printing	Side with the letterhead	Paper orientation
Trays	One-sided	Faceup	Load the sheet with the top edge toward the back of the tray.
	Two-sided	Facedown	Load the sheet with the top edge toward the front of the tray.
Multipurpose feeder	One-sided	Facedown	Load the sheet with the top edge on the left side.
	Two-sided	Faceup	Load the sheet with the top edge on the right side.

Tips on using transparencies

- From the printer control panel, set the paper size, type, texture, and weight in the Paper menu to match the transparencies loaded in the tray.
- Print a test page on the transparencies being considered for use before buying large quantities.
- Use transparencies designed specifically for laser printers.
- Avoid getting fingerprints on the transparencies to prevent print quality problems.
- Before loading transparencies, flex and fan the sheets to prevent them from sticking together.
- When printing on large volumes of transparencies, make sure to print by batches of only up to 20 with an interval of at least three minutes between batches, to prevent the transparencies from sticking together in the bin. You can also remove transparencies from the bin by batches of 20.

Paper guidelines

Paper characteristics

The following paper characteristics affect print quality and reliability. Consider these factors before printing on them:

Weight

The printer trays can feed paper weights between 60–256 g/m² (16–68-lb) grain long paper. The multipurpose feeder can feed paper weights between 60–256 g/m² (16–68-lb) grain long paper. Paper lighter than 60 g/m² (16 lb) might not be stiff enough to feed properly, and may cause jams.

Note: Two-sided printing is supported for 60–169 g/m² (16–45-lb) paper.

Curl

Curl is the tendency for paper to curl at its edges. Excessive curl can cause paper feeding problems. Curl can occur after the paper passes through the printer, where it is exposed to high temperatures. Storing paper unwrapped in hot, humid, cold, or dry conditions, even in the trays, can contribute to paper curling prior to printing and can cause feeding problems.

Smoothness

Paper smoothness directly affects print quality. If paper is too rough, toner cannot fuse to it properly. If paper is too smooth, it can cause paper feeding or print quality issues. Always use paper between 100 and 200 Sheffield points.

Moisture content

The amount of moisture in paper affects both print quality and the ability of the printer to feed the paper correctly. Leave paper in its original wrapper until it is time to use it. This limits the exposure of paper to moisture changes that can degrade its performance.

Store paper in its original wrapper in the same environment as the printer for 24 to 48 hours before printing. Extend the time several days if the storage or transportation environment is very different from the printer environment. Thick paper may also require a longer conditioning period.

Grain direction

Grain refers to the alignment of the paper fibers in a sheet of paper. Grain is either *grain long*, running the length of the paper, or *grain short*, running the width of the paper.

For 60–256 g/m² (16–68-lb) paper, grain long paper is recommended.

Fiber content

Most high-quality xerographic paper is made from 100% chemically treated pulped wood. This content provides the paper with a high degree of stability, resulting in fewer paper feeding problems and better print quality. Paper containing fibers such as cotton can negatively affect paper handling.

Selecting paper

Using the appropriate paper prevents jams and helps ensure trouble-free printing.

To help avoid paper jams and poor print quality:

- *Always* use new, undamaged paper.
- Before loading paper, know the recommended printable side of the paper. This information is usually indicated on the paper package.
- *Do not* use paper that has been cut or trimmed by hand.
- *Do not* mix paper sizes, types, or weights in the same tray; mixing results in jams.
- *Do not* use coated papers unless they are specifically designed for electrophotographic printing.

Selecting preprinted forms and letterhead

- Use grain long for 60–256-g/m² (16–68-lb) paper.
- Use only forms and letterhead printed using an offset lithographic or engraved printing process.
- Avoid paper with rough or heavily textured surfaces.
- Use inks that are not affected by the resin in toner. Inks that are oxidation-set or oil-based generally meet these requirements; latex inks might not.
- Print samples on preprinted forms and letterheads considered for use before buying large quantities. This determines whether or not the ink in the preprinted form or letterhead will affect print quality.
- When in doubt, contact your paper supplier.

Using recycled paper and other office papers

As an environmentally conscientious company, Lexmark supports the use of recycled paper produced specifically for use in laser (electrophotographic) printers.

While no blanket statement can be made that all recycled paper will feed well, Lexmark consistently tests papers that represent recycled cut size copier papers available on the global market. This scientific testing is conducted with rigor and discipline. Many factors are taken into consideration both separately and as a whole, including the following:

- Amount of post-consumer waste (Lexmark tests up to 100% post-consumer waste content.)
- Temperature and humidity conditions (Testing chambers simulate climates from all over the world.)
- Moisture content (Business papers should have low moisture: 4–5%.)
- Bending resistance and proper stiffness means optimum feeding through the printer.

- Thickness (impacts how much can be loaded into a tray)
- Surface roughness (measured in Sheffield units, impacts print clarity and how well toner fuses to the paper)
- Surface friction (determines how easily sheets can be separated)
- Grain and formation (impacts curling, which also influences the mechanics of how the paper behaves as it moves through the printer)
- Brightness and texture (look and feel)

Recycled papers are better than ever; however, the amount of recycled content in a paper affects the degree of control over foreign matter. And while recycled papers are one good path to printing in an environmentally responsible manner, they are not perfect. The energy required to de-ink and deal with additives such as colorants and “glue” often generates more carbon emissions than does normal paper production. However, using recycled papers enables better resource management overall.

Lexmark concerns itself with the responsible use of paper in general based on life cycle assessments of its products. To gain a better understanding of the impact of printers on the environment, the company commissioned a number of life cycle assessments and found that paper was identified as the primary contributor (up to 80%) of carbon emissions caused throughout the entire life of a device (from design to end-of-life). This is due to the energy-intensive manufacturing processes required to make paper.

Thus, Lexmark seeks to educate customers and partners on minimizing the impact of paper. Using recycled paper is one way. Eliminating excessive and unnecessary paper consumption is another. Lexmark is well-equipped to help customers minimize printing and copying waste. In addition, the company encourages purchasing paper from suppliers who demonstrate their commitment to sustainable forestry practices.

Lexmark does not endorse specific suppliers, although a converter’s product list for special applications is maintained. However, the following paper choice guidelines will help alleviate the environmental impact of printing:

- 1** Minimize paper consumption.
- 2** Be selective about the origin of wood fiber. Buy from suppliers who carry certifications such as the Forestry Stewardship Council (FSC) or the Program for the Endorsement of Forest Certification (PEFC). These certifications guarantee that the paper manufacturer uses wood pulp from forestry operators that employ environmentally and socially responsible forest management and restoration practices.
- 3** Choose the most appropriate paper for printing needs: normal 75 or 80 g/m² certified paper, lower weight paper, or recycled paper.

Unacceptable paper examples

Test results indicate that the following paper types are at risk for use with laser printers:

- Chemically treated papers used to make copies without carbon paper, also known as *carbonless papers*
- Preprinted papers with chemicals that may contaminate the printer
- Preprinted papers that can be affected by the temperature in the printer fuser
- Preprinted papers that require a registration (the precise location on the page) greater than ± 2.3 mm (± 0.9 in.), such as optical character recognition (OCR) forms. In some cases, registration can be adjusted with a software application to successfully print on these forms.)
- Coated papers (erasable bond), synthetic papers, thermal papers
- Rough-edged, rough or heavily textured surface papers or curled papers
- Recycled papers that fail EN12281:2002 (European testing)
- Paper weighing less than 60 g/m² (16 lb)
- Multiple part forms or documents

For more information about Lexmark, visit www.lexmark.com. General sustainability-related information can be found at the **Environmental Sustainability** link.

Storing paper

Use these paper storage guidelines to help avoid jams and uneven print quality:

- For best results, store paper where the temperature is 21°C (70°F) and the relative humidity is 40 percent. Most label manufacturers recommend printing in a temperature range of 18–24°C (65–75°F) with relative humidity between 40 and 60 percent.
- Store paper in cartons, on a pallet or shelf, rather than on the floor.
- Store individual packages on a flat surface.
- Do not store anything on top of individual paper packages.
- Take paper out of the carton or wrapper only when you are ready to load it in the printer. The carton and wrapper help keep the paper clean, dry, and flat.

Supported paper sizes, types, and weights

Paper sizes supported by the printer

Paper size	Dimensions	Standard 500-sheet tray (Tray 1)	Standard 500-sheet tray (Tray 2)	2 x 500-sheet tray	2500-sheet tray	3000-sheet tray	Multipurpose feeder ³	Two-sided printing
A4	210 x 297 mm (8.3 x 11.7 in.)	✓	✓	✓	✓ ²	✓ ²	✓ ²	✓
A5	148 x 210 mm (5.8 x 8.3 in.)	✓ ¹	✓ ¹	✓ ¹	✗	✗	✓	✓
A6	105 x 148 mm (4.1 x 5.8 in.)	✗	✗	✗	✗	✗	✓ ¹	✓
JIS B5	182 x 257 mm (7.2 x 10.1 in.)	✓	✓	✓	✗	✗	✓	✓
Letter	216 x 279 mm (8.5 x 11 in.)	✓	✓	✓	✓ ²	✓ ²	✓	✓
Legal	216 x 356 mm (8.5 x 14 in.)	✓	✓	✓	✗	✗	✓	✓

¹ Supported only in short-edge orientation.

² Supported only in long-edge orientation.

³ Supports paper size without *size sensing*.

⁴ Supported only if the width is from 139.7 mm (5.5 in.) to 320 mm (12.6 in.), and the length is from 148 mm (5.83 in.) to 458 mm (18 in.).

Note: Banner is supported in the multipurpose feeder only if the width is up to 296.9 mm (11.69 in.) and the length is up to 1219.2 mm (48 in.). Set the paper size to Universal.

Paper size	Dimensions	Standard 500-sheet tray (Tray 1)	Standard 500-sheet tray (Tray 2)	2 x 500-sheet tray	2500-sheet tray	3000-sheet tray	Multipurpose feeder ³	Two-sided printing
Executive	184 x 267 mm (7.3 x 10.5 in.)	✓	✓	✓	X	X	✓	✓
JIS B4	257 x 364 mm (10.12 x 14.33 in.)	✓	✓	✓	X	X	✓	✓
SRA3	320 x 450 mm (12.6 x 17.7 in.)	X	✓ ¹	X	X	X	✓ ¹	✓
A3	297 x 420 mm (11.69 x 16.54 in.)	✓	✓	✓	X	X	✓	✓
12 x 18	305 x 457 mm (12 x 18 in.)	X	✓ ¹	X	X	X	✓ ¹	✓
11 x 17	279.4 x 431.8 mm (11 x 17 in.)	✓	✓	✓	X	X	✓	✓
Oficio	216 x 340 mm (8.5 x 13.4 in.)	✓	✓	✓	X	X	✓	✓
Folio	216 x 330 mm (8.5 x 13 in.)	✓	✓	✓	X	X	✓	✓
Statement	140 x 216 mm (5.5 x 8.5 in.)	✓ ¹	✓ ¹	✓ ¹	X	X	✓	✓
Universal	76.2 x 76.2 mm (3 x 3 in.) to 320 x 1219.2 mm (12.6 x 48 in.)	✓	✓	✓	X	X	✓	✓ ⁴
7 3/4 Envelope	98 x 191 mm (3.9 x 7.5 in.)	X	X	X	X	X	✓	X
9 Envelope	98 x 225 mm (3.9 x 8.9 in.)	X	X	X	X	X	✓	X
10 Envelope	105 x 241 mm (4.1 x 9.5 in.)	X	X	X	X	X	✓	X
DL Envelope	110 x 220 mm (4.3 x 8.7 in.)	X	X	X	X	X	✓	X
C5 Envelope	162 x 229 mm (6.4 x 9 in.)	X	X	X	X	X	✓	X

¹ Supported only in short-edge orientation.

² Supported only in long-edge orientation.

³ Supports paper size without *size sensing*.

⁴ Supported only if the width is from 139.7 mm (5.5 in.) to 320 mm (12.6 in.), and the length is from 148 mm (5.83 in.) to 458 mm (18 in.).

Note: Banner is supported in the multipurpose feeder only if the width is up to 296.9 mm (11.69 in.) and the length is up to 1219.2 mm (48 in.). Set the paper size to Universal.

Paper size	Dimensions	Standard 500-sheet tray (Tray 1)	Standard 500-sheet tray (Tray 2)	2 x 500-sheet tray	2500-sheet tray	3000-sheet tray	Multipurpose feeder ³	Two-sided printing
B5 Envelope	176 x 250 mm (6.9 x 9.8 in.)	X	X	X	X	X	✓	X
Other Envelope	98 x 162 mm (3.9 x 6.3 in.) to 176 x 250 mm (6.9 x 9.8 in.)	X	X	X	X	X	✓	X

¹ Supported only in short-edge orientation.

² Supported only in long-edge orientation.

³ Supports paper size without *size sensing*.

⁴ Supported only if the width is from 139.7 mm (5.5 in.) to 320 mm (12.6 in.), and the length is from 148 mm (5.83 in.) to 458 mm (18 in.).

Note: Banner is supported in the multipurpose feeder only if the width is up to 296.9 mm (11.69 in.) and the length is up to 1219.2 mm (48 in.). Set the paper size to Universal.

Paper types and weights supported by the printer

The printer engine supports 60–256-g/m² (16–68-lb) paper weights.

Note: Labels, transparencies, envelopes, and card stock always print at reduced speed.

Paper type	Standard 500-sheet tray (Tray 1)	Standard 500-sheet tray (Tray 2)	2 x 500-sheet tray	2500-sheet tray	3000-sheet tray	Multipurpose feeder
Plain Paper¹	✓	✓	✓	✓	✓	✓
Card Stock	✓	✓	✓	✓	✓	✓
Transparencies²	X	X	X	X	X	✓
Recycled¹	✓	✓	✓	✓	✓	✓
Glossy	✓	✓	✓	✓	✓	✓
Heavy Glossy	✓	✓	✓	✓	✓	✓
Labels	X	X	X	X	X	✓
Bond¹	✓	✓	✓	✓	✓	✓
Envelope	X	X	X	X	X	✓
Rough Envelope	X	X	X	X	X	✓

¹ Paper is supported for two-sided printing.

² Print transparencies in batches of only up to 20 to prevent them from sticking together. For more information, see [“Tips on using transparencies” on page 56](#).

Paper type	Standard 500-sheet tray (Tray 1)	Standard 500-sheet tray (Tray 2)	2 x 500-sheet tray	2500-sheet tray	3000-sheet tray	Multipurpose feeder
Letterhead ¹	✓	✓	✓	✓	✓	✓
Preprinted ¹	✓	✓	✓	✓	✓	✓
Colored Paper ¹	✓	✓	✓	✓	✓	✓
Light Paper ¹	✓	✓	✓	✓	✓	✓
Heavy Paper ¹	✓	✓	✓	✓	✓	✓
Rough Cotton	✓	✓	✓	✓	✓	✓
Custom Type ¹	✓	✓	✓	✓	✓	✓

¹ Paper is supported for two-sided printing.

² Print transparencies in batches of only up to 20 to prevent them from sticking together. For more information, see [“Tips on using transparencies” on page 56](#).

Paper sizes, types, and weights supported by the finishers

The printer engine supports 60–256 g/m² (16–68-lb) paper weights.

Note: When a finisher is installed, the standard finisher bin becomes the default bin even for print jobs that do not require finishing.

Supported paper sizes

Paper size	Staple finisher	Staple, hole punch finisher bin 1	Staple, hole punch finisher bin 2	Booklet finisher
A6	✓ ³	✓ ³	X	X
A5	✓ ³	✓ ³	✓ ²	X
JIS B5	✓	✓	✓	X
JIS B4	✓	✓	✓	✓
Executive	✓	✓	✓	X
Letter	✓	✓	✓	✓
A4	✓	✓	✓	✓

¹ Paper is supported only if the finisher stacks the paper but does not staple or punch holes in it.

² Paper is supported only if the finisher stacks or staples the paper but does not punch holes in it.

³ Paper is supported but the finisher does not stack, staple, or punch holes in it.

⁴ Paper is supported only for 2-hole punch.

⁵ Paper is supported only if the paper size is between 210 x 279.4 mm (8.27 x 11 in.) and 320 x 457.2 mm (12.6 x 18 in.).

Paper size	Staple finisher	Staple, hole punch finisher bin 1	Staple, hole punch finisher bin 2	Booklet finisher
Legal	✓	✓ ⁴	✓	✓
12 x 18	✓ ¹	✓ ³	✓ ¹	✓
11 x 17	✓	✓	✓	✓
SRA3	✓ ¹	✓ ³	✓ ¹	✓
A3	✓	✓	✓	✓
Oficio	✓ ¹	✓ ³	✓ ³	X
Folio	✓ ¹	✓ ³	✓ ³	X
Statement	✓ ¹	✓ ³	✓ ³	X
Universal	✓	✓ ³	✓ ¹	✓ ⁵

¹ Paper is supported only if the finisher stacks the paper but does not staple or punch holes in it.

² Paper is supported only if the finisher stacks or staples the paper but does not punch holes in it.

³ Paper is supported but the finisher does not stack, staple, or punch holes in it.

⁴ Paper is supported only for 2-hole punch.

⁵ Paper is supported only if the paper size is between 210 x 279.4 mm (8.27 x 11 in.) and 320 x 457.2 mm (12.6 x 18 in.).

Supported paper types

Paper type	Staple finisher	Staple, hole punch finisher	Booklet finisher
Plain Paper	✓	✓	✓ ⁵
Card Stock	✓ ²	✓	X
Transparency ¹	✓ ²	✓ ³	X
Recycled	✓ ²	✓	✓ ⁵
Glossy	✓ ²	✓	✓ ⁵
Heavy Glossy	✓ ²	✓ ⁴	X
Labels	✓ ²	✓ ³	X
Bond	✓	✓	✓ ⁵

¹ Print on transparencies by batches of only up to 20 to prevent them from sticking together. For more information, see [“Tips on using transparencies” on page 56](#).

² Paper is supported only if the finisher stacks the paper but does not staple it.

³ Paper is supported only if the finisher stacks the paper but does not staple or punch holes in it.

⁴ Paper is supported only if the finisher punches holes or stacks the paper but does not staple it.

⁵ Paper is supported only if the finisher staples or folds the paper.

Paper type	Staple finisher	Staple, hole punch finisher	Booklet finisher
Envelope	√ ²	√ ³	X
Rough Envelope	√ ²	√ ³	X
Letterhead	√	√	√ ⁵
Preprinted	√	√	√ ⁵
Colored Paper	√	√	√ ⁵
Light Paper	√	√	√ ⁵
Heavy Paper	√ ²	√ ⁴	X
Rough Cotton	√ ²	√	X
Custom Type	√	√	√ ⁵

¹ Print on transparencies by batches of only up to 20 to prevent them from sticking together. For more information, see [“Tips on using transparencies” on page 56](#).

² Paper is supported only if the finisher stacks the paper but does not staple it.

³ Paper is supported only if the finisher stacks the paper but does not staple or punch holes in it.

⁴ Paper is supported only if the finisher punches holes or stacks the paper but does not staple it.

⁵ Paper is supported only if the finisher staples or folds the paper.

Printing

Printing forms and a document

Printing forms

Use Forms and Favorites to quickly and easily access frequently used forms or other information that is regularly printed. Before you can use this application, first set it up on the printer. For more information, see [“Setting up Forms and Favorites” on page 19](#).

- 1 From the home screen, navigate to:
Forms and Favorites > select the form from the list > enter the number of copies > adjust other settings
- 2 Apply the changes.

Printing from a computer

Note: For specialty media such as labels, card stock, and envelopes, set the paper size and type in the printer before sending the print job.

- 1 With a document open, click **File** > **Print**.
- 2 If necessary, adjust the settings.
- 3 Send the print job.

Adjusting toner darkness

- 1 From the home screen, navigate to:
 > **Settings** > **Print Settings** > **Quality Menu**
- 2 Adjust the toner darkness setting, and then save the changes.

Printing from a flash drive or mobile device

Printing from a flash drive

Printing from a flash drive

Notes:

- Before printing an encrypted PDF file, you are prompted to type the file password from the control panel.
- You cannot print files for which you do not have printing permissions.

1 Insert a flash drive into the USB port.

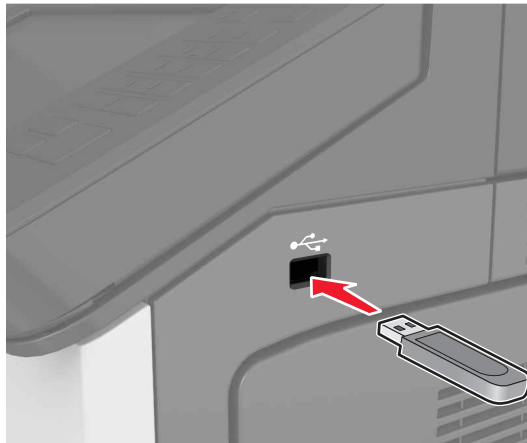

Notes:

- A flash drive icon appears on the printer home screen when a flash drive is inserted.
- If you insert the flash drive when the printer requires attention, such as when a jam has occurred, then the printer ignores the flash drive.
- If you insert the flash drive while the printer is processing other print jobs, then **Busy** appears on the printer display. After these print jobs are processed, you may need to view the held jobs list to print documents from the flash drive.

Warning—Potential Damage: Do not touch the printer or the flash drive in the area shown while actively printing, reading, or writing from the memory device. Loss of data or a malfunction can occur.



2 From the control panel, touch the document you want to print.

3 Specify the number of copies to be printed, and then send the job for printing.

Notes:

- Do not remove the flash drive from the USB port until the document has finished printing.
- If you leave the flash drive in the printer after leaving the initial USB menu screen, then touch **Held Jobs** on the home screen to print files from the flash drive.

Supported flash drives and file types

Notes:

- High-speed USB flash drives must support the full-speed standard. Low-speed USB devices are not supported.
- USB flash drives must support the File Allocation Table (FAT) system. Devices formatted with New Technology File System (NTFS) or any other file system are not supported.

Recommended flash drives	File type
<ul style="list-style-type: none"> • Lexar FireFly (512MB and 1GB) • SanDisk Cruzer Micro (512MB and 1GB) • Sony (512MB and 1GB) 	<p>Documents:</p> <ul style="list-style-type: none"> • .pdf • .xps <p>Images:</p> <ul style="list-style-type: none"> • .dcx • .gif • .jpeg or .jpg • .bmp • .pcx • .tiff or .tif • .png

Printing from a mobile device

To download a compatible mobile printing application, visit www.lexmark.com/mobile.

Note: Mobile printing applications may also be available from your mobile device manufacturer.

Printing confidential and other held jobs

Storing print jobs in the printer

1 From the home screen, navigate to:

 > **Security** > **Confidential Print** > select a print job type

Use	To
Max Invalid PIN	Limit the number of times an invalid PIN can be entered. Note: When the limit is reached, the print jobs for that user name and PIN are deleted.
Confidential Job Expiration	Hold print jobs in the computer until you enter the PIN from the printer control panel. Note: The PIN is set from the computer. It must be four digits, using the numbers 0–9.
Repeat Job Expiration	Print and store print jobs in the printer memory.
Verify Job Expiration	Print one copy of a print job and hold the remaining copies. It lets you examine if the first copy is satisfactory or not. The print job is automatically deleted from the printer memory when all copies are printed.
Reserve Job Expiration	Store print jobs for printing at a later time. Note: The print jobs are held until deleted from the Held Jobs menu.
Notes: <ul style="list-style-type: none"> • Confidential, Verify, Reserve, and Repeat print jobs may be deleted if the printer requires extra memory to process additional held jobs. • You can set the printer to store print jobs in the printer memory until you start the print job from the printer control panel. • All print jobs that can be initiated by the user at the printer are called <i>held jobs</i>. 	

2 Touch .

Printing held jobs

- 1 With a document open, select **File > Print**.
- 2 Select the printer, and then do the following:
 - For Windows users, click **Properties** or **Preferences**, and then click **Print and Hold**.
 - For Macintosh users, select **Print and Hold**.
- 3 Select the print job type.
- 4 If necessary, assign a user name.
- 5 Send the print job.
- 6 From the printer home screen, touch **Held Jobs**.
- 7 Send the print job.

Modifying confidential print settings

Note: This feature is available only in network printers or printers connected to print servers.

- 1 Open a Web browser, and then type the printer IP address in the address field.

Notes:

- View the printer IP address in the TCP/IP section in the Network/Ports menu. The IP address appears as four sets of numbers separated by periods, such as 123.123.123.123.
- If you are using a proxy server, then temporarily disable it to load the Web page correctly.

2 Click **Settings** tab > **Security** > **Confidential Print Setup**.

3 Modify the settings:

- Set a maximum number of PIN entry attempts. When a user exceeds a specific number of PIN entry attempts, all of the jobs for that user are deleted.
- Set an expiration time for confidential print jobs. When a user has not printed the jobs within the specified time, all of the jobs for that user are deleted.

4 Save the modified settings.

Printing information pages

Printing a font sample list

1 From the home screen, navigate to:



> **Reports** > **Print Fonts**

2 Touch **PCL Fonts** or **PostScript Fonts**.

Printing a directory list

A directory list shows the resources stored in a flash memory or in the printer hard disk.

From the home screen, navigate to:



> **Reports** > **Print Directory**

Canceling a print job

Canceling a print job from the printer control panel

1 From the printer control panel, touch **Cancel Job** or press  on the keypad.

2 Touch the print job you want to cancel, and then touch **Delete Selected Jobs**.

Note: If you press  on the keypad, then touch **Resume** to return to the home screen.

Canceling a print job from the computer

- 1 Depending on the operating system, do either of the following:
 - Open the printers folder, and then select your printer.
 - From the System Preferences in the Apple menu, navigate to your printer.
- 2 Select the print job to cancel.

Understanding the printer menus

Menus list

Paper Menu

- Default Source
- Paper Size/Type
- Configure MP
- Substitute Size
- Paper Texture
- Paper Loading
- Custom Types
- Custom Names
- Custom Bin Names
- Universal Setup
- Bin Setup

Security

- Miscellaneous Security Settings
- Confidential Print
- Erase Temporary Data Files
- Security Audit Log
- Set Date and Time

Reports

- Menu Settings Page
- Device Statistics
- Stapler Test
- Network Setup Page ¹
- Profiles List
- Print Fonts
- Print Directory
- Asset Report
- Event Log Summary

Settings

- General Settings
- Flash Drive Menu
- Print Settings

Network/Ports

- Active NIC
- Standard Network ²
- Standard USB
- Parallel [x]
- Serial [x]
- SMTP Setup

Help

- Print All Guides
- Print Quality
- Printing Guide
- Media Guide
- Print Defects Guide
- Menu Map
- Information Guide
- Connection Guide
- Moving Guide
- Supplies Guide

Option Card Menu³

A list of installed DLEs (Download Emulators) appears.

¹ Depending on the printer setup, this menu item appears as Network Setup Page or Network [x] Setup Page.

² Depending on the printer setup, this menu item appears as Standard Network or Network [x].

³ This menu appears only when one or more DLEs are installed.

Paper menu

Default Source menu

Use	To
<p>Default Source</p> <ul style="list-style-type: none"> Tray [x] Multipurpose Feeder Manual Paper Manual Envelope 	<p>Set a default paper source for all print jobs.</p> <p>Notes:</p> <ul style="list-style-type: none"> • Tray 1 (standard tray) is the factory default setting. • From the Paper menu, set Configure MP to "Cassette" for Multipurpose Feeder to appear as a menu setting. • If two trays contain paper of the same size and type, and the trays have the same settings, then the trays are automatically linked. When one tray is empty, the print job continues using the linked tray.

Paper Size/Type menu

Use	To
<p>Tray [x] Size</p> <ul style="list-style-type: none"> A4 A5 A6 JIS-B5 JIS-B4 Letter Legal 12 x 18 11 x 17 SRA3 A3 Executive Oficio (Mexico) Folio Statement Universal 	<p>Specify the paper size loaded in each tray.</p> <p>Notes:</p> <ul style="list-style-type: none"> • Letter is the U.S. factory default setting. A4 is the international factory default setting. • If two trays contain paper of the same size and type, and the trays have the same settings, then the trays are automatically linked. The multipurpose feeder may also be linked. When one tray is empty, the print job continues using the linked tray.

Note: Only installed trays and feeders are listed in this menu.

Use	To
<p>Tray [x] Type</p> <ul style="list-style-type: none"> Plain Paper Card Stock Transparency Recycled Glossy Heavy Glossy Labels Bond Envelope Rough Envelope Letterhead Preprinted Colored Paper Light Paper Heavy Paper Rough/Cotton Custom Type [x] 	<p>Specify the type of paper loaded in each tray.</p> <p>Notes:</p> <ul style="list-style-type: none"> • Plain Paper is the factory default setting for Tray 1. Custom Type [x] is the factory default setting for all other trays. • If available, a user-defined name appears instead of Custom Type [x]. • Use this menu to configure automatic tray linking.
<p>MP Feeder Size</p> <ul style="list-style-type: none"> A4 A5 A6 JIS-B5 JIS-B4 Letter Legal 12 x 18 11 x 17 SRA3 A3 Executive Oficio (Mexico) Folio Statement Universal 	<p>Specify the paper size loaded in the multipurpose feeder.</p> <p>Notes:</p> <ul style="list-style-type: none"> • Letter is the U.S. factory default setting. A4 is the international factory default setting. • From the Paper menu, set Configure MP to “Cassette” for MP Feeder Size to appear as a menu. • The multipurpose feeder does not automatically detect paper size. The paper size value must be set.
<p>Note: Only installed trays and feeders are listed in this menu.</p>	

Use	To
<p>MP Feeder Type</p> <ul style="list-style-type: none"> Plain Paper Card Stock Transparency Recycled Glossy Heavy Glossy Labels Bond Envelope Rough Envelope Letterhead Preprinted Colored Paper Light Paper Heavy Paper Rough/Cotton Custom Type [x] 	<p>Specify the paper type loaded in the multipurpose feeder.</p> <p>Notes:</p> <ul style="list-style-type: none"> • Plain Paper is the factory default setting. • From the Paper menu, set Configure to “Cassette” for MP Feeder Type to appear as a menu.
<p>Manual Paper Size</p> <ul style="list-style-type: none"> A4 A5 A6 JIS B5 Letter Legal Executive Oficio (Mexico) JIS B4 A3 11 x 17 Folio Statement Universal SRA3 12 x 18 	<p>Specify the size of the paper being manually loaded.</p> <p>Note: Letter is the U.S. factory default setting. A4 is the international factory default setting.</p>
<p>Note: Only installed trays and feeders are listed in this menu.</p>	

Use	To
<p>Manual Paper Type</p> <ul style="list-style-type: none"> Plain Paper Card Stock Transparency Recycled Labels Bond Letterhead Preprinted Colored Paper Light Paper Heavy Paper Rough/Cotton Custom Type [x] 	<p>Specify the paper type being manually loaded.</p> <p>Notes:</p> <ul style="list-style-type: none"> • Plain Paper is the factory default setting. • From the Paper menu, set Configure MP to “Manual” for Manual Paper Type to appear as a menu.
<p>Manual Envelope Size</p> <ul style="list-style-type: none"> 7 3/4 Envelope 9 Envelope 10 Envelope DL Envelope C5 Envelope B5 Envelope Other Envelope 	<p>Specify the envelope size being manually loaded.</p> <p>Note: 10 Envelope is the U.S. factory default setting. DL Envelope is the international factory default setting.</p>
<p>Manual Envelope Type</p> <ul style="list-style-type: none"> Envelope Rough Envelope Custom Type [x] 	<p>Specify the envelope type being manually loaded.</p> <p>Note: Envelope is the factory default setting.</p>
<p>Note: Only installed trays and feeders are listed in this menu.</p>	

Configure MP menu

Use	To
<p>Configure MP</p> <ul style="list-style-type: none"> Cassette Manual First 	<p>Determine when the printer selects paper from the multipurpose feeder.</p> <p>Notes:</p> <ul style="list-style-type: none"> • Cassette is the factory default setting. Cassette configures the multipurpose feeder as the automatic paper source. • Manual sets the multipurpose feeder only for manual-feed print jobs. • First configures the multipurpose feeder as the primary paper source.

Substitute Size menu

Use	To
<p>Substitute Size</p> <ul style="list-style-type: none"> Off Statement/A5 Letter/A4 11 x 17/A3 All Listed 	<p>Substitute a specified paper size if the requested paper size is not available.</p> <p>Notes:</p> <ul style="list-style-type: none"> • All Listed is the factory default setting. All available substitutions are allowed. • Setting a size substitution lets the print job continue without Change Paper appearing.

Paper Texture menu

Use	To
<p>Plain Texture</p> <ul style="list-style-type: none"> Smooth Normal Rough 	<p>Specify the relative texture of the plain paper loaded.</p> <p>Note: Normal is the factory default setting.</p>
<p>Card Stock Texture</p> <ul style="list-style-type: none"> Smooth Normal Rough 	<p>Specify the relative texture of the card stock loaded.</p> <p>Notes:</p> <ul style="list-style-type: none"> • Normal is the factory default setting. • The options appear only if card stock is supported.
<p>Transparency Texture</p> <ul style="list-style-type: none"> Smooth Normal Rough 	<p>Specify the relative texture of the transparencies loaded.</p> <p>Note: Normal is the factory default setting.</p>
<p>Recycled Texture</p> <ul style="list-style-type: none"> Smooth Normal Rough 	<p>Specify the relative texture of the recycled paper loaded.</p> <p>Note: Normal is the factory default setting.</p>
<p>Labels Texture</p> <ul style="list-style-type: none"> Smooth Normal Rough 	<p>Specify the relative texture of the labels loaded.</p> <p>Note: Normal is the factory default setting.</p>
<p>Bond Texture</p> <ul style="list-style-type: none"> Smooth Normal Rough 	<p>Specify the relative texture of the bond paper loaded.</p> <p>Note: Rough is the factory default setting.</p>
<p>Envelope Texture</p> <ul style="list-style-type: none"> Smooth Normal Rough 	<p>Specify the relative texture of the envelopes loaded.</p> <p>Note: Normal is the factory default setting.</p>

Use	To
Rough Envelope Texture Rough	Specify the relative texture of the rough envelopes loaded.
Letterhead Texture Smooth Normal Rough	Specify the relative texture of the letterhead loaded. Note: Normal is the factory default setting.
Preprinted Texture Smooth Normal Rough	Specify the relative texture of the preprinted paper loaded. Note: Normal is the factory default setting.
Colored Texture Smooth Normal Rough	Specify the relative texture of the colored paper loaded. Note: Normal is the factory default setting.
Light Texture Smooth Normal Rough	Specify the relative texture of the paper loaded. Note: Normal is the factory default setting.
Heavy Texture Smooth Normal Rough	Specify the relative texture of the paper loaded. Note: Normal is the factory default setting.
Rough/Cotton Texture Rough	Specify the relative texture of the cotton paper loaded.
Custom [x] Texture Smooth Normal Rough	Specify the relative texture of the custom paper loaded. Notes: <ul style="list-style-type: none"> • Normal is the factory default setting. • The options appear only if the custom type is supported.

Paper Loading menu

Use	To
Card Stock Loading Duplex Off	Determine and set two-sided printing for all print jobs with Card Stock as the paper type.
Notes: <ul style="list-style-type: none"> • Off is the factory default setting for all Paper Loading menu selections. • Duplex sets the printer default to two-sided printing for every print job unless one-sided printing is selected from Print Properties or the print dialog, depending on your operating system. 	

Use	To
Recycled Loading Duplex Off	Determine and set two-sided printing for all print jobs with Recycled as the paper type.
Glossy Loading Duplex Off	Determine and set two-sided printing for all print jobs with Glossy as the paper type.
Heavy Glossy Loading Duplex Off	Determine and set two-sided printing for all print jobs with Heavy Glossy as the paper type.
Labels Loading Duplex Off	Determine and set two-sided printing for all print jobs with Labels as the paper type.
Bond Loading Duplex Off	Determine and set two-sided printing for all print jobs with Bond as the paper type.
Letterhead Loading Duplex Off	Determine and set two-sided printing for all print jobs with Letterhead as the paper type.
Preprinted Loading Duplex Off	Determine and set two-sided printing for all print jobs with Preprinted as the paper type.
Colored Loading Duplex Off	Determine and set two-sided printing for all print jobs with Colored as the paper type.
Light Loading Duplex Off	Determine and set two-sided printing for all print jobs with Light as the paper type.
Heavy Loading Duplex Off	Determine and set two-sided printing for all print jobs with Heavy as the paper type.
Rough/Cotton Loading Duplex Off	Determine and set two-sided printing for all print jobs with Rough or Cotton as the paper type.
Custom [x] Loading Duplex Off	Determine and set two-sided printing for all print jobs with Custom [x] as the paper type. Note: Custom [x] Loading is available only when the custom type is supported.
Notes: <ul style="list-style-type: none"> • Off is the factory default setting for all Paper Loading menu selections. • Duplex sets the printer default to two-sided printing for every print job unless one-sided printing is selected from Print Properties or the print dialog, depending on your operating system. 	

Custom Types menu

Use	To
Custom Type [x] Paper Card Stock Transparency Rough/Cotton Labels Envelope	Associate a paper or specialty media type with a factory default custom type name or a user-defined custom name created from the Embedded Web Server or from MarkVision™ Professional. Notes: <ul style="list-style-type: none"> • Paper is the factory default setting. • The custom media type must be supported by the selected tray or multipurpose feeder in order to print from that source.
Recycled Paper Card Stock Transparency Rough/Cotton Labels Envelope	Specify a paper type when Recycled is selected in other menus. Notes: <ul style="list-style-type: none"> • Paper is the factory default setting. • The custom media type must be supported by the selected tray or multipurpose feeder in order to print from that source.

Custom Names menu

Use	To
Custom Name [x]	Specify a custom name for a paper type. This name replaces Custom Type [x] in the printer menus.

Custom Bin Names menu

Use	To
Standard Bin	Specify a custom name for the standard bin.
Bin [x]	Specify a custom name for Bin [x].

Universal Setup menu

Use	To
Units of Measure Inches Millimeters	Identify the units of measure. Notes: <ul style="list-style-type: none"> • Inches is the U.S. factory default setting. • Millimeters is the international factory default setting.

Use	To
<p>Portrait Width 3.54–48 inches 89.9–1219 mm</p>	<p>Set the portrait width.</p> <p>Notes:</p> <ul style="list-style-type: none"> • If the width exceeds the maximum, then the printer uses the maximum width allowed. • 12 inches is the U.S. factory default setting. You can increase the width in 0.01-inch increments. • 305 mm is the international factory default setting. You can increase the width in 1-mm increments.
<p>Portrait Height 5.5–48 inches 139.7–1219 mm</p>	<p>Set the portrait height.</p> <p>Notes:</p> <ul style="list-style-type: none"> • If the height exceeds the maximum, then the printer uses the maximum height allowed. • 17 inches is the U.S. factory default setting. You can increase the height in 0.01-inch increments. • 432 mm is the international factory default setting. You can increase the height in 1-mm increments.
<p>Feed Direction Short Edge Long Edge</p>	<p>Specify the feed direction if the paper can be loaded in either direction.</p> <p>Notes:</p> <ul style="list-style-type: none"> • Short Edge is the factory default setting. • Long Edge appears only when the longest edge is shorter than the maximum width supported in the tray.

Bin Setup menu

Use	To
<p>Output Bin Standard Bin Bin [x]*</p>	<p>Specify the default bin.</p> <p>Note: Standard Bin is the factory default setting.</p>
<p>Configure Bins Mailbox Link Link Optional Type Assignment</p>	<p>Specify configuration options for bins.</p> <p>Notes:</p> <ul style="list-style-type: none"> • Mailbox is the factory default setting. This treats each bin as a separate mailbox. • Link configures all available bins as one large bin. • Link Optional links together all available bins except the standard bin and only appears when at least two optional bins are installed. • Type Assignment assigns each paper type to a bin or linked bin set.

* [x] can be any number from 1 to 4 if the appropriate optional bins are installed. If multiple bins are assigned the same name, then the name appears only once in the bin list.

Use	To
<p>Overflow Bin</p> <p>Standard Bin</p> <p>Bin [x]*</p>	<p>Specify an alternative bin when a designated bin is full.</p> <p>Notes:</p> <ul style="list-style-type: none"> • This menu appears only when optional bins are installed. • Standard Bin is the factory default setting.
<p>Assign Type/Bin</p> <p>Plain Paper Bin</p> <p>Card Stock Bin</p> <p>Transparency Bin</p> <p>Recycled Bin</p> <p>Glossy Bin</p> <p>Heavy Glossy Bin</p> <p>Labels Bin</p> <p>Bond Bin</p> <p>Envelope Bin</p> <p>Rough Envelope Bin</p> <p>Letterhead Bin</p> <p>Preprinted Bin</p> <p>Colored Bin</p> <p>Light Paper Bin</p> <p>Heavy Paper Bin</p> <p>Rough/Cotton Bin</p> <p>Custom [x] Bin</p>	<p>Select a bin for each supported paper type.</p> <p>For each type, select from the following options:</p> <p>Disabled</p> <p>Standard Bin</p> <p>Bin [x]*</p> <p>Note: Disabled is the factory default setting.</p>
<p>* [x] can be any number from 1 to 4 if the appropriate optional bins are installed. If multiple bins are assigned the same name, then the name appears only once in the bin list.</p>	

Reports menu

Reports menu

Use	To
<p>Menu Settings Page</p>	<p>Print a report containing information about the paper loaded in trays, installed memory, total page count, alarms, timeouts, control panel language, TCP/IP address, status of supplies, status of the network connection, and other information.</p>
<p>Device Statistics</p>	<p>Print a report containing printer statistics such as supply information and details about printed pages.</p>
<p>Stapler Test</p>	<p>Print a report that confirms that the staple finisher is functioning properly.</p> <p>Note: This menu item appears only when a supported staple finisher is installed.</p>

Use	To
Network Setup Page	Print a report containing information about the network printer settings, such as the TCP/IP address information. Note: This menu item appears only in network printers or in printers connected to print servers.
Network [x] Setup Page	Print a report containing information about the network printer settings, such as the TCP/IP address information. Notes: <ul style="list-style-type: none"> • This menu item is available only when more than one network option is installed. • This menu item appears only in network printers or in printers connected to print servers.
Profiles List	Print a list of profiles stored in the printer. Note: This menu item appears only when LDSS is enabled.
Print Fonts PCL Fonts PostScript Fonts	Print a report of all the fonts available for the printer language currently set in the printer. Note: A separate list is available for PCL and PostScript emulations.
Print Directory	Print a list of all the resources stored in an optional flash memory card or printer hard disk. Notes: <ul style="list-style-type: none"> • Job Buffer Size must be set to 100%. • Make sure that the optional flash memory or hard disk is installed correctly and working properly. • This menu item appears only when an optional flash drive or hard disk is installed.
Asset Report	Print a report containing printer asset information, such as serial number and model name.
Event Log Summary	Print a report containing a summary of all logged events.

Network/Ports menu

Active NIC menu

Use	To
Active NIC Auto [list of available network cards]	Allow the printer to connect to a network. Notes: <ul style="list-style-type: none"> • Auto is the factory default setting. • This menu item appears only if an optional network adapter is installed.

Standard Network or Network [x] menu

Note: Only active ports appear in this menu.

Use	To
Energy Efficient Ethernet Enable Disable	Reduce power consumption when the printer receives no data from the Ethernet network. Note: Enable is the factory default setting.
PCL SmartSwitch On Off	Set the printer to automatically switch to PCL emulation when a print job requires it, regardless of the default printer language. Notes: <ul style="list-style-type: none"> • On is the factory default setting. • If PCL SmartSwitch is disabled, then the printer does not examine incoming data and it uses the default printer language specified in the Setup menu.
PS SmartSwitch On Off	Set the printer to automatically switch to PS emulation when a print job requires it, regardless of the default printer language. Notes: <ul style="list-style-type: none"> • On is the factory default setting. • If PS SmartSwitch is disabled, then the printer does not examine incoming data and it uses the default printer language specified in the Setup menu.
NPA Mode Off Auto	Set the printer to perform the special processing required for bidirectional communication following the conventions defined by the NPA protocol. Notes: <ul style="list-style-type: none"> • Auto is the factory default setting. • The printer automatically restarts when the setting is changed from the control panel.
Network Buffer Auto 3KB to [maximum size allowed]	Set the size of the network input buffer. Notes: <ul style="list-style-type: none"> • Auto is the factory default setting. • The maximum size allowed depends on the amount of memory in the printer, the size of the other link buffers, and whether Resource Save is set to On or Off. • To increase the maximum size range for the Network Buffer, disable or reduce the size of the parallel, serial, and USB buffers. • The printer automatically restarts when the setting is changed from the control panel.

Use	To
Job Buffering Off On Auto	Temporarily store print jobs in the printer hard disk before printing. This menu only appears when a formatted disk is installed. Notes: <ul style="list-style-type: none"> • Off is the factory default setting. • The printer automatically restarts when the setting is changed from the control panel. The menu selection is then updated.
Mac Binary PS On Off Auto	Set the printer to process Macintosh binary PostScript print jobs. Note: Auto is the factory default setting.
Standard Network Setup OR Network [x] Setup Reports Network Card TCP/IP IPv6 Wireless AppleTalk	Show and set the printer network settings. Note: The Wireless menu appears only when the printer is connected to a wireless network.

Reports menu

To access the menu, navigate to either of the following:

- **Network/Ports > Standard Network > Standard Network Setup > Reports**
- **Network/Ports > Network [x] > Network [x] Setup > Reports**

Use	To
Print Setup Page	Print a report containing information about the network printer settings, such as the TCP/IP address.

Network Card menu

To access the menu, navigate to either of the following:

- **Network/Ports > Standard Network > Standard Network Setup > Network Card**
- **Network/Ports > Network [x] > Network [x] Setup > Network Card**

Use	To
View Card Status Connected Disconnected	View the connection status of the wireless network adapter.
View Card Speed	View the speed of an active wireless network adapter.
Network Address UAA LAA	View the network addresses.

Use	To
Job Timeout 0, 10–225 seconds	Set the amount of time it takes for a network print job to be canceled. Notes: <ul style="list-style-type: none"> • “90 seconds” is the factory default setting. • A setting value of 0 disables the timeout. • If a value between 1 and 9 is selected, then Invalid appears on the display, and the value is not saved.
Banner Page Off On	Allow the printer to print a banner page. Note: Off is the factory default setting.

TCP/IP menu

To access the menu, navigate to either of the following:

- **Network/Ports > Standard Network > Standard Network Setup > TCP/IP**
- **Network/Ports > Network [x] > Network [x] Setup > TCP/IP**

Note: This menu is available only in network printers or printers attached to print servers.

Use	To
Set Hostname	Set the current TCP/IP host name. Note: This can be changed only from the Embedded Web Server.
IP Address	View or change the current TCP/IP address. Note: Manually setting the IP address sets the Enable DHCP and Enable Auto IP settings to Off. It also sets Enable BOOTP and Enable RARP to Off on systems that support BOOTP and RARP.
Netmask	View or change the current TCP/IP netmask.
Gateway	View or change the current TCP/IP gateway.
Enable DHCP On Off	Specify the DHCP address and parameter assignment. Note: On is the factory default setting.
Enable RARP On Off	Specify the RARP address assignment setting. Note: Off is the factory default setting.
Enable BOOTP On Off	Specify the BOOTP address assignment setting. Note: On is the factory default setting.
Enable AutoIP Yes No	Specify the Zero Configuration Networking setting. Note: Yes is the factory default setting.

Use	To
Enable FTP/TFTP Yes No	Enable the built-in FTP server, which lets you send files to the printer using File Transfer Protocol. Note: Yes is the factory default setting.
Enable HTTP Server Yes No	Enable the built-in Web server (Embedded Web Server). When enabled, the printer can be monitored and managed remotely using a Web browser. Note: Yes is the factory default setting.
WINS Server Address	View or change the current WINS server address.
Enable DDNS Yes No	View or change the current DDNS setting. Note: Yes is the factory default setting.
Enable mDNS Yes No	View or change the current mDNS setting. Note: Yes is the factory default setting.
DNS Server Address	View or change the current DNS server address.
Backup DNS Server Address	View or change the backup DNS server addresses.
Backup DNS Server Address 2	
Backup DNS Server Address 3	
Enable HTTPS Yes No	View or change the current HTTPS setting. Note: Yes is the factory default setting.

IPv6 menu

To access the menu, navigate to any of the following:

- **Network/Ports menu > Standard Network > Standard Network Setup > IPv6**
- **Network/Ports menu > Network [x] > Network [x] Setup > IPv6**

Note: This menu is available only in network printers or printers that are attached to print servers.

Use	To
Enable IPv6 On Off	Enable IPv6 in the printer. Note: On is the factory default setting.
Auto Configuration On Off	Specify whether or not the network adapter accepts the automatic IPv6 address configuration entries provided by a router. Note: On is the factory default setting.
Set Hostname	Set the host name.
View Address	Note: These settings can be changed only from the Embedded Web Server.
View Router Address	

Use	To
Enable DHCPv6 On Off	Enable DHCPv6 in the printer. Note: On is the factory default setting.

Wireless menu

Note: This menu is available only in printers connected to a wireless network or printer models that have a wireless network adapter.

To access the menu, navigate to:

Network/Ports > Network [x] > Network [x] Setup > Wireless

Use	To
Wi-Fi Protected Setup Start Push Button Method Start PIN Method	Establish a wireless network and enable network security. Notes: <ul style="list-style-type: none"> Start Push Button Method connects the printer to a wireless network when buttons on both the printer and the access point (wireless router) are pressed within a given period of time. Start PIN Method connects the printer to a wireless network when a PIN on the printer is entered into the wireless settings of the access point.
Enable/Disable WPS Auto-detection Enable Disable	Automatically detect the connection method that an access point with WPS uses—Start Push Button Method or Start PIN Method. Note: Disable is the factory default setting.
Network Mode BSS Type Infrastructure Ad hoc	Specify the network mode. Notes: <ul style="list-style-type: none"> Infrastructure is the factory default setting. This lets the printer access a network using an access point. Ad hoc configures wireless connection directly between the printer and a computer.
Compatibility 802.11b/g 802.11b/g/n	Specify the wireless standard for the wireless network. Note: 802.11b/g/n is the factory default setting.
Choose Network	Select an available network for the printer to use.
View Signal Quality	View the quality of the wireless connection.
View Security Mode	View the encryption method for the wireless network.

AppleTalk menu

To access the menu, navigate to either of the following:

- **Network/Ports > Standard Network > Standard Network Setup > AppleTalk**
- **Network/Ports > Network [x] > Network [x] Setup > AppleTalk**

Use	To
Activate Yes No	Enable or disable AppleTalk support. Note: No is the factory default setting.
View Name	Show the assigned AppleTalk name. Note: The AppleTalk name can be changed only from the Embedded Web Server.
View Address	Show the assigned AppleTalk address. Note: The AppleTalk address can be changed only from the Embedded Web Server.
Set Zone [list of zones available on the network]	Provide a list of AppleTalk zones available on the network. Note: The default zone for the network is the factory default setting.

Standard USB menu

Use	To
PCL SmartSwitch On Off	Set the printer to automatically switch to PCL emulation when a print job received through a USB port requires it, regardless of the default printer language. Notes: <ul style="list-style-type: none"> • On is the factory default setting. • When set to Off, the printer does not examine incoming data. The printer uses PostScript emulation if the PS SmartSwitch is set to On. It uses the default printer language specified in the Setup menu if the PS SmartSwitch is set to Off.
PS SmartSwitch On Off	Set the printer to automatically switch to PS emulation when a print job received through a USB port requires it, regardless of the default printer language. Notes: <ul style="list-style-type: none"> • On is the factory default setting. • When set to Off, the printer does not examine incoming data. The printer uses PCL emulation if the PCL SmartSwitch is set to On. It uses the default printer language specified in the Setup menu if the PCL SmartSwitch is set to Off.
NPA Mode On Off Auto	Set the printer to perform the special processing required for bidirectional communication following the conventions defined by the NPA protocol. Notes: <ul style="list-style-type: none"> • Auto is the factory default setting. Auto sets the printer to examine data, determine the format, and then process it appropriately. • The printer automatically restarts when changing the setting from the printer control panel. The menu selection is then updated.

Use	To
<p>USB Buffer</p> <p>Disabled Auto 3K to [maximum size allowed]</p>	<p>Set the size of the USB input buffer.</p> <p>Notes:</p> <ul style="list-style-type: none"> • Auto is the factory default setting. • Disabled turns off job buffering. Any jobs already buffered on the printer hard disk are printed before normal processing resumes. • The USB buffer size value can be changed in 1-K increments. • The maximum size allowed depends on the amount of memory in the printer, the size of the other link buffers, and whether Resource Save is set to On or Off. • To increase the maximum size range for the USB Buffer, disable or reduce the size of the parallel, serial, and network buffers. • The printer automatically restarts when the setting is changed from the printer control panel. The menu selection is then updated.
<p>Job Buffering</p> <p>Off On Auto</p>	<p>Temporarily store print jobs in the printer hard disk before printing.</p> <p>Notes:</p> <ul style="list-style-type: none"> • Off is the factory default setting. • On buffers jobs on the printer hard disk. • Auto buffers print jobs only if the printer is busy processing data from another input port. • Changing this setting from the printer control panel and then exiting the menus causes the printer to restart. The menu selection is then updated.
<p>Mac Binary PS</p> <p>On Off Auto</p>	<p>Set the printer to process Macintosh binary PostScript print jobs.</p> <p>Notes:</p> <ul style="list-style-type: none"> • Auto is the factory default setting. • On processes raw binary PostScript print jobs. • Off filters print jobs using the standard protocol.
<p>ENA Address</p> <p>yyy.yyy.yyy.yyy</p>	<p>Set the network address information for an external print server.</p> <p>Note: This menu is available only when the printer is attached to an external print server through the USB port.</p>
<p>ENA Netmask</p> <p>yyy.yyy.yyy.yyy</p>	<p>Set the netmask information for an external print server.</p> <p>Note: This menu is available only when the printer is attached to an external print server through the USB port.</p>
<p>ENA Gateway</p> <p>yyy.yyy.yyy.yyy</p>	<p>Set the gateway information for an external print server.</p> <p>Note: This menu is available only when the printer is attached to an external print server through the USB port.</p>

Parallel [x] menu

Note: This menu appears only when an optional parallel card is installed.

Use	To
<p>PCL SmartSwitch On Off</p>	<p>Set the printer to automatically switch to PCL emulation when a print job received through a serial port requires it, regardless of the default printer language.</p> <p>Notes:</p> <ul style="list-style-type: none"> • On is the factory default setting. • When set to Off, the printer does not examine incoming data. The printer uses PostScript emulation if PS SmartSwitch is set to On. It uses the default printer language specified in the Setup menu if PS SmartSwitch is set to Off.
<p>PS SmartSwitch On Off</p>	<p>Set the printer to automatically switch to PS emulation when a print job received through a serial port requires it, regardless of the default printer language.</p> <p>Notes:</p> <ul style="list-style-type: none"> • On is the factory default setting. • When set to Off, the printer does not examine incoming data. The printer uses PCL emulation if PCL SmartSwitch is set to On. It uses the default printer language specified in the Setup menu if PCL SmartSwitch is set to Off.
<p>NPA Mode On Off Auto</p>	<p>Set the printer to perform the special processing required for bidirectional communication following the conventions defined by the NPA protocol.</p> <p>Notes:</p> <ul style="list-style-type: none"> • Auto is the factory default setting. • Changing this setting from the printer control panel and then exiting the menus causes the printer to restart. The menu selection is then updated.
<p>Parallel Buffer Disabled Auto 3K to [maximum size allowed]</p>	<p>Set the size of the parallel input buffer.</p> <p>Notes:</p> <ul style="list-style-type: none"> • Auto is the factory default setting. • Disabled turns off job buffering. Any print jobs already buffered on the printer hard disk are printed before normal processing resumes. • The parallel buffer size setting can be changed in 1-KB increments. • The maximum size allowed depends on the amount of memory in the printer, the size of the other link buffers, and whether Resource Save is set to On or Off. • To increase the maximum size range for the Parallel Buffer, disable or reduce the size of the USB, serial, and network buffers. • Changing this setting from the printer control panel and then exiting the menus causes the printer to restart. The menu selection is then updated.

Use	To
<p>Job Buffering</p> <ul style="list-style-type: none"> Off On Auto 	<p>Temporarily store print jobs on the printer hard disk before printing.</p> <p>Notes:</p> <ul style="list-style-type: none"> • Off is the factory default setting. • On buffers print jobs on the printer hard disk. • Auto buffers print jobs only if the printer is busy processing data from another input port. • Changing this setting from the printer control panel and then exiting the menus causes the printer to restart. The menu selection is then updated.
<p>Advanced Status</p> <ul style="list-style-type: none"> On Off 	<p>Enable bidirectional communication through the parallel port.</p> <p>Notes:</p> <ul style="list-style-type: none"> • On is the factory default setting. • Off disables parallel port negotiation.
<p>Protocol</p> <ul style="list-style-type: none"> Standard Fastbytes 	<p>Specify the parallel port protocol.</p> <p>Notes:</p> <ul style="list-style-type: none"> • Fastbytes is the factory default setting. It provides compatibility with most existing parallel ports and is the recommended setting. • Standard tries to resolve parallel port communication problems.
<p>Honor Init</p> <ul style="list-style-type: none"> On Off 	<p>Determine if the printer honors printer hardware initialization requests from the computer.</p> <p>Notes:</p> <ul style="list-style-type: none"> • Off is the factory default setting. • The computer requests initialization by activating the Init signal from the parallel port. Many personal computers activate the Init signal each time the computer is turned on.
<p>Parallel Mode 2</p> <ul style="list-style-type: none"> On Off 	<p>Determine if the parallel port data is sampled on the leading or trailing edge of a strobe.</p> <p>Note: On is the factory default setting.</p>
<p>Mac Binary PS</p> <ul style="list-style-type: none"> On Off Auto 	<p>Set the printer to process Macintosh binary PostScript print jobs.</p> <p>Notes:</p> <ul style="list-style-type: none"> • Auto is the factory default setting. • Off filters print jobs using the standard protocol. • On processes raw binary PostScript print jobs.
<p>ENA Address</p> <p>yyy.yyy.yyy.yyy</p>	<p>Set the network address information for an external print server.</p> <p>Note: This menu item is available only if the printer is attached to an external print server through the USB port.</p>
<p>ENA Netmask</p> <p>yyy.yyy.yyy.yyy</p>	<p>Set the netmask information for an external print server.</p> <p>Note: This menu item is available only if the printer is attached to an external print server through the USB port.</p>

Use	To
ENA Gateway YYY.YYY.YYY.YYY	Set the gateway information for an external print server. Note: This menu item is available only if the printer is attached to an external print server through the USB port.

Serial [x] menu

Note: This menu appears only when an optional serial card is installed.

Use	To
PCL SmartSwitch On Off	Set the printer to automatically switch to PCL emulation when a print job received through a serial port requires it, regardless of the default printer language. Notes: <ul style="list-style-type: none"> • On is the factory default setting. • When set to Off, the printer does not examine incoming data. The printer uses PostScript emulation if PS SmartSwitch is set to On. It uses the default printer language specified in the Setup menu if PS SmartSwitch is set to Off.
PS SmartSwitch On Off	Set the printer to automatically switch to PS emulation when a print job received through a serial port requires it, regardless of the default printer language. Notes: <ul style="list-style-type: none"> • On is the factory default setting. • When set to Off, the printer does not examine incoming data. The printer uses PCL emulation if PCL SmartSwitch is set to On. It uses the default printer language specified in the Setup menu if PCL SmartSwitch is set to Off.
NPA Mode On Off Auto	Set the printer to perform the special processing required for bidirectional communication following the conventions defined by the NPA protocol. Notes: <ul style="list-style-type: none"> • Auto is the factory default setting. Auto sets the printer to examine data, determine the format, and then processes it appropriately. • When set to On, the printer performs NPA processing. If the data is not in NPA format, it is rejected as bad data. • When set to Off, the printer does not perform NPA processing. • Changing this setting from the printer control panel and then exiting the menus causes the printer to restart. The menu selection is then updated.

Use	To
<p>Serial Buffer</p> <p>Disabled Auto 3K to [maximum size allowed]</p>	<p>Set the size of the serial input buffer.</p> <p>Notes:</p> <ul style="list-style-type: none"> • Auto is the factory default setting. • Disabled turns off job buffering. Any jobs already buffered on the disk are printed before normal processing is resumed. • The serial buffer size setting can be changed in 1-KB increments. • The maximum size allowed depends on the amount of memory in the printer, the size of the other link buffers, and whether Resource Save is set to On or Off. • To increase the maximum size range for the Serial Buffer, disable or reduce the size of the parallel, serial, and network buffers. • Changing this setting from the printer control panel and then exiting the menus causes the printer to restart. The menu selection is then updated.
<p>Job Buffering</p> <p>Off On Auto</p>	<p>Temporarily store print jobs on the printer hard disk before printing.</p> <p>Notes:</p> <ul style="list-style-type: none"> • Off is the factory default setting. The printer does not buffer print jobs on the printer hard disk. • On buffers print jobs on the printer hard disk. • Auto buffers print jobs only if the printer is busy processing data from another input port. • Changing this setting from the printer control panel and then exiting the menus causes the printer to restart. The menu selection is then updated.
<p>Protocol</p> <p>DTR DTR/DSR XON/XOFF XON/XOFF/DTR XONXOFF/DTRDSR</p>	<p>Select the hardware and software handshaking settings for the serial port.</p> <p>Notes:</p> <ul style="list-style-type: none"> • DTR is the factory default setting. • DTR/DSR is a hardware handshaking setting. • XON/XOFF is a software handshaking setting. • XON/XOFF/DTR and XON/XOFF/DTR/DSR are combined hardware and software handshaking settings.
<p>Robust XON</p> <p>On Off</p>	<p>Determine whether the printer communicates availability to the computer.</p> <p>Notes:</p> <ul style="list-style-type: none"> • Off is the factory default setting. • This menu item applies only to the serial port if Serial Protocol is set to XON/XOFF.

Use	To
Baud 1200 2400 4800 9600 19200 38400 57600 115200 138200 172800 230400 345600	Specify the rate at which data can be received through the serial port. Notes: <ul style="list-style-type: none"> • 9600 is the factory default setting. • 138200, 172800, 230400, and 345600 baud rates are only displayed in the Standard Serial menu. These settings do not appear in the Serial Option 1, Serial Option 2, or Serial Option 3 menus.
Data Bits 7 8	Specify the number of data bits sent in each transmission frame. Note: 8 is the factory default setting.
Parity Even Odd None Ignore	Set the parity for serial input and output data frames. Note: None is the factory default setting.
Honor DSR On Off	Determine whether the printer uses the DSR Signal. Notes: <ul style="list-style-type: none"> • Off is the factory default setting. • DSR is a handshaking signal used by most serial cables. The serial port uses DSR to distinguish data sent by the computer from data created by electrical noise in the serial cable. The electrical noise can cause stray characters to print. Set this to On to prevent stray characters from printing.

SMTP Setup menu

Use	To
Primary SMTP Gateway	Specify SMTP server gateway and port information. Note: 25 is the default SMTP gateway port.
Primary SMTP Gateway Port	
Secondary SMTP Gateway	
Secondary SMTP Gateway Port	
SMTP Timeout 5–30	Specify the amount of time in seconds before the server stops trying to send an e-mail. Note: 30 seconds is the factory default setting.
Reply Address	Specify a reply address of up to 128 characters in the e-mail sent by the printer.

Use	To
Use SSL Disabled Negotiate Required	Set the printer to use SSL for increased security when connecting to the SMTP server. Notes: <ul style="list-style-type: none"> • Disabled is the factory default setting. • When the Negotiate setting is used, the SMTP server determines if SSL will be used.
SMTP Server Authentication No authentication required Login/Plain CRAM-MD5 Digest-MD5 NTLM Kerberos 5	Specify the type of user authentication required for scan-to e-mail privileges. Note: “No authentication required” is the factory default setting.
Device-Initiated E-mail None Use Device SMTP Credentials	Specify what credentials will be used when communicating to the SMTP server. Some SMTP servers require credentials to send an e-mail. Notes: <ul style="list-style-type: none"> • None is the factory default setting for Device-Initiated E-mail and User-Initiated E-mail. • Device Userid and Device Password are used to log in to the SMTP server when Use Device SMTP Credentials is selected.
User-Initiated E-mail* None Use Device SMTP Credentials Use Session User ID & Password Use Session E-mail address & Password Prompt User	
Device Userid	
Device Password	
Kerberos 5 Realm	
NTLM Domain	

Security menu

Edit Security Setups menu

Use	To
Edit Backup Password Use Backup Password Off On Password	Create a backup password. Notes: <ul style="list-style-type: none"> • Off is the factory default setting for Use Backup Password. • This menu item appears only if a backup password exists.

Use	To
Edit Building Blocks Internal Accounts NTLM Simple Kerberos Setup Kerberos Setup Active Directory LDAP LDAP+GSSAPI Password PIN	Edit settings for Internal Accounts, NTLM, Simple Kerberos Setup, Kerberos Setup, Active Directory, LDAP, Password, and PIN.
Edit Security Templates [list of available templates]	Add or edit a security template.
Edit Access Controls Administrative Menus Function Access Apps Configuration Management Solutions Cancel jobs at the Device	Control access to printer menus, firmware updates, held jobs, and other access points.

Miscellaneous Security Settings menu

Use	To
Login Restrictions Login failures Failure time frame Lockout time Panel Login Timeout Remote Login Timeout	Limit the number and time frames of failed login attempts from the printer control panel before <i>all</i> users are locked out. Notes: <ul style="list-style-type: none"> • “Login failures” specifies the number of failed login attempts before users are locked out. You can choose from 1 to 10 attempts. The factory default setting is 3. • “Failure time frame” specifies the time frame during which failed login attempts can be made before users are locked out. You can choose from 1 to 60 minutes. The factory default setting is 5 minutes. • “Lockout time” specifies how long users are locked out after exceeding the login failures limit. You can choose from 1 to 60 minutes. The factory default setting is 5 minutes. The printer does not impose a lockout time if you set to 1 minute. • Panel Login Timeout specifies how long the printer remains idle on the home screen before automatically logging the user off. You can choose from 1 to 900 seconds. The factory default setting is 30 seconds. • Remote Login Timeout specifies how long a remote interface remains idle before automatically logging the user off. You can choose from 1 to 120 minutes. The factory default setting is 10 minutes.
Minimum PIN Length 1–16	Limit the digit length of the PIN. Note: 4 is the factory default setting.

Confidential Print menu

Use	To
Max Invalid PIN Off 2–10	Set a limit on the number of times an invalid PIN can be entered. Notes: <ul style="list-style-type: none"> • This menu item appears only when a formatted, working printer hard disk is installed. • When the limit is reached, the print jobs for that user name and PIN are deleted.
Confidential Job Expiration Off 1 hour 4 hours 24 hours 1 week	Set a limit on how long the printer stores confidential print jobs. Notes: <ul style="list-style-type: none"> • If the “Confidential Job Expiration” setting is changed while confidential print jobs reside in the printer memory or printer hard disk, then the expiration time for those print jobs does not change to the new default value. • If the printer is turned off, then all confidential jobs held in the printer memory are deleted.
Repeat Job Expiration Off 1 hour 4 hours 24 hours 1 week	Set a limit on how long the printer stores print jobs.
Verify Job Expiration Off 1 hour 4 hours 24 hours 1 week	Set a limit on how long the printer stores print jobs needing verification.
Reserve Job Expiration Off 1 hour 4 hours 24 hours 1 week	Set a limit on how long the printer stores print jobs for printing at a later time.
Note: Off is the factory default setting.	

Erase Temporary Data Files menu

Erase Temporary Data Files deletes *only* print job data on the printer hard disk that *are not* currently in use by the file system. All permanent data on the printer hard disk are preserved, such as downloaded fonts, macros, and held jobs.

Note: This menu appears only when a formatted, working printer hard disk is installed.

Use	To
Wiping Mode Auto	Specify the mode for erasing temporary data files.
Automatic Method Single pass Multiple pass	Mark all disk space used by a previous print job. This method does not permit the file system to reuse this space until it has been cleared. Notes: <ul style="list-style-type: none"> • “Single pass” is the factory default setting. • Only automatic wiping enables users to erase temporary data files without having to turn off the printer for an extended amount of time. • Highly confidential information should be erased using <i>only</i> the Multiple pass method.

Security Audit Log menu

Use	To
Export Log	Let an authorized user export the audit log. Notes: <ul style="list-style-type: none"> • To export the audit log from the printer control panel, a flash drive must be attached to the printer. • The audit log can be downloaded from the Embedded Web Server and saved on a computer.
Delete Log Yes No	Specify whether or not audit logs are deleted. Note: Yes is the factory default setting.
Configure Log Enable Audit Yes No Enable Remote Syslog No Yes Remote Syslog Facility 0–23 Severity of events to log 0–7	Specify how and whether or not audit logs are created. Notes: <ul style="list-style-type: none"> • Enable Audit determines if events are recorded in the secure audit log and remote syslog. No is the factory default setting. • Enable Remote Syslog determines if logs are sent to a remote server. No is the factory default setting. • Remote Syslog Facility determines the value used to send logs to the remote syslog server. 4 is the factory default setting. • If the security audit log is activated, then the severity value of each event is recorded. 4 is the factory default setting.

Set Date and Time menu

Use	To
Current Date and Time	Show the current date and time settings for the printer.

Use	To
<p>Manually Set Date and Time [input date/time]</p>	<p>Enter the date and time.</p> <p>Notes:</p> <ul style="list-style-type: none"> • Manually setting the date and time sets Enable NTP to No. • The wizard lets you set the date and time in YYYY-MM-DD-HH:MM format.
<p>Time Zone [list of time zones]</p>	<p>Select the time zone.</p> <p>Note: GMT is the factory default setting.</p>
<p>Automatically observe DST On Off</p>	<p>Set the printer to use the applicable daylight saving time (DST) start and end times associated with the printer Time Zone setting.</p> <p>Note: On is the factory default setting.</p>
<p>Enable NTP On Off</p>	<p>Enable Network Time Protocol, which synchronizes the clocks of devices on a network.</p> <p>Notes:</p> <ul style="list-style-type: none"> • On is the factory default setting. • The setting is turned off if you manually set the date and time.

Settings menu

General Settings

General Settings menu

Use	To
<p>Display Language</p> <ul style="list-style-type: none"> English Francais Deutsch Italiano Espanol Dansk Norsk Nederlands Svenska Portuguese Suomi Russian Polski Greek Magyar Turkce Cesky Simplified Chinese Traditional Chinese Korean Japanese 	<p>Set the language of the text that appears on the printer display.</p> <p>Note: Not all languages are available for all printers, and you may need to install special hardware for those languages to appear.</p>
<p>Eco-Mode</p> <ul style="list-style-type: none"> Off Energy Energy/Paper Paper 	<p>Minimize the use of energy, paper, or specialty media.</p> <p>Notes:</p> <ul style="list-style-type: none"> • Off is the factory default setting. This resets the printer to its factory default settings. • Energy minimizes the power used by the printer. Performance may be affected, but print quality is not. • Energy/Paper minimizes the use of power and paper specialty media. • Paper minimizes the amount of paper and specialty media needed for a print job. Performance may be affected, but print quality is not.

Use	To
<p>Quiet Mode</p> <ul style="list-style-type: none"> Off On 	<p>Reduce the amount of noise produced by the printer.</p> <p>Notes:</p> <ul style="list-style-type: none"> • Off is the factory default setting. This supports the performance specifications for your printer. • On configures the printer to produce as little noise as possible. This is best suited for printing text and line art. • For optimal printing of color-rich documents, set Quiet Mode to Off. • Selecting Photo from the print driver may disable Quiet Mode and provide better print quality and full speed printing.
<p>Run Initial setup</p> <ul style="list-style-type: none"> Yes No 	<p>Set the printer to run the setup wizard.</p> <p>Note: Yes is the factory default setting. After completing the setup wizard, the default becomes No.</p>
<p>Keyboard</p> <ul style="list-style-type: none"> Keyboard Type English Francais Francais Canadien Deutsch Italiano Espanol Greek Dansk Norsk Nederlands Svenska Suomi Portuguese Russian Polski Swiss German Swiss French Korean Magyar Turkce Cesky Simplified Chinese Traditional Chinese Japanese Custom Key [x] 	<p>Specify a language and custom key information for the printer keyboard. The additional tabs enable access to accent marks and symbols from the keyboard.</p>

Use	To
<p>Paper Sizes US Metric</p>	<p>Specify the default paper measurement.</p> <p>Notes:</p> <ul style="list-style-type: none"> • US is the factory default setting. • The initial setting is determined by your country or region selection in the initial setup wizard. • Changing this also changes the default setting for each input source in the Paper Size/Type menu.
<p>Displayed Information Left side Right side Custom Text [x]</p>	<p>Specify what is displayed on the upper left and right corners of the home screen.</p> <p>For the Left side and Right side menus, select from the following options:</p> <ul style="list-style-type: none"> None IP Address Hostname Contact Name Location Date/Time mDNS/DDNS Service Name Zero Configuration Name Custom Text [x] Model Name <p>Notes:</p> <ul style="list-style-type: none"> • IP Address is the factory default setting for Left side. • Date/Time is the factory default setting for Right side.
<p>Displayed Information (continued) Black Toner</p>	<p>Customize the displayed information for Black Toner.</p> <p>Select from the following options:</p> <ul style="list-style-type: none"> When to display <ul style="list-style-type: none"> Do not display Display Message to Display <ul style="list-style-type: none"> Default Alternate Default <ul style="list-style-type: none"> [text entry] Alternate <ul style="list-style-type: none"> [text entry] <p>Notes:</p> <ul style="list-style-type: none"> • Do not display is the factory default setting for When to display. • Default is the factory default setting for Message to Display.

Use	To
<p>Displayed Information (continued)</p> <ul style="list-style-type: none"> Waste Toner Bottle Paper Jam Load Paper Service Errors 	<p>Customize the displayed information for Waste Toner Bottle, Paper Jam, Load Paper, and Service Errors.</p> <p>Select from the following options:</p> <ul style="list-style-type: none"> Display <ul style="list-style-type: none"> Yes No Message to display <ul style="list-style-type: none"> Default Alternate Default <ul style="list-style-type: none"> [text entry] Alternate <ul style="list-style-type: none"> [text entry] <p>Notes:</p> <ul style="list-style-type: none"> • No is the factory default setting for Display. • Default is the factory default setting for Message to Display.
<p>Home screen customization</p> <ul style="list-style-type: none"> Change Language Search Held Jobs Held Jobs USB Drive Profiles and Apps Bookmarks Jobs by user Forms and Favorites Background and Idle Screen Eco-Settings 	<p>Change the icons and buttons that appear on the control panel.</p> <p>For each icon or button, select from the following options:</p> <ul style="list-style-type: none"> Display Do not display <p>Notes:</p> <ul style="list-style-type: none"> • Display is the factory default setting for Search Held Jobs, Held Jobs, USB Drive, Forms and Favorites, Background and Idle Screen, and Eco-Settings. • Do not display is the factory default setting for Change Language, Profiles and Apps, Bookmarks, and Jobs by user.
<p>Date Format</p> <ul style="list-style-type: none"> MM-DD-YYYY DD-MM-YYYY YYYY-MM-DD 	<p>Format the printer date.</p> <p>Notes:</p> <ul style="list-style-type: none"> • MM-DD-YYYY is the U.S. factory default setting. • DD-MM-YYYY is the international factory default setting.
<p>Time Format</p> <ul style="list-style-type: none"> 12 hour A.M./P.M. 24 hour clock 	<p>Format the printer time.</p> <p>Note: 12 hour A.M./P.M. is the factory default setting.</p>
<p>Screen Brightness</p> <ul style="list-style-type: none"> 20–100 	<p>Specify the brightness of the control panel screen.</p> <p>Note: 100 is the factory default setting.</p>

Use	To
<p>Audio Feedback</p> <p>Button Feedback</p> <p> On</p> <p> Off</p> <p>Volume</p> <p> 1–10</p>	<p>Set the audio volume for the buttons.</p> <p>Notes:</p> <ul style="list-style-type: none"> • On is the factory default setting for Button Feedback. • 5 is the factory default setting for Volume.
<p>Show Bookmarks</p> <p>Yes</p> <p>No</p>	<p>Specify whether bookmarks are displayed from the Held Jobs area.</p> <p>Note: Yes is the factory default setting.</p>
<p>Web Page Refresh Rate</p> <p>30–300</p>	<p>Specify the number of seconds between Embedded Web Server refreshes.</p> <p>Note: 120 is the factory default setting.</p>
<p>Contact Name</p>	<p>Specify a contact name for the printer.</p> <p>Note: The contact name is stored on the Embedded Web Server.</p>
<p>Location</p>	<p>Specify the location of the printer.</p> <p>Note: The location is stored on the Embedded Web Server.</p>
<p>Alarms</p> <p>Alarm Control</p> <p>Cartridge Alarm</p> <p>Staple Alarm</p> <p>Hole Punch Alarm</p>	<p>Set an alarm when the printer requires user intervention.</p> <p>For each alarm type, select from the following options:</p> <p> Off</p> <p> Single</p> <p> Continuous</p> <p>Notes:</p> <ul style="list-style-type: none"> • Off is the factory default setting for Cartridge Alarm, Staple Alarm, and Hole Punch Alarm. • Single is the factory default setting for Alarm Control. This sounds three quick beeps. • Continuous repeats three beeps every 10 seconds.
<p>Timeouts</p> <p>Standby Mode</p> <p> Disabled</p> <p> 1–240</p>	<p>Specify the number of minutes of inactivity before the printer enters a lower power state.</p> <p>Note: 15 is the factory default setting.</p>

Use	To
<p>Timeouts</p> <p>Sleep Mode</p> <p>Disabled</p> <p>1–120</p>	<p>Set the amount of time in minutes the printer waits after a job is printed before it goes into a reduced power state.</p> <p>Notes:</p> <ul style="list-style-type: none"> • 20 is the factory default setting. • Disabled appears only when Energy Conserve is set to Off. • Lower settings conserve more energy, but may require longer warm-up times. • Select a high setting if the printer is in constant use. Under most circumstances, this keeps the printer ready to print with minimum warm-up time.
<p>Timeouts</p> <p>Print with Display off</p> <p>Allow printing with display off</p> <p>Display on when printing</p>	<p>Allow the printer to print even when the display is off.</p> <p>Note: Allow printing with display off is the factory default setting.</p>
<p>Timeouts</p> <p>Hibernate Timeout</p> <p>Disabled</p> <p>1 hour</p> <p>2 hours</p> <p>3 hours</p> <p>6 hours</p> <p>1 day</p> <p>2 days</p> <p>3 days</p> <p>1 week</p> <p>2 weeks</p> <p>1 month</p>	<p>Set the amount of time before the printer enters Hibernate mode.</p> <p>Note: 3 days is the factory default setting.</p>
<p>Timeouts</p> <p>Hibernate Timeout on Connection</p> <p>Do Not Hibernate</p> <p>Hibernate</p>	<p>Set the printer to Hibernate Timeout even when there is an active Ethernet connection.</p> <p>Note: Hibernate is the factory default setting.</p>
<p>Timeouts</p> <p>Screen Timeout</p> <p>15–300 sec</p>	<p>Set the amount of time in seconds the printer waits before returning to Ready state.</p> <p>Note: 30 sec is the factory default setting.</p>
<p>Timeouts</p> <p>Prolong Screen Timeout</p> <p>On</p> <p>Off</p>	<p>Set the printer to continue a specified job without returning to the home screen when the screen timeout timer expires.</p> <p>Note: Off is the factory default setting.</p>

Use	To
<p>Timeouts</p> <p>Print Timeout</p> <p>Disabled</p> <p>1–255 sec</p>	<p>Set the amount of time in seconds the printer waits to receive an end-of-job message before canceling the rest of the print job.</p> <p>Notes:</p> <ul style="list-style-type: none"> • 90 sec is the factory default setting. • When the timer expires, any partially printed page still in the printer is printed, and then the printer checks to see if any new print jobs are waiting. • Print Timeout is available only when using PCL emulation. This setting has no effect on PostScript emulation print jobs.
<p>Timeouts</p> <p>Wait Timeout</p> <p>Disabled</p> <p>15–65535 sec</p>	<p>Set the amount of time in seconds the printer waits for additional data before canceling a print job.</p> <p>Notes:</p> <ul style="list-style-type: none"> • 40 sec is the factory default setting. • Wait Timeout is available only when the printer is using PostScript emulation. This setting has no effect on PCL emulation print jobs.
<p>Timeouts</p> <p>Job Hold Timeout</p> <p>5–255 sec</p>	<p>Set the amount of time the printer waits for user intervention before it holds jobs that require unavailable resources and continues to print other jobs in the print queue.</p> <p>Notes:</p> <ul style="list-style-type: none"> • 30 sec is the factory default setting. • This menu appears only when a formatted printer hard disk is installed.
<p>Error Recovery</p> <p>Auto Reboot</p> <p>Reboot when idle</p> <p>Reboot always</p> <p>Reboot never</p>	<p>Set the printer to restart when an error is encountered.</p> <p>Note: Reboot always is the factory default setting.</p>
<p>Error Recovery</p> <p>Max Auto Reboots</p> <p>1–20</p>	<p>Determine the number of automatic reboots the printer can perform.</p> <p>Note: 2 is the factory default setting.</p>
<p>Print Recovery</p> <p>Auto Continue</p> <p>Disabled</p> <p>5–255</p>	<p>Let the printer automatically continue printing from certain offline situations when not resolved within the specified time period.</p> <p>Note: Disabled is the factory default setting.</p>

Use	To
<p>Print Recovery</p> <p>Jam Recovery</p> <ul style="list-style-type: none"> On Off Auto 	<p>Specify whether the printer reprints jammed pages.</p> <p>Notes:</p> <ul style="list-style-type: none"> • Auto is the factory default setting. The printer reprints jammed pages unless the memory required to hold the pages is needed for other printer tasks. • On sets the printer to always reprint jammed pages. • Off sets the printer to never reprint jammed pages.
<p>Print Recovery</p> <p>Jam Assist</p> <ul style="list-style-type: none"> On Off 	<p>Set the printer to automatically check for jammed paper.</p> <p>Note: On is the factory default setting.</p>
<p>Print Recovery</p> <p>Page Protect</p> <ul style="list-style-type: none"> Off On 	<p>Let the printer successfully print a page that may not have printed otherwise.</p> <p>Notes:</p> <ul style="list-style-type: none"> • Off is the factory default setting. This prints a partial page when there is not enough memory to print the whole page. • On sets the printer to process the whole page so that the entire page prints.
<p>Press Sleep Button</p> <ul style="list-style-type: none"> Do nothing Sleep Hibernate 	<p>Determine how the printer responds when pressing the Sleep button while the printer is idle.</p> <p>Notes:</p> <ul style="list-style-type: none"> • Sleep is the factory default setting. • Sleep or Hibernate sets the printer to operate at a lower power configuration. • If the printer is in Sleep mode, then the display appears off and the Sleep button turns amber. Touch anywhere on the display or press a button on the control panel to wake the printer from Sleep mode. • If the printer is in Hibernate mode, then the display is completely off and the Sleep button turns amber and is blinking.
<p>Press and Hold Sleep Button</p> <ul style="list-style-type: none"> Do nothing Sleep Hibernate 	<p>Determine how the printer responds when pressing the Sleep button for 3 seconds or longer while the printer is idle.</p> <p>Notes:</p> <ul style="list-style-type: none"> • Do Nothing is the factory default setting. • Sleep or Hibernate sets the printer to operate at a lower power configuration. • If the printer is in Sleep mode, then the display appears off and the Sleep button turns amber. Touch anywhere on the display or press a button on the control panel to wake the printer from Sleep mode.

Use	To
Factory Defaults Do Not Restore Restore Now	Restore the printer settings to the factory default settings. Notes: <ul style="list-style-type: none"> • Do Not Restore is the factory default setting. This keeps the user-defined settings. • Restore Now returns all printer settings to the factory default settings except Network/Ports menu settings. All downloads stored in RAM are deleted. Downloads stored in flash memory or on a printer hard disk are not affected.
Export Configuration Package Export	Export the printer configuration file to a flash drive.

Flash Drive

Print Settings menu

Use	To
Copies 1–999	Specify a default number of copies for each print job. Note: 1 is the factory default setting.
Paper Source Tray [x] MP Feeder Manual Paper	Set a default paper source for all print jobs. Note: Tray 1 is the factory default setting.
Collate (1,1) (2,2) (1,2,3) (1,2,3)	Stack the pages of a print job in sequence when printing multiple copies. Note: “(1,2,3) (1,2,3)” is the factory default setting.
Sides (Duplex) 1 sided 2 sided	Specify whether prints are on one side or on both sides of the page. Note: 1 sided is the factory default setting.
Staple Off On	Specify whether prints are stapled. Notes: <ul style="list-style-type: none"> • Off is the factory default setting. • On allows the printer to staple print jobs. • This menu appears only when a supported staple finisher is installed.
Hole Punch Off On	Specify whether prints have holes for binding. Notes: <ul style="list-style-type: none"> • Off is the factory default setting. • This menu appears only when a supported staple, hole punch finisher is installed.

Use	To
Hole Punch Mode 2 holes 3 holes 4 holes	Specify the number of holes to be made on the prints. Notes: <ul style="list-style-type: none"> • “3 holes” is the U.S. factory default setting. “4 holes” is the international factory default setting. • This menu appears only when a supported staple, hole punch finisher is installed.
Duplex Binding Long Edge Short Edge	Define the way duplexed pages are bound and printed. Notes: <ul style="list-style-type: none"> • Long Edge assumes binding along the long edge of the page (left edge for portrait and top edge for landscape). This is the factory default setting. • Short Edge assumes binding along the short edge of the page (top edge for portrait and left edge for landscape).
Paper Saver Orientation Auto Landscape Portrait	Specify the orientation of a multiple-page document. Notes: <ul style="list-style-type: none"> • Auto is the factory default setting. • This setting affects jobs if the value of the Paper Saver setting in the same menu is not set to Off.
Paper Saver Off 2-Up 3-Up 4-Up 6-Up 9-Up 12-Up 16-Up	Specify that multiple-page images be printed on one side of a paper. Notes: <ul style="list-style-type: none"> • Off is the factory default setting. • The number selected is the number of page images that will print per side.
Paper Saver Border None Solid	Print a border on each page image when using N-Up (pages per side). Notes: <ul style="list-style-type: none"> • None is the factory default setting. • This setting affects jobs if the value of the Paper Saver setting in the same menu is not set to Off.
Paper Saver Ordering Horizontal Reverse Horizontal Reverse Vertical Vertical	Specify the positioning of multiple-page images when using N-Up (pages per side). Notes: <ul style="list-style-type: none"> • Horizontal is the factory default setting. • Positioning depends on the number of page images and whether they are in portrait or landscape orientation. • This setting affects jobs if the value of the Paper Saver setting in the same menu is not set to Off.

Use	To
<p>Separator Sheets Off Between Copies Between Jobs Between Pages</p>	<p>Specify if blank separator sheets are inserted.</p> <p>Notes:</p> <ul style="list-style-type: none"> • Off is the factory default setting. • Between Copies inserts a blank sheet between each copy of a print job if Collate is set to “(1,2,3) (1,2,3).” If Collate is set to “(1,1,1) (2,2,2),” then a blank page is inserted between each set of printed pages, such as after all page 1's and after all page 2's. • Between Jobs inserts a blank sheet between print jobs. • Between Pages inserts a blank sheet between each page of the print job. This setting is useful when printing on transparencies or when inserting blank pages in a document for notes.
<p>Separator Sheet Source Tray [x] Manual Feeder MP Feeder</p>	<p>Specify the paper source for the separator sheet.</p> <p>Note: Tray 1 is the factory default setting.</p>
<p>Blank Pages Do Not Print Print</p>	<p>Specify if blank pages are inserted in a print job.</p> <p>Note: Do Not Print is the factory default setting.</p>

Print Settings

Setup menu

Use	To
<p>Printer Language PCL Emulation PS Emulation</p>	<p>Set the default printer language.</p> <p>Notes:</p> <ul style="list-style-type: none"> • PCL Emulation is the factory default setting. • PostScript emulation uses a PostScript interpreter for processing print jobs. • PCL Emulation uses a PCL interpreter for processing print jobs. • Setting a printer language default does not prevent a software program from sending print jobs that use another printer language.

Use	To
<p>Job Waiting</p> <p>On Off</p>	<p>Determine if print jobs are removed from the print queue when they require unavailable printer options or custom settings. These print jobs are stored in a separate print queue, so other jobs print normally. When the missing information or options, or both are obtained, the stored jobs print.</p> <p>Notes:</p> <ul style="list-style-type: none"> • Off is the factory default setting. • This menu appears only if a non-read-only printer hard disk is installed. This requirement ensures that stored jobs are not deleted if the printer loses power.
<p>Print Area</p> <p>Normal Whole Page</p>	<p>Set the logical and physical printable area.</p> <p>Notes:</p> <ul style="list-style-type: none"> • Normal is the factory default setting. When attempting to print data in the non-printable area defined by the Normal setting, the printer clips the image at the boundary. • Whole Page allows the image to be moved into the non-printable area defined by the Normal setting, but the printer clips the image at the Normal setting boundary. This setting affects only pages printed using a PCL 5e interpreter and has no effect on pages printed using the PCL XL or PostScript interpreter.
<p>Download Target</p> <p>RAM Flash Disk</p>	<p>Set the storage location for downloads.</p> <p>Notes:</p> <ul style="list-style-type: none"> • RAM is the factory default setting. Storing downloads in the RAM is temporary. • Storing downloads in a flash memory or in a printer hard disk places them in permanent storage. Downloads remain in the flash memory or printer hard disk even when the printer is turned off. • This menu item appears only if an optional flash memory or printer hard disk is installed.
<p>Resource Save</p> <p>On Off</p>	<p>Specify how the printer handles temporary downloads, such as fonts and macros stored in the RAM, when the printer receives a print job that requires more than the available memory.</p> <p>Notes:</p> <ul style="list-style-type: none"> • Off is the factory default setting. Off sets the printer to retain downloads only until memory is needed. Downloads are deleted in order to process print jobs. • On sets the printer to retain downloads during language changes and printer resets. If the printer runs out of memory, then Memory Full [38] appears on the printer display, but downloads are not deleted.

Use	To
Print All Order Alphabetical Oldest First Newest First	Specify the order in which held and confidential jobs are printed when Print All is selected. Note: Alphabetical is the factory default setting

Finishing menu

Use	To
Sides (Duplex) 1 sided 2 sided	Specify whether two-sided printing is set as the default for all print jobs. Notes: <ul style="list-style-type: none"> • 1 sided is the factory default setting. • You can set two-sided printing from the printer software.
Duplex Binding Long Edge Short Edge	Define the way two-sided pages are bound and printed. Notes: <ul style="list-style-type: none"> • Long Edge is the factory default setting. This setting assumes binding along the long edge of the page (left edge for portrait and top edge for landscape). • Short Edge assumes binding along the short edge of the page (top edge for portrait and left edge for landscape).
Copies 1–999	Specify the default number of copies for each print job. Note: 1 is the factory default setting.
Blank Pages Do Not Print Print	Specify whether blank pages are inserted in a print job. Note: Do Not Print is the factory default setting.
Collate (1,1,1) (2,2,2) (1,2,3) (1,2,3)	Stack the pages of a print job in sequence when printing multiple copies. Note: (1,1,1) (2,2,2) is the factory default setting.
Separator Sheets Off Between Copies Between Jobs Between Pages	Specify whether blank separator sheets are inserted. Notes: <ul style="list-style-type: none"> • Off is the factory default setting. • Between Copies inserts a blank sheet between each copy of a print job if Collate is set to (1,2,3) (1,2,3). If Collate is set to (1,1,1) (2,2,2), then a blank page is inserted between each set of printed pages, such as after all page 1's and after all page 2's. • Between Jobs inserts a blank sheet between print jobs. • Between Pages inserts a blank sheet between each page of a print job. This setting is useful when printing transparencies or when inserting blank pages in a document.

Use	To
<p>Separator Source Tray [x] Multipurpose Feeder</p>	<p>Specify the paper source for the separator sheet.</p> <p>Notes:</p> <ul style="list-style-type: none"> • Tray 1 (standard tray) is the factory default setting. • From the Paper menu, set Configure MP to "Cassette" for Multipurpose Feeder to appear as a menu setting.
<p>Paper Saver Off 2-Up 3-Up 4-Up 6-Up 9-Up 12-Up 16-Up</p>	<p>Print multiple-page images on one side of a paper.</p> <p>Notes:</p> <ul style="list-style-type: none"> • Off is the factory default setting. • The number selected is the number of page images that are printed per side.
<p>Paper Saver Ordering Horizontal Reverse Horizontal Reverse Vertical Vertical</p>	<p>Specify the positioning of multiple-page images when using Paper Saver.</p> <p>Notes:</p> <ul style="list-style-type: none"> • Horizontal is the factory default setting. • Positioning depends on the number of page images and whether they are in portrait or landscape orientation.
<p>Paper Saver Orientation Auto Landscape Portrait</p>	<p>Specify the orientation of a multiple-page document.</p> <p>Note: Auto is the factory default setting. The printer chooses between portrait and landscape.</p>
<p>Paper Saver Border None Solid</p>	<p>Print a border when using Paper Saver.</p> <p>Note: None is the factory default setting.</p>
<p>Staple Job Auto Back Dual Front Off</p>	<p>Specify whether printed output is stapled.</p> <p>Notes:</p> <ul style="list-style-type: none"> • Off is the factory default setting. • This menu appears only when a supported staple finisher is installed.
<p>Run Stapler Test</p>	<p>Print a report that confirms that the staple finisher is functioning properly.</p> <p>Note: This menu appears only when a supported staple finisher is installed.</p>
<p>Hole Punch On Off</p>	<p>Specify whether holes are created on printed outputs for the purpose of collecting the sheets in a binder or folder.</p> <p>Notes:</p> <ul style="list-style-type: none"> • Off is the factory default setting. • This menu appears only when a supported staple, hole punch finisher is installed.

Use	To
<p>Hole Punch Mode</p> <ul style="list-style-type: none"> 2 holes 3 holes 4 holes 	<p>Specify the number of holes to be created on printed outputs for the purpose of collecting the sheets in a binder or folder.</p> <p>Note: This menu appears only when a supported staple, hole punch finisher is installed.</p>
<p>Offset Pages</p> <ul style="list-style-type: none"> None Between Copies Between Jobs 	<p>Offset pages at certain instances.</p> <p>Notes:</p> <ul style="list-style-type: none"> • None is the factory default setting. • Between Copies inserts a blank sheet between each copy of a print job if Collate is set to (1,2,3) (1,2,3). If Collate is set to (1,1,1) (2,2,2), then a blank page is inserted between each set of printed pages, such as after all page 1's and after all page 2's. • Between Jobs sets the same offset position for the entire print job regardless of the number of copies printed. • This menu appears only when a supported staple finisher is installed.

Quality menu

Use	To
<p>Print Resolution</p> <ul style="list-style-type: none"> 300 dpi 600 dpi 1200 dpi 1200 Image Q 2400 Image Q 	<p>Specify the printed output resolution in dots per inch (dpi) or image quality.</p> <p>Note: 600 dpi is the factory default setting.</p>
<p>Pixel Boost</p> <ul style="list-style-type: none"> Off Fonts Horizontally Vertically Both directions 	<p>Enable more pixels to clarify and enhance images or text.</p> <p>Note: Off is the factory default setting.</p>
<p>Toner Darkness</p> <ul style="list-style-type: none"> 1–10 	<p>Determine the darkness of the printed output.</p> <p>Notes:</p> <ul style="list-style-type: none"> • 8 is the factory default setting. • Selecting a smaller number can help conserve toner.

Use	To
Enhance Fine Lines On Off	Enhance the printed output to have smoother lines with sharper edges. Notes: <ul style="list-style-type: none"> • Off is the factory default setting. • You can set this option from the printer software. For Windows users, click File > Print, and then click Properties or Preferences. For Macintosh users, choose File > Print, and then adjust the settings from the Print dialog and context menus. • To set this option using the Embedded Web Server, type the network printer IP address in the Web browser address field.
Gray Correction Auto Off	Adjust the contrast enhancement applied to images. Note: Auto is the factory default setting.
Brightness -6 to 6	Lighten or darken the printed output. Note: 0 is the factory default setting.
Contrast 0–5	Adjust the contrast of printed objects. Note: 0 is the factory default setting.

Job Accounting menu

Note: This menu item appears only when a formatted, working printer hard disk is installed.

Use	To
Job Accounting Log Off On	Determine and set if the printer creates a log of the print jobs it receives. Note: Off is the factory default setting.
Job Accounting Utilities	Print and delete log files or export them to a flash drive.
Accounting Log Frequency Daily Weekly Monthly	Determine and set how often a log file is created. Note: Monthly is the factory default setting.
Log Action at End of Frequency None E-mail Current Log E-mail & Delete Current Log Post Current Log Post & Delete Current Log	Determine and set how the printer responds when the frequency threshold expires. Note: None is the factory default setting.
Log Near Full Level Off 1–99	Specify the maximum size of the log file before the printer executes the Log Action at Near Full. Note: 5 is the factory default setting.

Use	To
<p>Log Action at Near Full</p> <ul style="list-style-type: none"> None E-mail Current Log E-mail & Delete Current Log E-mail & Delete Oldest Log Post Current Log Post & Delete Current Log Post & Delete Oldest Log Delete Current Log Delete Oldest Log Delete All Logs Delete All But Current 	<p>Determine and set how the printer responds when the hard disk is nearly full.</p> <p>Notes:</p> <ul style="list-style-type: none"> • None is the factory default setting. • The value defined in Log Near Full Level determines when this action is triggered.
<p>Log Action at Full</p> <ul style="list-style-type: none"> None E-mail & Delete Current Log E-mail & Delete Oldest Log Post & Delete Current Log Post & Delete Oldest Log Delete Current Log Delete Oldest Log Delete All Logs Delete All But Current 	<p>Determine and set how the printer responds when disk usage reaches the maximum limit (100MB).</p> <p>Note: None is the factory default setting.</p>
<p>URL to Post Logs</p>	<p>Determine and set where the printer posts job accounting logs.</p>
<p>E-mail Address to Send Logs</p>	<p>Specify the e-mail address to which the printer sends job accounting logs.</p>
<p>Log File Prefix</p>	<p>Specify the prefix you want for the log file name.</p> <p>Note: The current host name defined in the TCP/IP menu is used as the default log file prefix.</p>

Utilities menu

Use	To
<p>Remove Held Jobs</p> <ul style="list-style-type: none"> Confidential Held Not Restored All 	<p>Delete confidential and held jobs from the printer hard disk.</p> <p>Notes:</p> <ul style="list-style-type: none"> • Selecting a setting affects only print jobs that are resident in the printer. Bookmarks, print jobs on flash drives, and other types of held jobs are not affected. • Not Restored removes all Print and Hold jobs that are <i>not</i> restored from the printer hard disk or memory.

Use	To
Format Flash Yes No	Format the flash memory. Warning—Potential Damage: Do not turn off the printer while the flash memory is being formatted. Notes: <ul style="list-style-type: none"> • Yes deletes all data stored in flash memory. • No cancels the format request. • Flash memory refers to the memory added by installing a flash memory card in the printer. • The flash memory option card must not be read/write- or write-protected. • This menu item appears only when a non-defective flash memory card is installed.
Delete Downloads on Disk Delete Now Do Not Delete	Delete downloads from the printer hard disk, including all held jobs, buffered jobs, and parked jobs. Notes: <ul style="list-style-type: none"> • Delete Now sets the printer to delete the downloads and allows the display to return to the originating screen after the deletion. • Do Not Delete sets the printer to return to the originating screen after the deletion.
Activate Hex Trace	Assist in isolating the source of a print job problem. Notes: <ul style="list-style-type: none"> • When activated, all data sent to the printer is printed in hexadecimal and character representation, and control codes are not executed. • To exit or deactivate Hex Trace, turn off or reset the printer.
Coverage Estimator Off On	Provide an estimate of the percentage coverage of toner on a page. The estimate is printed on a separate page at the end of each print job. Note: Off is the factory default setting.

XPS menu

Use	To
Print Error Pages Off On	Print a page containing information on errors, including XML markup errors. Note: Off is the factory default setting.

PDF menu

Use	To
Scale to Fit Yes No	Scale page content to fit the selected paper size. Note: No is the factory default setting.

Use	To
Annotations Do Not Print Print	Print annotations in a PDF. Note: Do Not Print is the factory default setting.

PostScript menu

Use	To
Print PS Error On Off	Print a page containing the PostScript error. Note: Off is the factory default setting.
Lock PS Startup Mode On Off	Disable the SysStart file. Note: Off is the factory default setting.
Font Priority Resident Flash/Disk	Establish the font search order. Notes: <ul style="list-style-type: none"> • Resident is the factory default setting. • This menu item is available only when a formatted flash memory option card or printer hard disk is installed and operating properly. • Make sure the flash memory option or printer hard disk is not read/write-, write-, or password-protected. • Job Buffer Size must not be set to 100%.

PCL Emul menu

Use	To
Font Source Resident Disk Download Flash All	Specify the set of fonts used by the Font Name menu. Notes: <ul style="list-style-type: none"> • “Resident” is the factory default setting. Resident shows the factory default set of fonts downloaded in the RAM. • “Flash” and “Disk” settings show all fonts resident in that option. • The flash option must be properly formatted and cannot be read/write-, write-, or password-protected. • “Download” shows all the fonts downloaded in the RAM. • “All” shows all fonts available to any option.
Font Name Courier 10	Identify a specific font and the option where it is stored. Note: Courier 10 is the factory default setting. Courier 10 shows the font name, font ID, and the storage location in the printer. The font source abbreviation is R for Resident, F for Flash, K for Disk, and D for Download.

Use	To
Symbol Set 10U PC-8 12U PC-850	Specify the symbol set for each font name. Notes: <ul style="list-style-type: none"> • 10U PC-8 is the US factory default setting. 12U PC-850 is the international factory default setting. • A symbol set is a set of alphabetic and numeric characters, punctuation, and special symbols. Symbol sets support the different languages or specific programs such as math symbols for scientific text. Only the supported symbol sets are shown.
PCL Emulation Settings Point Size 1.00–1008.00	Change the point size for scalable typographic fonts. Notes: <ul style="list-style-type: none"> • 12 is the factory default setting. • Point size refers to the height of the characters in the font. One point equals approximately 0.014 inch. • Point sizes can be increased or decreased in 0.25-point increments.
PCL Emulation Settings Pitch 0.08–100	Specify the font pitch for scalable monospaced fonts. Notes: <ul style="list-style-type: none"> • 10 is the factory default setting. • Pitch refers to the number of fixed-space characters per inch (cpi). • Pitch can be increased or decreased in 0.01-cpi increments. • For nonscalable monospaced fonts, the pitch appears on the display but it cannot be changed.
PCL Emulation Settings Orientation Portrait Landscape	Specify the orientation of text and graphics on the page. Notes: <ul style="list-style-type: none"> • Portrait is the factory default setting. Portrait prints text and graphics parallel to the short edge of the page. • Landscape prints text and graphics parallel to the long edge of the page.
PCL Emulation Settings Lines per Page 1–255	Specify the number of lines that print on each page. Notes: <ul style="list-style-type: none"> • 60 is the US factory default setting. 64 is the international default setting. • The printer sets the amount of space between each line based on the Lines per Page, Paper Size, and Orientation settings. Select the Paper Size and Orientation you want before setting Lines per Page.
PCL Emulation Settings A4 Width 198 mm 203 mm	Set the printer to print on A4-size paper. Notes: <ul style="list-style-type: none"> • “198 mm” is the factory default setting. • The 203-mm setting sets the width of the page to allow printing of eighty 10-pitch characters.

Use	To
<p>PCL Emulation Settings Auto CR after LF On Off</p>	<p>Specify whether the printer automatically performs a carriage return (CR) after a line feed (LF) control command. Note: Off is the factory default setting.</p>
<p>PCL Emulation Settings Auto LF after CR On Off</p>	<p>Specify whether the printer automatically performs a line feed (LF) after a carriage return (CR) control command. Note: Off is the factory default setting.</p>
<p>Tray Renumber Assign MP Feeder Off None 0–199 Assign Tray [x] Off None 0–199 Assign Manual Paper Off None 0–199 Assign Manual Env Off None 0–199</p>	<p>Configure the printer to work with printer software or programs that use different source assignments for trays and feeders. Notes:</p> <ul style="list-style-type: none"> • “Off” is the factory default setting. • “None” ignores the Select Paper Feed command. This option appears only when it is selected by the PCL 5 interpreter. • “0–199” allows a custom setting to be assigned.
<p>Tray Renumber View Factory Defaults MPF Default = 8 T1 Default = 1 T1 Default = 4 T1 Default = 5 T1 Default = 20 T1 Default = 21 Env Default = 6 MPaper Default = 2 MEnv Default = 3</p>	<p>Display the factory default setting assigned to each tray or feeder.</p>
<p>Tray Renumber Restore Defaults Yes No</p>	<p>Restore all tray and feeder assignments to the factory default settings.</p>

HTML menu

Use		To
Font Name Albertus MT Antique Olive Apple Chancery Arial MT Avant Garde Bodoni Bookman Chicago Clarendon Cooper Black Copperplate Coronet Courier Eurostile Garamond Geneva Gill Sans Goudy Helvetica Hoefler Text Intl CG Times Intl Courier Intl Univers	Joanna MT Letter Gothic Lubalin Graph Marigold MonaLisa Recut Monaco New CenturySbk New York Optima Oxford Palatino StempelGaramond Taffy Times TimesNewRoman Univers Zapf Chancery NewSansMTJA NewSansMTCS NewSansMTCT NewSansMTKO	Set the default font for HTML documents. Note: The Times font is used in HTML documents that do not specify a font.

Use	To
Font Size 1–255 pt	Set the default font size for HTML documents. Notes: <ul style="list-style-type: none"> • 12 pt is the factory default setting. • Font size can be increased in 1-point increments.
Scale 1–400%	Scale the default font for HTML documents. Notes: <ul style="list-style-type: none"> • 100% is the factory default setting. • Scaling can be increased in 1% increments.
Orientation Portrait Landscape	Set the page orientation for HTML documents. Note: Portrait is the factory default setting.
Margin Size 8–255 mm	Set the page margin for HTML documents. Notes: <ul style="list-style-type: none"> • 19 mm is the factory default setting. • Margin size can be increased in 1-mm increments.

Use	To
Backgrounds Do Not Print Print	Specify whether to print backgrounds on HTML documents. Note: Print is the factory default setting.

Image menu

Use	To
Auto Fit On Off	Select the optimal paper size, scaling, and orientation. Note: On is the factory default setting. It overrides scaling and orientation settings for some images.
Invert On Off	Invert bitonal monochrome images. Notes: <ul style="list-style-type: none"> • Off is the factory default setting. • This setting does not apply to GIF or JPEG images.
Scaling Anchor Top Left Best Fit Anchor Center Fit Height/Width Fit Height Fit Width	Scale the image to fit the selected paper size. Notes: <ul style="list-style-type: none"> • Best Fit is the factory default setting. • When Auto Fit is set to On, Scaling is automatically set to Best Fit.
Orientation Portrait Landscape Reverse Portrait Reverse Landscape	Set the image orientation. Note: Portrait is the factory default setting.

Help menu

Menu item	Description
Print All Guides	Prints all the guides
Print Quality	Provides information about solving print quality issues
Printing Guide	Provides information about loading paper and other specialty media
Media Guide	Provides a list of the paper sizes supported in trays and feeders
Print Defects Guide	Provides a template for determining the cause of repeating print quality defects, and lists settings that can be used to adjust print quality
Menu Map	Provides a list of the control panel menus and settings
Information Guide	Provides help in locating additional information
Connection Guide	Provides information about connecting the printer locally (USB) or to a network

Menu item	Description
Moving Guide	Provides instructions for safely moving the printer
Supplies Guide	Provides information about ordering supplies

Saving money and the environment

Lexmark is committed to environmental sustainability and is continually improving its printers to reduce their impact on the environment. We design with the environment in mind, engineer our packaging to reduce materials, and provide collection and recycling programs. For more information, see:

- The Notices chapter
- The Environmental Sustainability section of the Lexmark Web site at www.lexmark.com/environment
- The Lexmark recycling program at www.lexmark.com/recycle

By selecting certain printer settings or tasks, you may be able to reduce your printer's impact even further. This chapter outlines the settings and tasks that may yield a greater environmental benefit.

Saving paper and toner

Studies show that as much as eighty percent of the carbon footprint of a printer is related to paper usage. You can significantly reduce your carbon footprint by using recycled paper and the following printing suggestions, such as printing on both sides of the paper and printing multiple pages on one side of a single sheet of paper.

Using recycled paper

As an environmentally conscious company, Lexmark supports the use of recycled office paper produced specifically for use in laser printers. For more information on recycled papers that work well with your printer, see [“Using recycled paper and other office papers” on page 57](#).

Conserving supplies

Use both sides of the paper

If your printer model supports two-sided printing, then you can control whether print appears on one or two sides of the paper.

Notes:

- Two-sided printing is the default setting in the print driver.
- For a complete list of supported products and countries, go to <http://support.lexmark.com>.

Place multiple pages on one sheet of paper

You can print up to 16 consecutive pages of a multiple-page document onto one side of a single sheet of paper by setting multiple page printing (N-Up) for the print job.

Check your first draft for accuracy

Before printing or making multiple copies of a document:

- Use the preview feature to see how the document looks like before you print it.
- Print one copy of the document to check its content and format for accuracy.

Avoid paper jams

Correctly set the paper type and size to avoid paper jams. For more information, see [“Avoiding jams” on page 164](#).

Saving energy

Using Hibernate mode

Hibernate is an ultra-low-power saving mode.

Notes:

- Three days is the default amount of time before the printer enters Hibernate mode.
- Make sure to wake the printer from Hibernate mode before sending a print job. A hard reset or a long press of the Sleep button wakes the printer from Hibernate mode.
- If the printer is in Hibernate mode, then the Embedded Web Server is disabled.

1 From the home screen, navigate to:



> **Settings** > **General Settings**

2 Touch **Press Sleep Button** or **Press and Hold Sleep Button**.

3 Touch **Hibernate** > .

Using Eco-Mode

1 Open a Web browser, and then type the printer IP address in the address field.

Notes:

- View the printer IP address on the printer home screen. The IP address appears as four sets of numbers separated by periods, such as 123.123.123.123.
- If you are using a proxy server, then temporarily disable it to load the Web page correctly.

2 Click **Settings** > **General Settings** > **Eco-Mode** > select a setting

Use	To
Off	Use the factory default settings for all settings associated with Eco-Mode. Off supports the performance specifications of the printer.
Energy	Reduce energy use, especially when the printer is idle. <ul style="list-style-type: none"> • Printer engine motors do not start until it is ready to print. You may notice a short delay before the first page is printed. • The printer enters Sleep mode after one minute of inactivity.
Energy/Paper	Use all the settings associated with Energy and Paper modes.
Plain Paper	<ul style="list-style-type: none"> • Enable the automatic two-sided (duplex) feature. • Turn off print log features.

3 Click **Submit**.

Adjusting Sleep mode

1 From the home screen, navigate to:



> **Settings** > **General Settings** > **Timeouts** > **Sleep Mode**

2 In the Sleep Mode field, select the number of minutes the printer is idle before it enters Sleep mode.

3 Apply the changes.

Adjusting the brightness of the printer display

To save energy, or if you have trouble reading the display, adjust its brightness settings.

Using the Embedded Web Server

1 Open a Web browser, and then type the printer IP address in the address field.

Notes:

- View the printer IP address in the TCP/IP section in the Network/Ports menu. The IP address appears as four sets of numbers separated by periods, such as 123.123.123.123.
- If you are using a proxy server, then temporarily disable it to load the Web page correctly.

2 Click **Settings** > **General Settings**.

3 In the Screen Brightness field, enter the brightness percentage you want for the display.

4 Click **Submit**.

Recycling

Lexmark provides collection programs and environmentally progressive approaches to recycling. For more information, see:

- The Notices chapter
- The Environmental Sustainability section of the Lexmark Web site at www.lexmark.com/environment
- The Lexmark recycling program at www.lexmark.com/recycle

Recycling Lexmark products

To return Lexmark products for recycling:

1 Go to www.lexmark.com/recycle.

2 Find the product type you want to recycle, and then select your country or region from the list.

3 Follow the instructions on the computer screen.

Note: Printer supplies and hardware not listed in the Lexmark collection program may be recycled through your local recycling center. Contact your local recycling center to determine the items they accept.

Recycling Lexmark packaging

Lexmark continually strives to minimize packaging. Less packaging helps to ensure that Lexmark printers are transported in the most efficient and environmentally sensitive manner and that there is less packaging to dispose of. These efficiencies result in fewer greenhouse emissions, energy savings, and natural resource savings.

Lexmark cartons are 100% recyclable where corrugated recycling facilities exist. Facilities may not exist in your area.

The foam used in Lexmark packaging is recyclable where foam recycling facilities exist. Facilities may not exist in your area.

When you return a cartridge to Lexmark, you can reuse the box that the cartridge came in. Lexmark will recycle the box.

Returning Lexmark cartridges for reuse or recycling

Lexmark Cartridge Collection Program diverts millions of Lexmark cartridges from landfills annually by making it both easy and free for Lexmark customers to return used cartridges to Lexmark for reuse or recycling. One hundred percent of the empty cartridges returned to Lexmark are either reused or demanufactured for recycling. Boxes used to return the cartridges are also recycled.

To return Lexmark cartridges for reuse or recycling, follow the instructions that came with your printer or cartridge and use the prepaid shipping label. You can also do the following:

- 1** Go to www.lexmark.com/recycle.
- 2** From the Toner Cartridges section, select your country or region.
- 3** Follow the instructions on the computer screen.

Securing the printer

Using the security lock feature

The printer is equipped with a security lock feature. When a lock compatible with most laptop computers is attached, the printer is locked. When locked, the controller board shield and the controller board cannot be removed. Attach a security lock to the printer in the location shown.

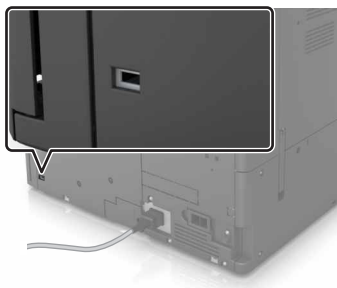

Statement of Volatility

Your printer contains various types of memory that can store device and network settings, and user data.

Type of memory	Description
Volatile memory	Your printer uses standard <i>random access memory</i> (RAM) to temporarily buffer user data during simple print jobs.
Non-volatile memory	Your printer may use two forms of non-volatile memory: EEPROM and NAND (flash memory). Both types are used to store the operating system, device settings, network information, bookmark settings, and embedded solutions.
Hard disk memory	Some printers have a hard disk drive installed. The printer hard disk is designed for device-specific functionality. This lets the device retain buffered user data from complex print jobs, as well as form data, and font data.

Erase the content of any installed printer memory in the following circumstances:

- The printer is being decommissioned.
- The printer hard disk is being replaced.
- The printer is being moved to a different department or location.
- The printer is being serviced by someone from outside your organization.
- The printer is being removed from your premises for service.
- The printer is being sold to another organization.

Disposing of a printer hard disk

Note: Some printer models may not have a printer hard disk installed.

In high-security environments, it may be necessary to take additional steps to make sure that confidential data stored in the printer hard disk cannot be accessed when the printer—or its hard disk—is removed from your premises.

- **Degaussing**—Flushes the hard disk with a magnetic field that erases stored data
- **Crushing**—Physically compresses the hard disk to break component parts and render them unreadable
- **Milling**—Physically shreds the hard disk into small metal bits

Note: Most data can be erased electronically, but the only way to guarantee that all data is completely erased is to physically destroy each hard disk where data is stored.

Erasing volatile memory

The volatile memory (RAM) installed in your printer requires a power source to retain information. To erase the buffered data, simply turn off the printer.

Erasing non-volatile memory

Erase individual settings, device and network settings, security settings, and embedded solutions by following these steps:

- 1 Turn off the printer.
- 2 From the control panel, hold down **2** and **6** while turning the printer on. Release the buttons when the screen with the progress bar appears.
- 3 From the Configuration menu, navigate to:
Restore Factory Defaults > Erase Printer Memory > Yes

The printer restarts several times during this process.

- 4 Touch **Back**, and then exit the Configuration menu.

Note: The printer performs a power-on reset, and then returns to normal operating mode.

Erasing printer hard disk memory

- 1 Turn off the printer.
- 2 From the control panel, hold down **2** and **6** while turning the printer on. Release the buttons when the screen with the progress bar appears.
- 3 From the Configuration menu, navigate to:
Restore Factory Defaults > Erase Hard Disk > select the method to erase the hard disk memory > Yes

Note: This process can take from several minutes to more than an hour, during which the printer is unavailable for other user tasks.

- 4 Touch **Back**, and then exit the Configuration menu.

Note: The printer performs a power-on reset, and then returns to normal operating mode.

Configuring printer hard disk encryption

Enable hard disk encryption to prevent loss of sensitive data in the event the printer or its hard disk is stolen.

Note: Some printer models may not have a hard disk installed.

- 1 Turn off the printer.
- 2 From the control panel, hold down **2** and **6** while turning the printer on. Release the buttons only when the screen with the progress bar appears.
- 3 Touch **Disk Encryption > Enable**.

Note: Enabling disk encryption erases the contents of the hard disk.

- 4 Touch **Yes** to proceed with disk wiping.

Notes:

- Do not turn off the printer during the encryption process. Doing so may result in loss of data.
- Disk encryption can take from several minutes to more than an hour, during which the printer is unavailable for other user tasks.
- A status bar indicates the progress of the disk wiping task. After the disk is encrypted, the printer returns to the Enable/Disable screen.

- 5 Touch **Back**, and then exit the Configuration menu.

Note: The printer performs a power-on reset, and then returns to normal operating mode.

Finding the printer security information

Finding the printer security information

In high-security environments, it may be necessary to take additional steps to make sure that confidential data stored in the printer cannot be accessed by unauthorized persons. For more information, go to the [Lexmark security Web page](#) or see the *Embedded Web Server—Security: Administrator's Guide* at <http://support.lexmark.com>.

Maintaining the printer

Warning—Potential Damage: Failure to maintain optimum printer performance, or to replace parts and supplies, may cause damage to your printer.

Updating firmware

Updating the firmware using the control panel

Using the notification center

This method is applicable only in some printer models.

- 1 From the control panel, navigate to the notification center, and then select **Firmware update available**.

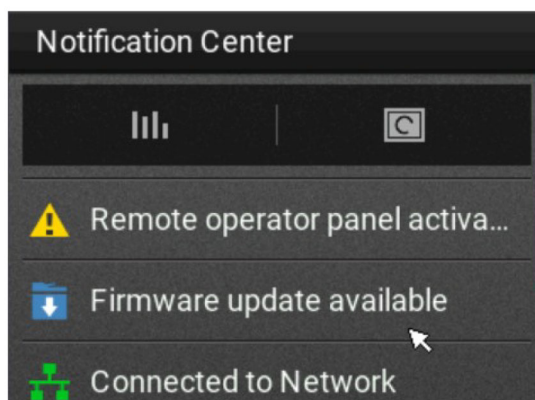

- 2 Select **Install now**.

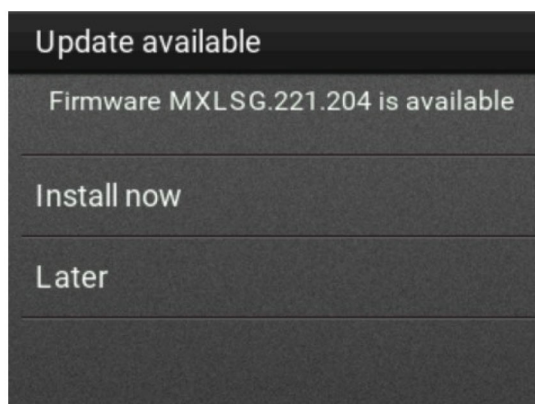

The printer reboots automatically after the update.

Using the Settings menu

- 1 From the control panel, navigate to **Settings > Device > Update Firmware**.
- 2 Depending on your printer model, select **Check for updates** or **Check for updates now**.
- 3 If a new update is available, then select **Install now**.

The printer reboots automatically after the update.

Updating the firmware using the Embedded Web Server

Before you begin, make sure that:

- You have downloaded the latest printer firmware from <https://support.lexmark.com> and saved it to your flash drive or computer.

Note: To deploy the printer firmware, extract the .fls firmware file from the ZIP package.

- You are not using a special code on your printer to avoid losing this functionality.

Warning—Potential Damage: Make sure that all printers receiving firmware updates are turned on during the entire firmware update process. Turning off a printer during a firmware update can severely damage it.

If the printer is connected to the network when checking for updates, then downloading the firmware is not required.

- 1 Open a web browser, and then type the printer IP address in the address field.

Notes:

- View the printer IP address on the printer home screen. The IP address appears as four sets of numbers separated by periods, such as 123.123.123.123.
- If you are using a proxy server, then temporarily disable it to load the web page correctly.

- 2 Click **Device**.
- 3 Scroll down, and then click **Update Firmware**.
- 4 Depending on your printer model, click **Check for updates** or **Check for updates now**.
If a new update is available, then click **I agree, start update**.

The printer reboots automatically after the update.

Cleaning printer parts

Cleaning the printer

Note: You may need to perform this task after every few months.

Warning—Potential Damage: Damage to the printer caused by improper handling is not covered by the printer warranty.

- 1 Make sure that the printer is turned off and unplugged from the electrical outlet.

 **CAUTION—SHOCK HAZARD:** To avoid the risk of electrical shock when cleaning the exterior of the printer, unplug the power cord from the electrical outlet and disconnect all cables from the printer before proceeding.

- 2 Remove paper from the standard bin and multipurpose feeder.
- 3 Remove any dust, lint, and pieces of paper around the printer using a soft brush or vacuum.
- 4 Dampen a clean, lint-free cloth with water, and use it to wipe the outside of the printer.

Warning—Potential Damage: Do not use household cleaners or detergents to prevent damage to the exterior of the printer.

- 5 Make sure all areas of the printer are dry before sending a new print job.

Cleaning the charger and the printhead lens

- 1 Open the bottom front door.

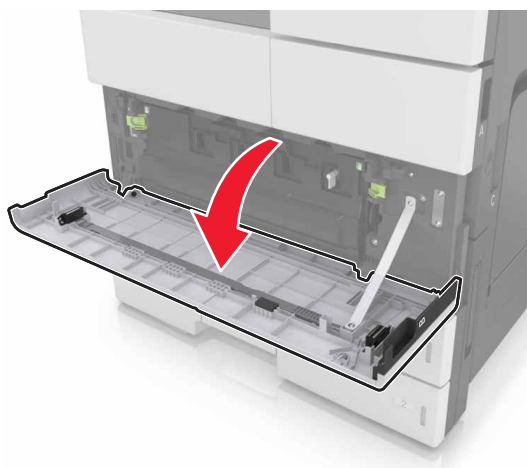

2 Remove the waste toner bottle.

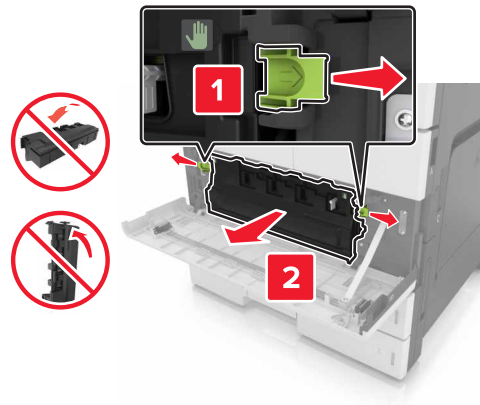

3 Locate the white tab.

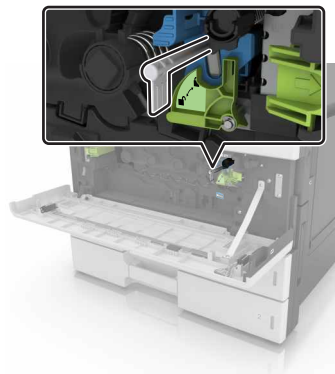

4 Gently pull the tab until it stops, and then slowly slide it back into place. Repeat three times.

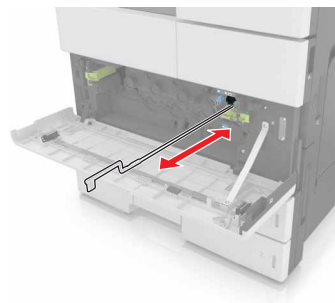

5 Remove the printhead wiper.

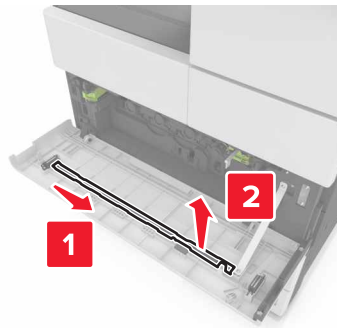

6 Insert the wiper into the hole until it stops, and then slide it out. Repeat three times.

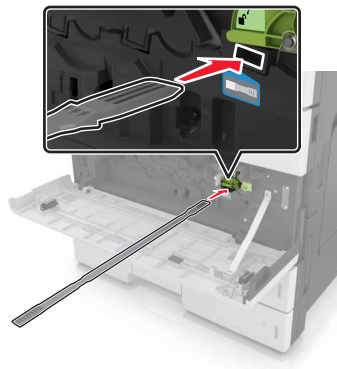

7 Put the wiper back to its holder.

8 Reinstall the waste toner bottle.

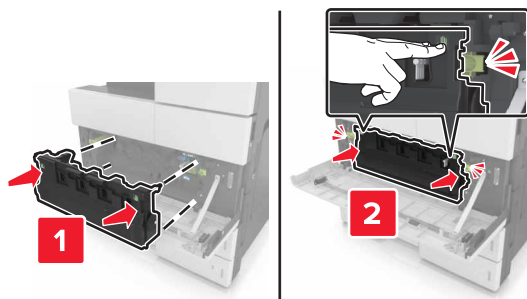

9 Close the bottom front door.

Emptying the hole punch box

1 Open door H.



2 Remove and empty the hole punch box.

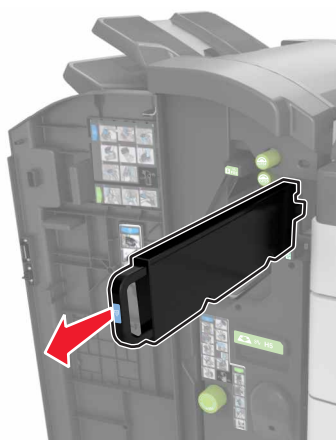

- 3 Reinstall the hole punch box.

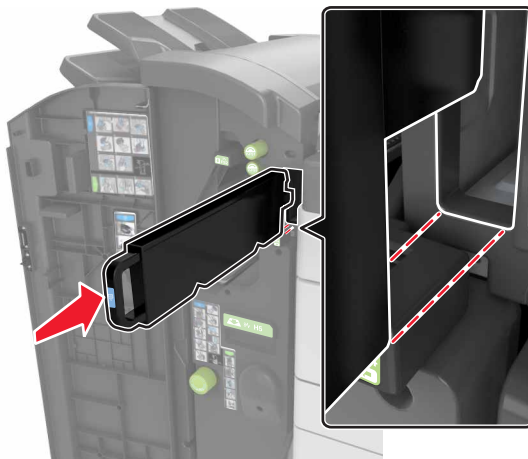

- 4 Close door H.

Checking the status of parts and supplies

A message appears on the printer display when a replacement supply item is needed or when maintenance is required.

Checking the status of parts and supplies on the printer control panel

From the home screen, touch **Status/Supplies > View Supplies**.

Checking the status of parts and supplies from the Embedded Web Server

Note: Make sure the computer and the printer are connected to the same network.

- 1 Open a Web browser, and then type the printer IP address in the address field.

Notes:

- View the printer IP address on the home screen. The IP address appears as four sets of numbers separated by periods, such as 123.123.123.123.
- If you are using a proxy server, then temporarily disable it to load the Web page correctly.

- 2 Click **Device Status > More Details**.

Estimated number of remaining pages

The estimated number of remaining pages is based on the recent printing history of the printer. Its accuracy may vary significantly and is dependent on many factors, such as actual document content, print quality settings, and other printer settings.

The accuracy of the estimated number of remaining pages may decrease when the actual printing consumption is different from the historical printing consumption. Consider the variable level of accuracy before purchasing or replacing supplies based on the estimate. Until an adequate print history is obtained on the printer, initial estimates assume future supplies consumption based on the International Organization for Standardization* test methods and page content.

* Average continuous black declared cartridge yield in accordance with ISO/IEC 19752.

Ordering supplies

To order parts and supplies in the U.S., contact Lexmark at 1-800-539-6275 for information about Lexmark Authorized Supplies Dealers in your area. In other countries or regions, go to the Lexmark Web site at www.lexmark.com or contact the place where you purchased the printer.

Using genuine Lexmark parts and supplies

Your Lexmark printer is designed to function best with genuine Lexmark supplies and parts. Use of third-party supplies or parts may affect the performance, reliability, or life of the printer and its imaging components. Use of third-party supplies or parts can affect warranty coverage. Damage caused by the use of third-party supplies or parts is not covered by the warranty. All life indicators are designed to function with Lexmark supplies and parts, and may deliver unpredictable results if third-party supplies or parts are used. Imaging component usage beyond the intended life may damage your Lexmark printer or its associated components.

Ordering a toner cartridge

Notes:

- The estimated cartridge yield is based on the ISO/IEC 19752 standard.
- Extremely low print coverage for extended periods of time may negatively affect actual yield.

Part name	Part number
High Yield Toner Cartridge	54G0H00

Ordering a photoconductor unit

Extremely low print coverage for extended periods of time may cause photoconductor unit parts to fail prior to exhaustion of toner.

Item	Part number
Photoconductor unit	54G0P00

Ordering a waste toner bottle

Item	Part number
Waste toner bottle	54G0W00

Ordering staple cartridges

Item	Part number
Staple cartridges	25A0013

Ordering a 300K maintenance kit

Note: To replace the parts included in the maintenance kit, see the instruction sheet that came with each part.

Item	Part number
Maintenance kit	40X9669

Storing parts and supplies

Storing supplies

Choose a cool, clean storage area for the printer supplies. Store supplies right side up in their original packing until you are ready to use them.

Do not expose supplies to:

- Direct sunlight
- Temperatures above 35°C (95°F)
- High humidity above 80%
- Salty air
- Corrosive gases
- Heavy dust

Storing the rollers

Your printer comes with replacement rollers stored in the compartment inside the standard trays. After you purchase new rollers, make sure to store them in the compartments inside the trays.

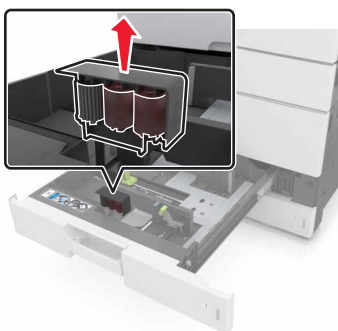

Note: For proper disposal of parts and supplies, see [“Recycling” on page 126](#).

Replacing supplies

To avoid spilling the toner from the waste toner bottle, make sure to maintain its orientation.

Replacing a photoconductor unit

- 1 Open the bottom front door.



- 2 Remove the waste toner bottle.

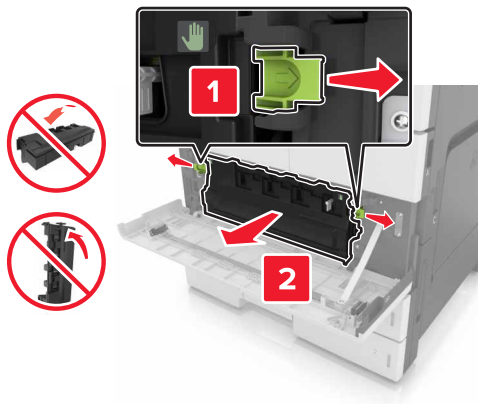

3 Unlock the photoconductor unit.

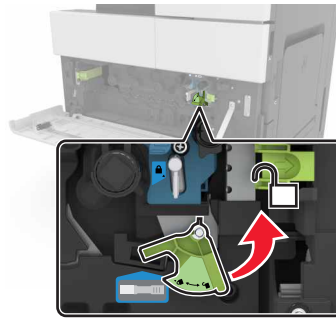

4 Remove the photoconductor unit.

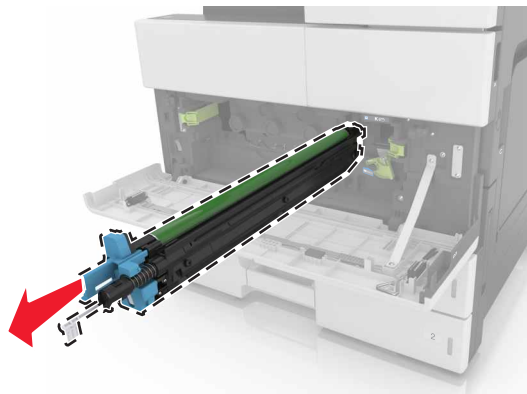

5 Unpack the new photoconductor unit.

Warning—Potential Damage: Do not expose the photoconductor unit to direct light for more than 10 minutes. Extended exposure to light may cause print quality problems.

Warning—Potential Damage: Do not touch the photoconductor drum. Doing so may affect the print quality of future print jobs.

6 Install the photoconductor unit.

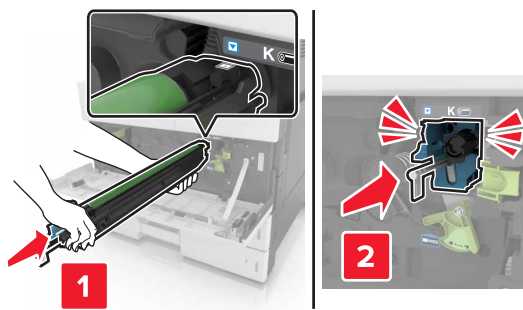

7 Lock the photoconductor unit.

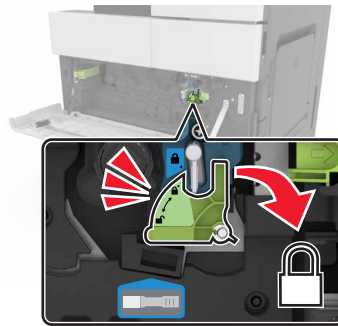

8 Reinstall the waste toner bottle.

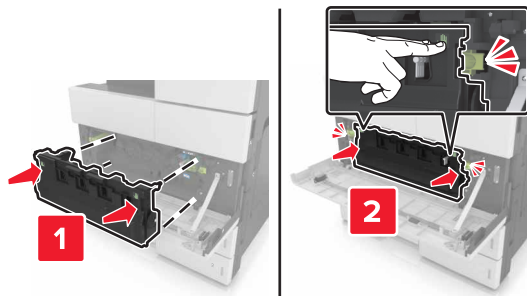

9 Close the bottom front door.

Replacing the staple cartridge

Replacing the staple cartridge in the staple finisher

Note: The staple finisher is supported only in select printer models.

1 Press the latch on the staple finisher, and then slide the finisher to the left.

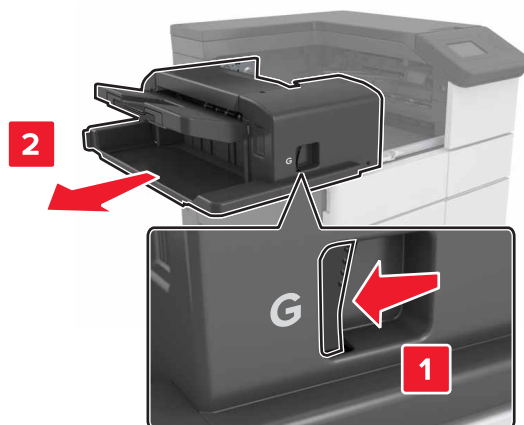

2 Remove the staple cartridge holder.



3 Remove the empty staple cartridge from the cartridge holder.

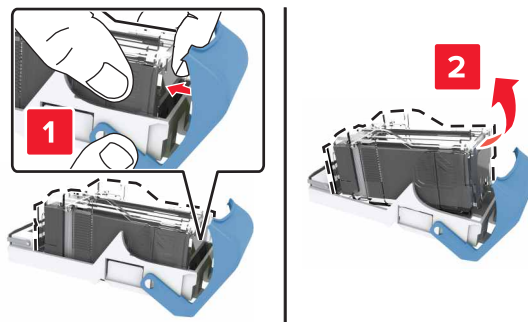

4 Insert the new cartridge into the cartridge holder.

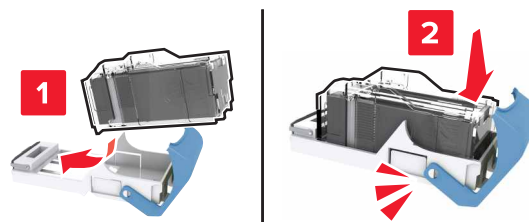

5 Push the cartridge holder into the finisher until the holder *clicks* into place.

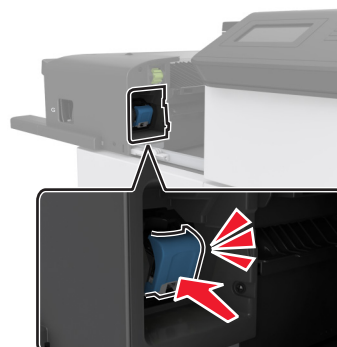

6 Slide the finisher back into place.

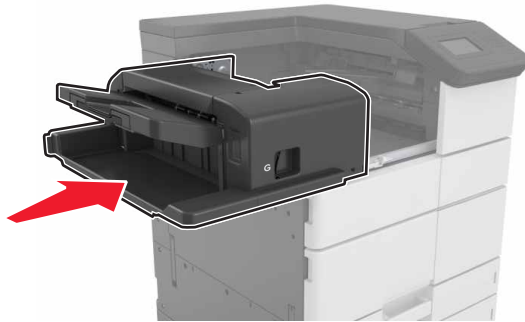

Replacing the staple cartridge in the booklet finisher

1 Open door H, and then pull out the booklet maker.



2 Remove the staple cartridge holder.

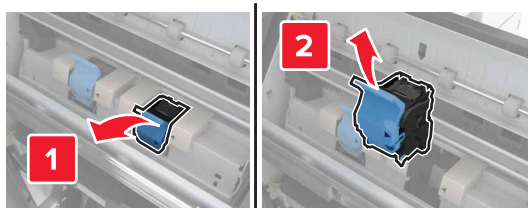

3 Remove the empty staple cartridge from the cartridge holder.

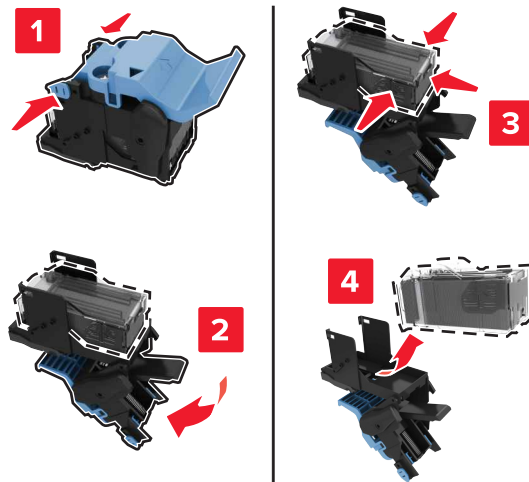

4 Insert the new cartridge into the cartridge holder.

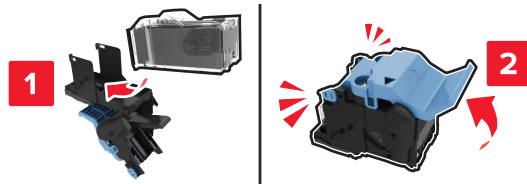

5 Push the cartridge holder into the booklet maker until the holder *clicks* into place.

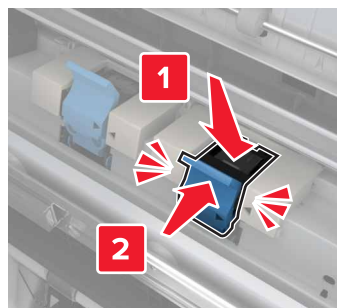

6 Push the booklet maker back into place, and then close the door.

Replacing the staple cartridge in the staple, hole punch finisher

- 1 Open door H.

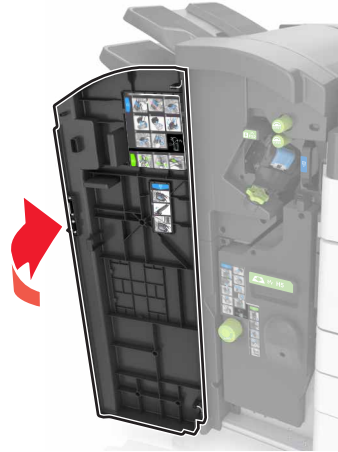

- 2 Remove the staple cartridge holder.

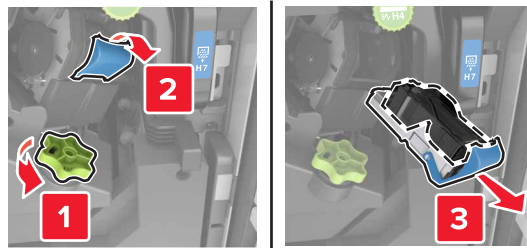

- 3 Remove the empty staple cartridge from the cartridge holder.

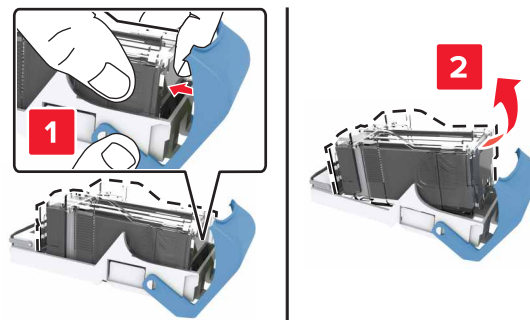

4 Insert the new cartridge into the cartridge holder.

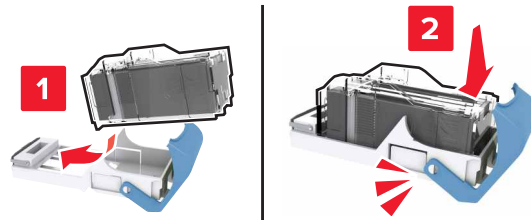

5 Push the cartridge holder into the finisher until the holder *clicks* into place.



6 Close door H.

Replacing the toner cartridge

1 Open the top front door.



2 Rotate the toner cartridge counterclockwise, and then pull it out.



- 3** Unpack the new toner cartridge, remove the packing material, and then shake the cartridge to redistribute the toner.

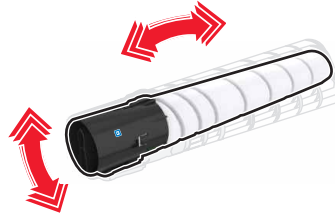

- 4** Insert the toner cartridge into the printer.



- 5** Rotate the cartridge clockwise to lock it into place.

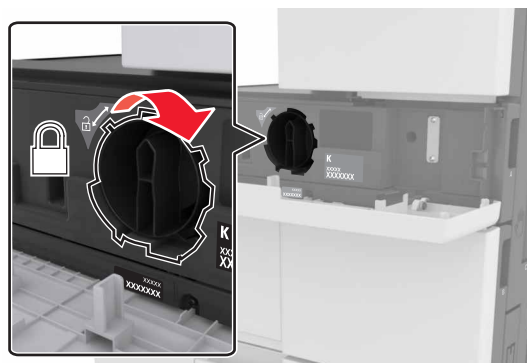

- 6 Close the top front door.



- 7 Clean the charger and the printhead lens. For more information, see [“Cleaning the charger and the printhead lens” on page 133](#).

Replacing the waste toner bottle

- 1 Open the bottom front door.



- 2 Remove the waste toner bottle.

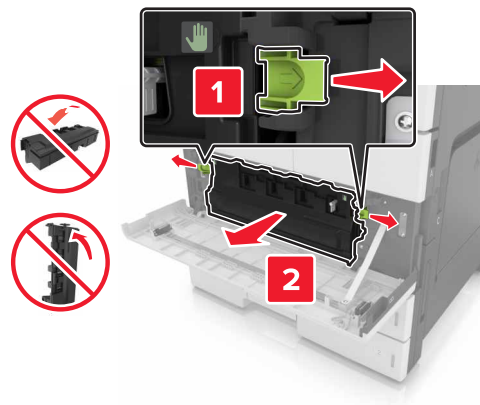

- 3 Clean the charger and the printhead lens. For more information, see steps 3–7 of [“Cleaning the charger and the printhead lens”](#) on page 133.
- 4 Unpack the new waste toner bottle.
- 5 Insert the new waste toner bottle into the printer until it *clicks* into place.

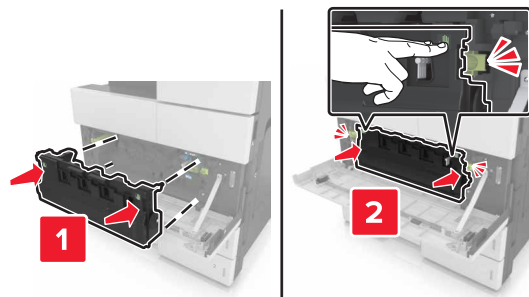

- 6 Close the bottom front door.

Replacing the 300K maintenance kit

Replacing the exhaust and ozone filters

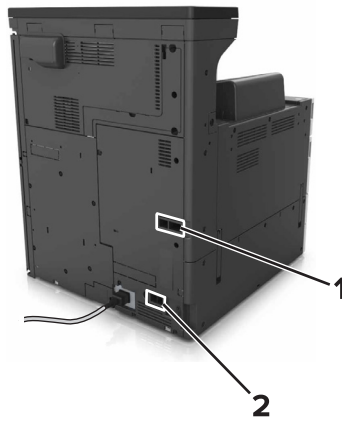

1	Exhaust filter
2	Ozone filter

Replacing the exhaust filter

- 1** Pull out the exhaust filter.

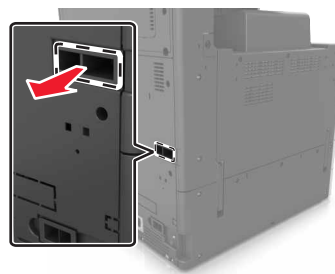

- 2** Unpack the new exhaust filter.

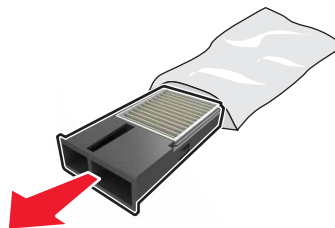

3 Insert the new filter.



Replacing the ozone filter

1 Pull out the ozone filter.

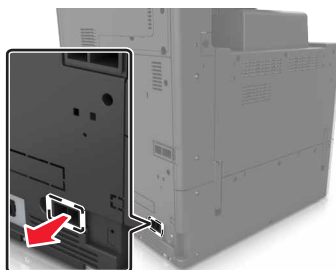

2 Unpack the new ozone filter.

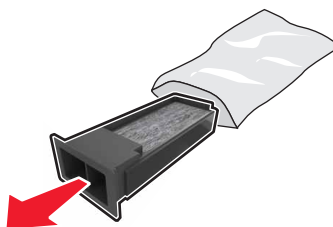

3 Insert the new filter.

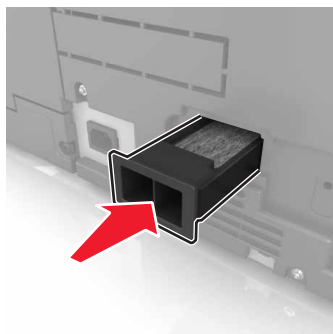

Replacing the pick, feed, and separator rollers

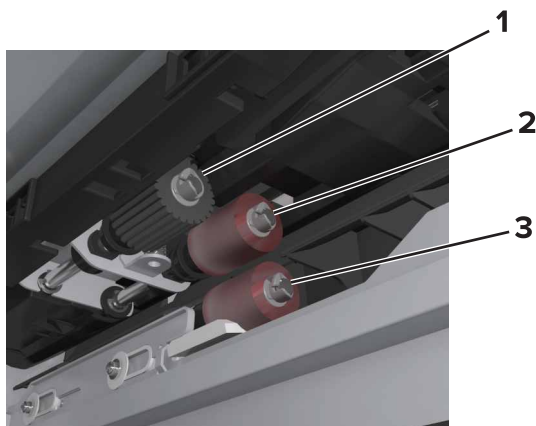

1	Pick roller
2	Feed roller
3	Separator roller

Note: You can use the rollers stored in the compartment inside the standard trays. For more information, see [“Storing the rollers” on page 139](#).

- 1 Turn off the printer.

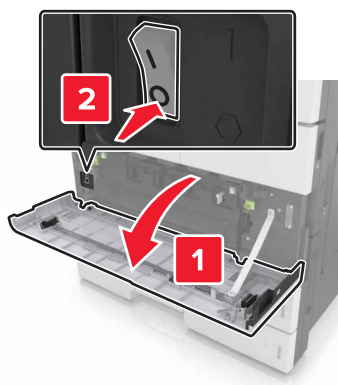

2 Remove all trays.

- Standard tray

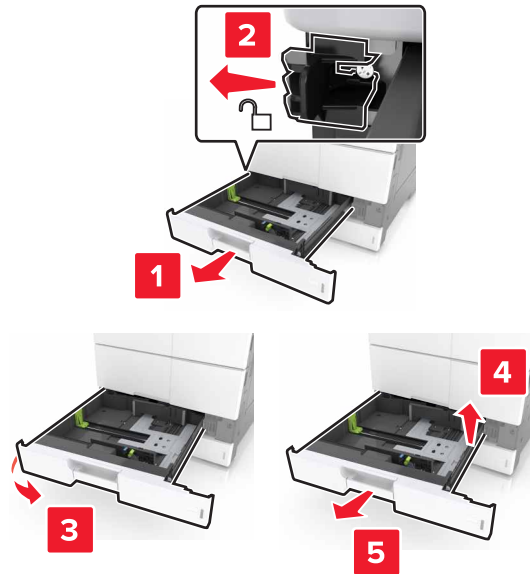

- Optional 2 x 500- or 2500-sheet tray

Note: To remove the optional 2 x 500-sheet tray, follow the procedure in removing the standard tray.

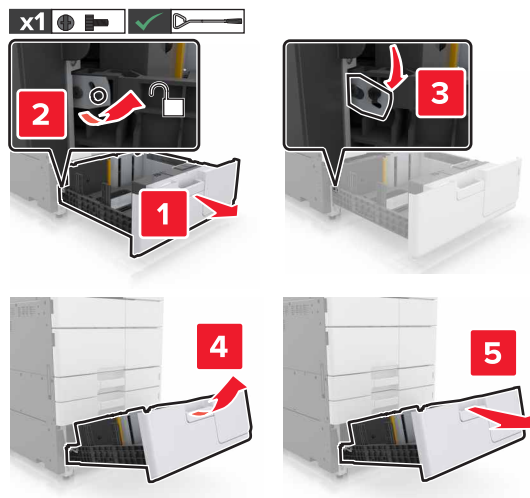

3 Open door C. Make sure that it does not hit any cable attached to the printer.

Note: If the 3000-sheet tray is installed, slide the tray to open the door.

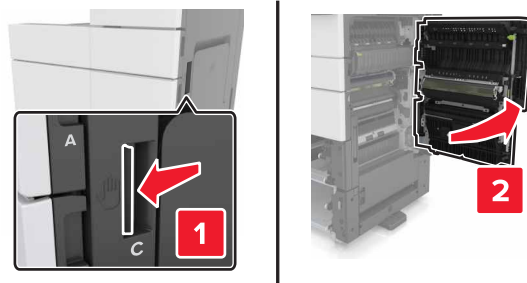

4 Open door D.

Notes:

- You can only open door D if the optional 2 x 500- or 2500-sheet tray is installed.
- If the 3000-sheet tray is installed, slide the tray to open the door.

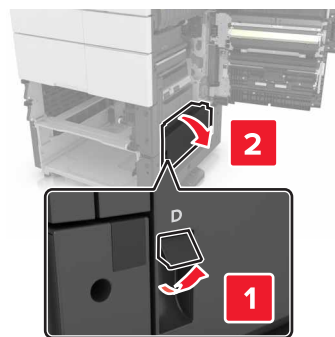

5 Locate the rollers.

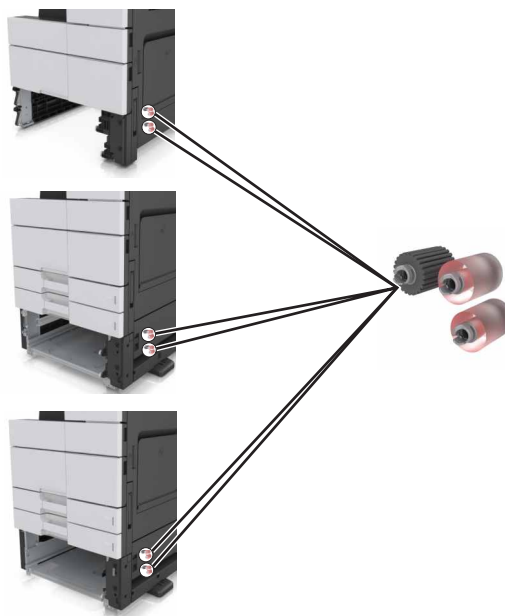

6 Remove the rollers.

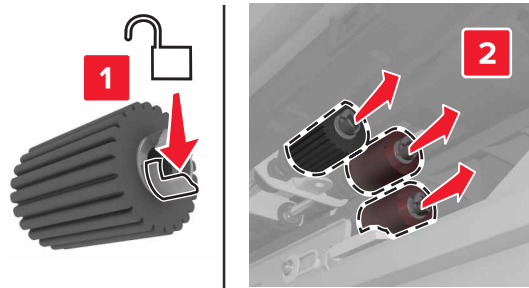

7 Insert the new rollers until they *click* into place.

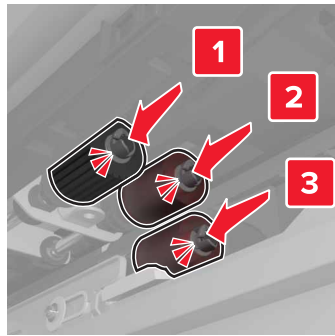

Note: Make sure to insert the rollers to their right places.

8 Close doors C and D.

9 Insert the trays.

Replacing the transfer module

Note: Use the screwdriver located inside the bottom front door of the printer.

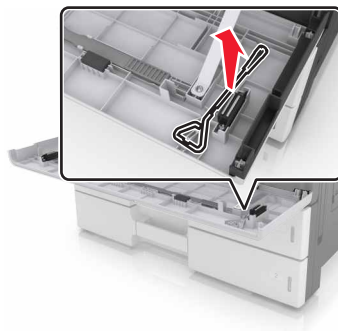

- 1 Turn off the printer.

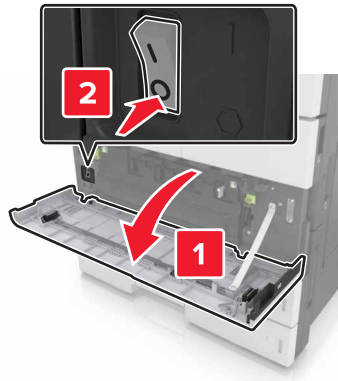

- 2 Open door C. Make sure that it does not hit any cable attached to the printer.

CAUTION—HOT SURFACE: The inside of the printer might be hot. To reduce the risk of injury from a hot component, allow the surface to cool before touching it.

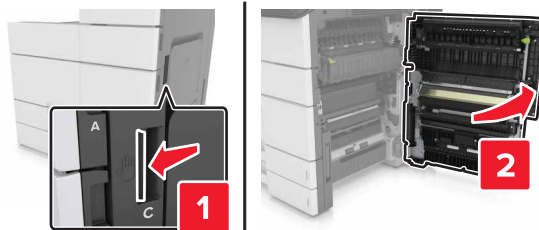

Note: If the 3000-sheet tray is installed, then slide the tray to the right to open the door.

- 3 Remove the door stopper.

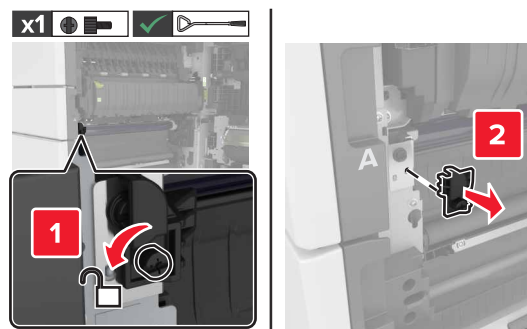

4 Loosen the screws of the transfer module lock.

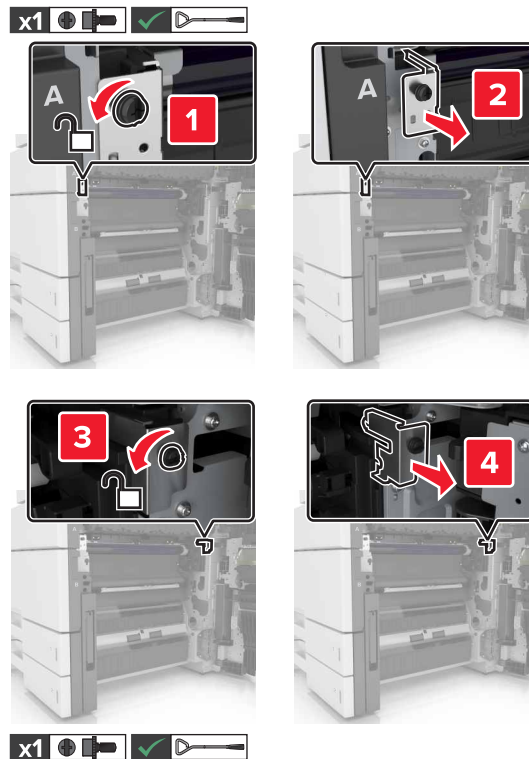

5 Remove the paper guide.

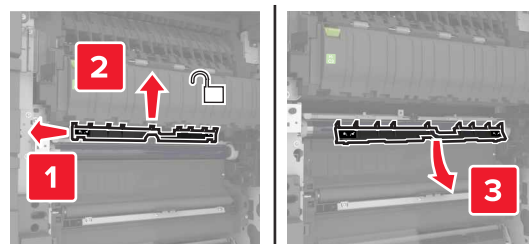

6 Lift the transfer module using the handles, and then pull it out completely.

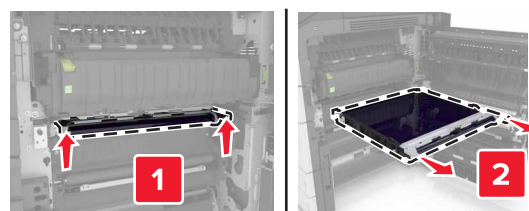

7 Unpack the new transfer module.

Warning—Potential Damage: Do not expose the transfer belt to direct light for more than 10 minutes. Extended exposure to light may cause print quality problems.

Warning—Potential Damage: Do not touch the transfer belt. Doing so may affect the print quality of future print jobs.



8 Insert the new transfer module until it *clicks* into place.

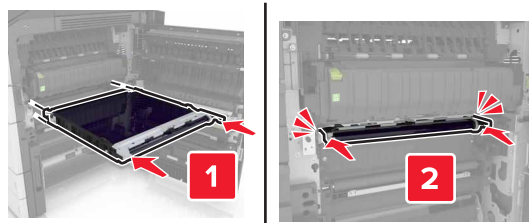

9 Place the paper guide back into place.

10 Tighten the screws of the transfer module lock.

11 Reinstall the door stopper.

12 Close door C.

Replacing the transfer roller

1 Open door C. Make sure that it does not hit any cable attached to the printer.

Note: If the 3000-sheet tray is installed, then slide the tray to the right to open the door.

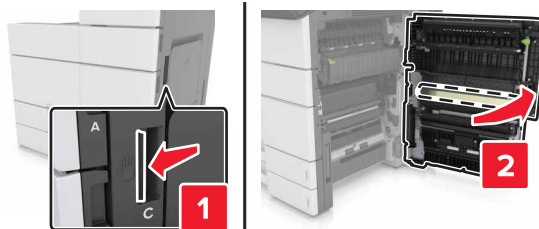

- 2 Pull out the transfer roller.

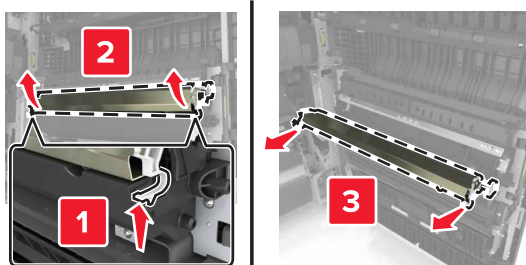

- 3 Unpack the new transfer roller.
- 4 Insert the new transfer roller until it *clicks* into place.

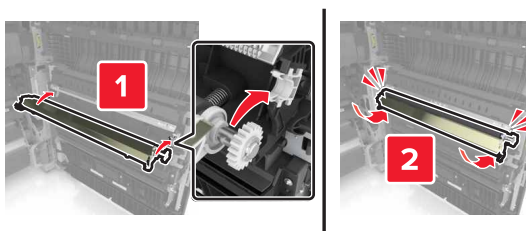

- 5 Close door C.

Resetting the maintenance counter

- 1 Turn off the printer.
- 2 From the control panel, hold down **2** and **6** while turning the printer on. Release the buttons when the screen with the progress bar appears.
- 3 From the Configuration menu, navigate to:
Reset Maintenance Counter > Reset 300K Maintenance Kit
- 4 Touch **Back**, and then exit the Configuration menu.

Note: The printer performs a power-on reset, and then returns to normal operating mode.

Moving the printer

 **CAUTION—POTENTIAL INJURY:** The printer weight is greater than 18 kg (40 lb) and requires two or more trained personnel to lift it safely.

Before moving the printer

 **CAUTION—POTENTIAL INJURY:** Before moving the printer, follow these guidelines to avoid personal injury or printer damage:

- Turn off the printer, and then unplug the power cord from the electrical outlet.
- Disconnect all cords and cables from the printer.
- If the printer does not have a caster base but is configured with optional trays, then remove the trays.
- Use the handholds located on both sides of the printer to lift it.
- Make sure your fingers are not under the printer when you set it down.
- Make sure there is adequate clearance around the printer.
- Use only the power cord provided with this product or the manufacturer's authorized replacement.

Warning—Potential Damage: Damage to the printer caused by improper moving is not covered by the printer warranty.

Moving the printer to another location

The printer and its hardware options can be safely moved to another location by following these precautions:

- Any cart used to move the printer must have a surface able to support the full footprint of the printer.
- Any cart used to move the hardware options must have a surface able to support the dimensions of the hardware options.
- Keep the printer in an upright position.
- Avoid severe jarring movements.

Shipping the printer

When shipping the printer, use the original packaging.

Managing the printer

Checking the virtual display

- 1 Open a Web browser, and then type the printer IP address in the address field.

Notes:

- View the printer IP address on the printer home screen. The IP address appears as four sets of numbers separated by periods, such as 123.123.123.123.
- If you are using a proxy server, then temporarily disable it to load the Web page correctly.

- 2 Check the virtual display that appears in the top left corner of the screen.

The virtual display works as an actual display would work on a printer control panel.

Viewing reports

You can view some reports from the Embedded Web Server. These reports are useful for assessing the status of the printer, network, and supplies.

- 1 Open a Web browser, and then type the printer IP address in the address field.

Notes:

- View the printer IP address on the printer home screen. The IP address appears as four sets of numbers separated by periods, such as 123.123.123.123.
- If you are using a proxy server, then temporarily disable it to load the Web page correctly.

- 2 Click **Reports**, and then click the type of report you want to view.

Copying printer settings to other printers

Note: This feature is available only in network printers.

- 1 Open a Web browser, and then type the printer IP address in the address field.

Notes:

- View the printer IP address in the TCP/IP section in the Network/Ports menu. The IP address appears as four sets of numbers separated by periods, such as 123.123.123.123.
- If you are using a proxy server, then temporarily disable it to load the Web page correctly.

- 2 Click the **Copy Printer Settings**.

- 3 To change the language, select a language from the drop-down menu, and then click **Click here to submit language**.

- 4 Click **Printer Settings**.

- 5 Type the IP addresses of the source and target printers in their appropriate fields.

Note: If you want to add or remove a target printer, then click **Add Target IP** or **Remove Target IP**.

- 6 Click **Copy Printer Settings**.

Configuring supply notifications from the Embedded Web Server

You can determine how you would like to be notified when supplies run nearly low, low, near end-of-life, or reach their end-of-life by setting the selectable alerts.

Note: The percentage of estimated remaining supply that prompts the alert can be set on some supplies for some supply conditions.

- 1 Open a Web browser, and then type the printer IP address.
- 2 Click **Settings > Print Settings > Supply Notifications**.
- 3 From the drop-down menu, select one of the following notification options:

Notification	Description
Off	The normal printer behavior for all supplies occurs.
SNMP Only	The printer generates a Simple Network Management Protocol (SNMP) alert when the supply condition is reached. The status of the supply appears on the menus page and status page.
E-mail	The printer generates an e-mail when the supply condition is reached. The status of the supply appears on the menus page and status page.
Warning	The printer displays the warning message and generates an e-mail about the status of the supply. The printer does not stop when the supply condition is reached.
Continuable Stop ¹	The printer stops processing jobs when the supply condition is reached, and the user needs to press a button to continue printing.
Non Continuable Stop ^{1,2}	The printer stops processing jobs when the supply condition is reached. The supply must be replaced to continue printing.
¹ The printer generates an e-mail about the status of the supply when supply notification is enabled. ² The printer stops when some supplies become empty to prevent damage.	

- 4 Click **Submit**.

Restoring factory default settings

If you want to keep a list of the current menu settings for reference, then print a menu settings page before restoring the factory default settings. For more information, see [“Printing a menu settings page” on page 46](#).

For a more comprehensive method of restoring the printer factory default settings, see [“Erasing non-volatile memory” on page 129](#).

Warning—Potential Damage: Restoring factory defaults returns most printer settings to the original factory default settings. Exceptions include the display language, custom sizes and messages, and network/port menu settings. All downloads stored in the RAM are deleted. Downloads stored in the flash memory or in a printer hard disk are not affected.

- 1 From the home screen, navigate to:



> **Settings > General Settings > Factory Defaults > Restore Now**

- 2 Apply the changes.

Clearing jams

Note: Jam Recovery is set to Auto by default. The printer reprints jammed pages unless the memory required to hold the pages is needed for other printer tasks.

Avoiding jams

Load paper properly

- Make sure paper lies flat in the tray.

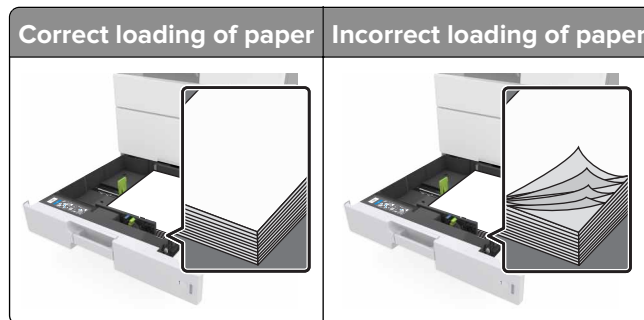

- Do not remove a tray while the printer is printing.
- Do not load a tray while the printer is printing. Load it before printing, or wait for a prompt to load it.
- Do not load too much paper. Make sure the stack height is below the maximum paper fill indicator.
- Do not slide the paper into the tray. Load paper as shown in the illustration.



- Make sure the guides in the tray or the multipurpose feeder are properly positioned and are not pressing tightly against the paper or envelopes.
- Push the tray firmly into the printer after loading paper.

Use recommended paper

- Use only recommended paper or specialty media.
- Do not load wrinkled, creased, damp, bent, or curled paper.

- Flex, fan, and straighten paper before loading it.

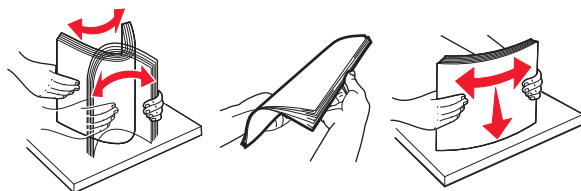

- Do not use paper that has been cut or trimmed by hand.
- Do not mix paper sizes, weights, or types in the same tray.
- Make sure the paper size and type are set correctly on the computer or printer control panel.
- Store paper according to manufacturer recommendations.

Understanding jam messages and locations

When a jam occurs, a message indicating the jam location and information to clear the jam appears on the printer display. Open the doors, covers, and trays indicated on the display to remove the jam.

Notes:

- When Jam Assist is set to On, the printer flushes blank pages or pages with partial prints after a jammed page has been cleared. Check your printed output for blank pages.
- When Jam Recovery is set to On or Auto, the printer reprints jammed pages. However, the Auto setting reprints jammed pages only if adequate printer memory is available.

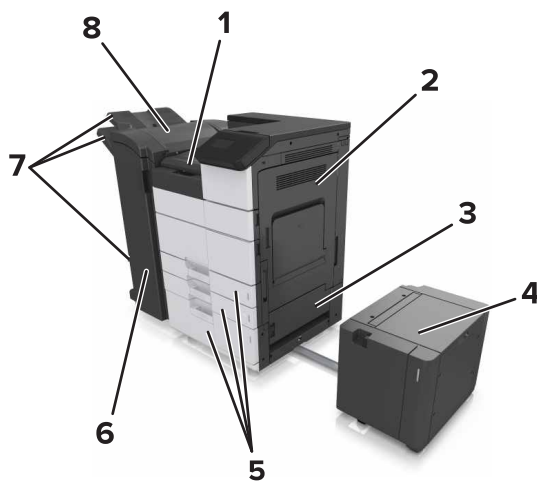

1	Area G
2	Door C
3	Door D
4	Door F
5	Trays
6	Door H
7	Finisher bins

8 Door J

Area name	Control panel message	What to do
Multipurpose feeder	[x]-page jam, clear jammed paper from multipurpose feeder. [200.xx]	Remove the jammed paper from the feeder.
Door C, trays	[x]-page jam, open door C and clear all jammed paper. [2yy.xx]	Open door C, and then remove the jammed paper.
	[x]-page jam, slide the 3000-sheet tray and open door C. [2yy.xx]	Pull out the tray, and then remove the jammed paper.
Door D, trays	[x]-page jam, open door D and clear all jammed paper. [24y.xx]	Open door D, and then remove the jammed paper.
	[x]-page jam, slide the 3000-sheet tray and open door D. [24y.xx]	Pull out the tray, and then remove the jammed paper.
Doors C and F	[x]-page jam, slide the 3000-sheet tray and open door F. [24y.xx]	Pull the 3000-sheet tray, and then remove the jammed paper from the side of the tray. Open door F, and then remove the jammed paper.
Area G, doors C, J, and H, finisher bin	[x]-page jam, open doors G, H, and J and clear jammed paper. [4yy.xx]	Open door G, and then remove the jammed paper. Open door H, and then remove the jammed paper.
Doors C and G, finisher bin	[x]-page jam, press latch to access area G. Leave paper in bin. [40y.xx]	Slide the staple finisher to the left, and then remove the jammed paper.
Area G, doors C, J, and H, finisher bin	[x]-page jam, open door H and rotate knob H6 clockwise. Leave paper in bin. [426.xx–428.xx]	Open door H, and then remove the jammed paper.

[x]-page jam, clear jammed paper from multipurpose feeder. [200.xx]

- 1 Remove all paper from the multipurpose feeder.
- 2 Remove the jammed paper.



3 Open door C to remove any paper fragments.

Note: Make sure that door C does not hit any cable attached to the printer.

4 Close door C.

5 Flex the sheets back and forth to loosen them, and then fan them. Do not fold or crease the paper. Straighten the edges on a level surface.

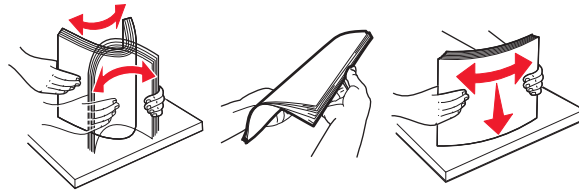

6 Reload the paper.

[x]-page jam, open door C and clear all jammed paper. [2yy.xx]

1 Open door C. Make sure that it does not hit any cable attached to the printer.

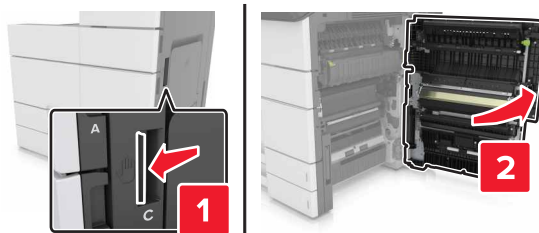

2 Remove the jammed paper from any of the following locations:

Note: Make sure that all paper fragments are removed.

CAUTION—HOT SURFACE: The inside of the printer might be hot. To reduce the risk of injury from a hot component, allow the surface to cool before touching it.

- Fuser area

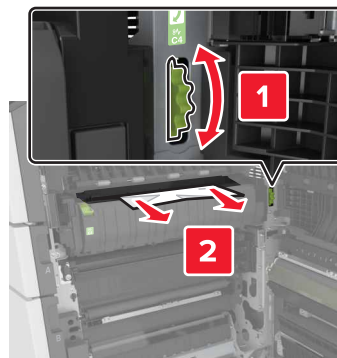

- Below the fuser area

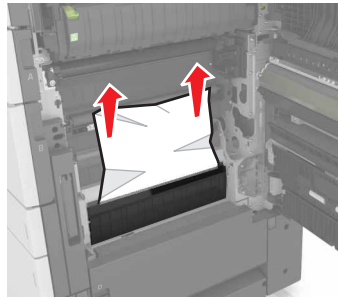

- Duplex area

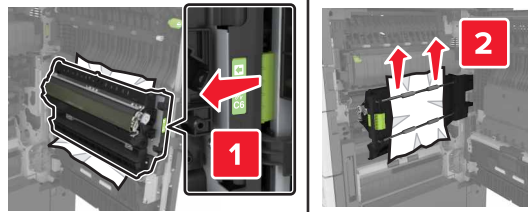

- Above the duplex area

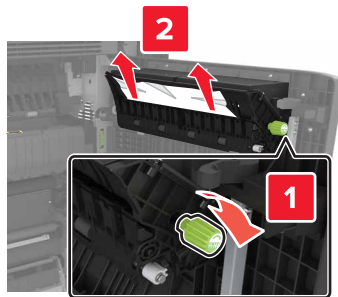

3 Open the standard trays, and then locate the jammed paper.

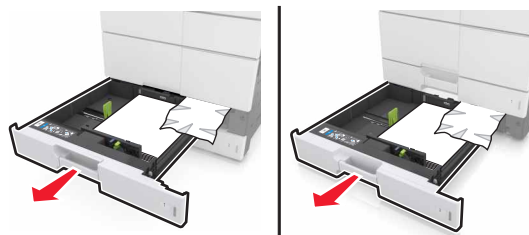

4 Remove the jammed paper.

Note: Make sure that all paper fragments are removed.



5 Close the trays and door C.

[x]-page jam, slide the 3000-sheet tray and open door C. [2yy.xx]

1 Slide the 3000-sheet tray.

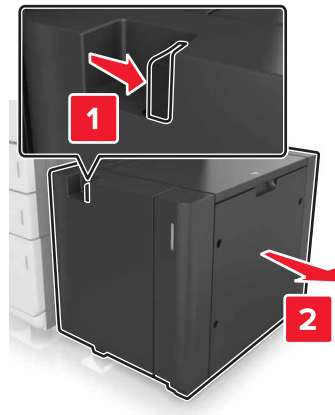

2 Open door C. Make sure that it does not hit any cable attached to the printer.



3 Remove the jammed paper from any of the following locations:

Note: Make sure that all paper fragments are removed.



CAUTION—HOT SURFACE: The inside of the printer might be hot. To reduce the risk of injury from a hot component, allow the surface to cool before touching it.

- Fuser area

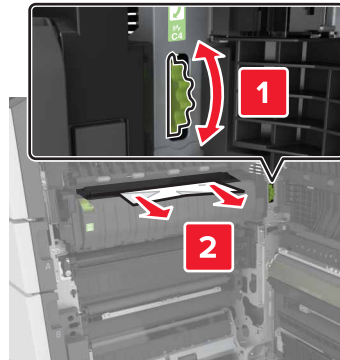

- Below the fuser area

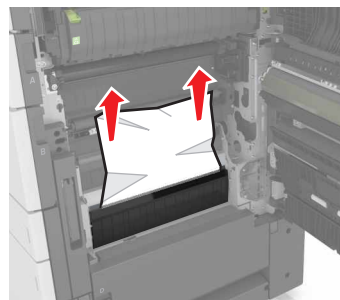

- Duplex area



- Above the duplex area

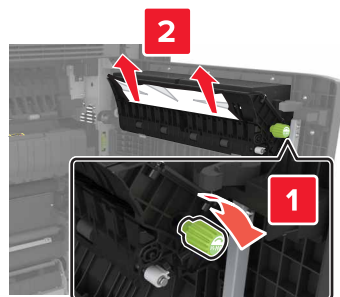

4 Open the standard trays, and then locate the jammed paper.



5 Remove the jammed paper.

Note: Make sure that all paper fragments are removed.



6 Close the trays and door C.

7 Slide the 3000-sheet tray back into place.

[x]-page jam, open door D and clear all jammed paper. [24y.xx]

1 Open door D, and then remove the jammed paper.

Note: Make sure that all paper fragments are removed.

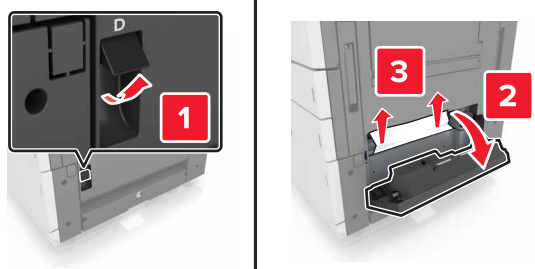

- 2 Open the optional tray, and then locate the jammed paper.

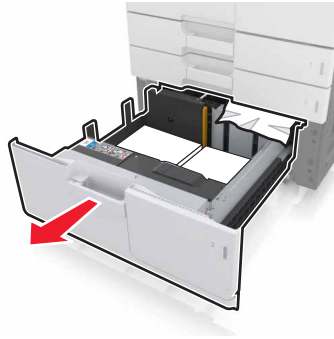

- 3 Remove the jammed paper.

Note: Make sure that all paper fragments are removed.

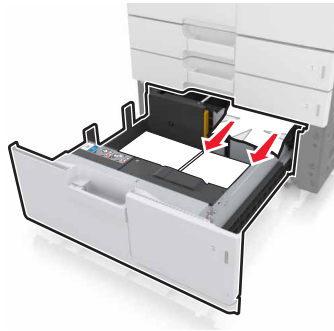

- 4 Close the tray and door D.

[x]-page jam, slide the 3000-sheet tray and open door D. [24y.xx]

- 1 Slide the 3000-sheet tray.

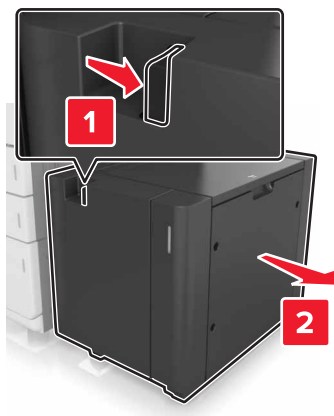

- 2 Open door D, and then remove the jammed paper.

Note: Make sure that all paper fragments are removed.

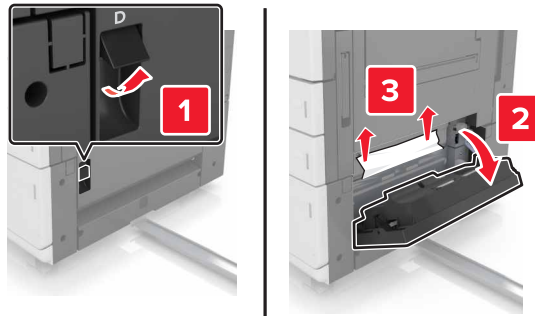

3 Open the optional tray, and then locate the jammed paper.

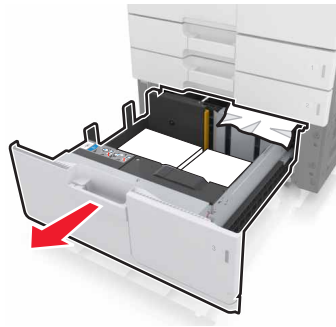

4 Remove the jammed paper.

Note: Make sure that all paper fragments are removed.

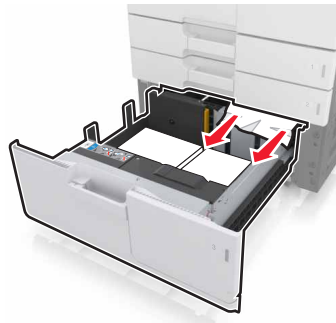

5 Close the tray and door D.

6 Slide the 3000-sheet tray back into place.

[x]-page jam, slide the 3000-sheet tray and open door F. [24y.xx]

- 1 Slide the 3000-sheet tray.

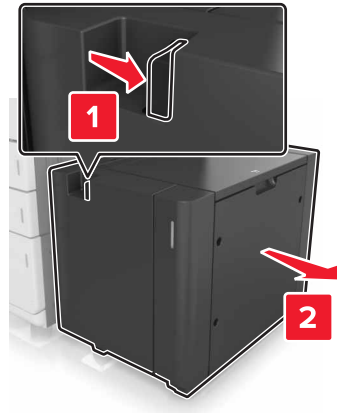

- 2 Remove the jammed paper.

Note: Make sure that all paper fragments are removed.

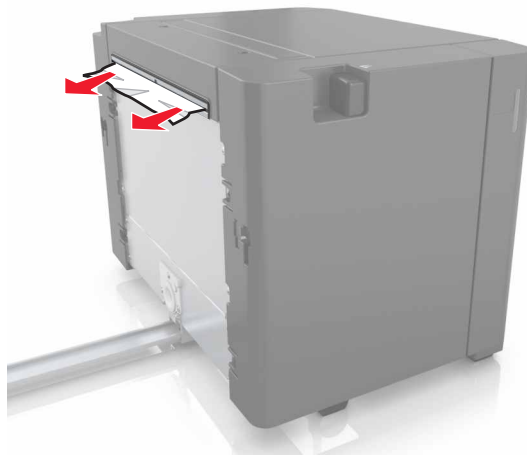

- 3 Open door F, and then remove the jammed paper.

Note: Make sure that all paper fragments are removed.

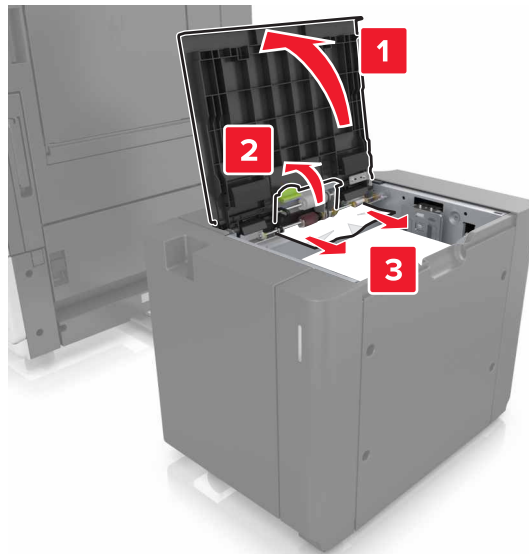

4 Close door F.

5 Open door C. Make sure that it does not hit any cable attached to the printer.



6 Remove the jammed paper from any of the following locations:

Note: Make sure that all paper fragments are removed.

 **CAUTION—HOT SURFACE:** The inside of the printer might be hot. To reduce the risk of injury from a hot component, allow the surface to cool before touching it.

- Fuser area

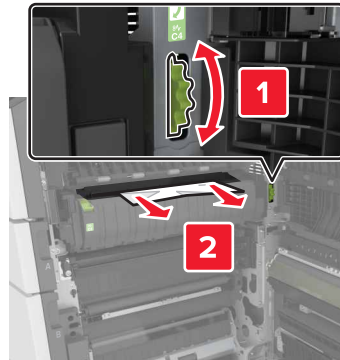

- Below the fuser area

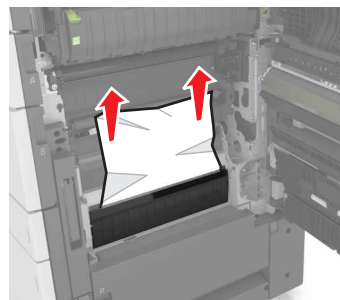

- Duplex area



- Above the duplex area

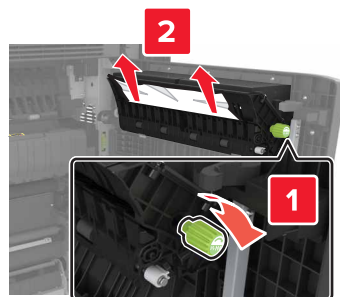

7 Close door C, and then slide the 3000-sheet tray back into place.

[x]-page jam, open doors G, H, and J and clear jammed paper. Leave paper in bin. [4yy.xx]

- 1 Open door G, and then remove the jammed paper.

Note: Make sure that all paper fragments are removed.

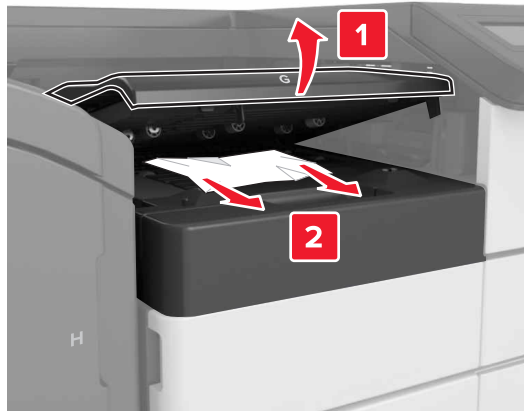

- 2 Open door J, and then lift handle J1 to its upright position.

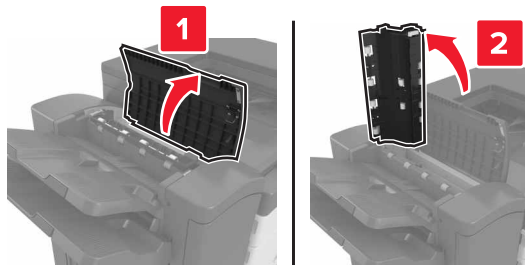

- 3 Open door H.

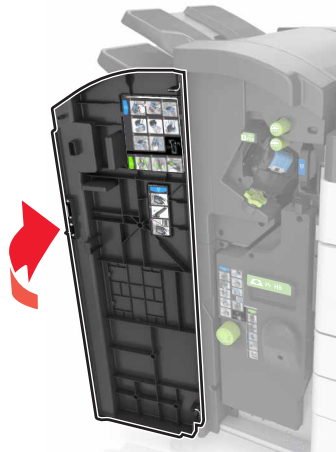

- 4 Remove the jammed paper from any of the following locations:

Note: Make sure that all paper fragments are removed.

- Door J

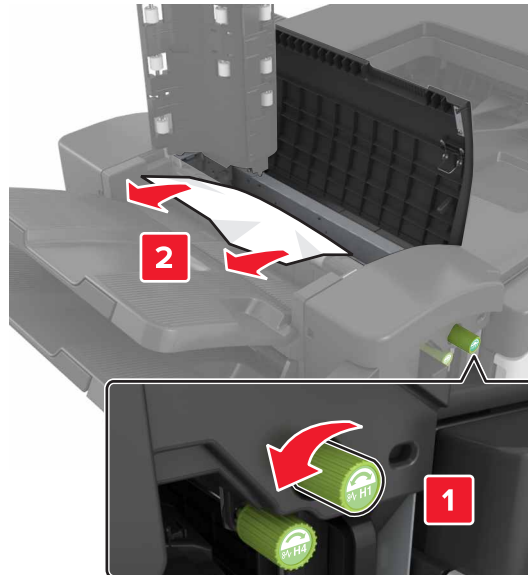

Note: If there is a jammed paper between the finisher bins, then remove the paper.

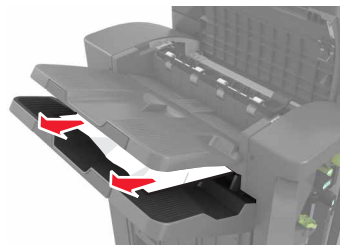

- Areas H1 and H2



- Areas H3 and H4

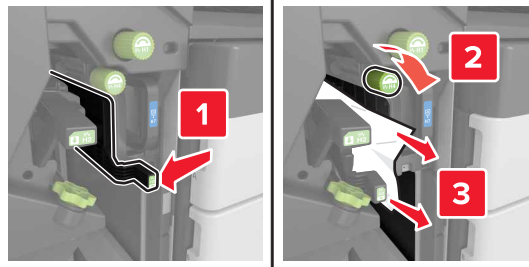

- Area H6

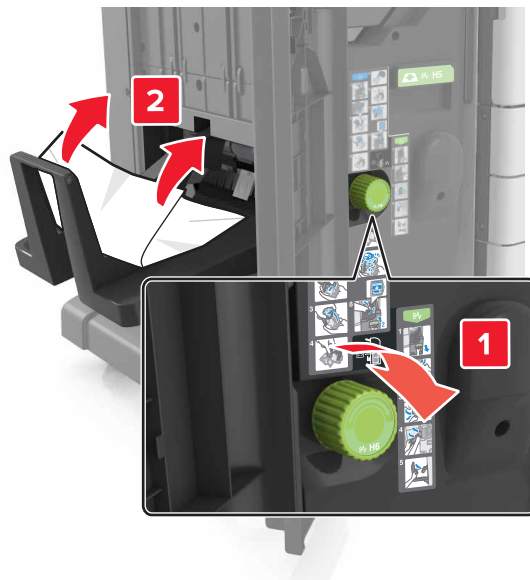

5 Close Door H.

6 Open door C, and then remove the jammed paper.

Note: Make sure that door C does not hit any cable attached to the printer.

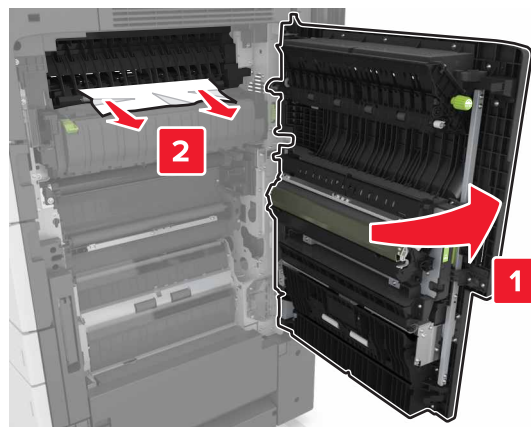

Notes:

- Make sure that all paper fragments are removed.
- If the 3000-sheet tray is installed, then slide the tray to the right to open the door.

7 Close door C.

[x]-page jam, press latch to access area G. Leave paper in bin. [40y.xx]

1 Remove all paper from the staple finisher bin.

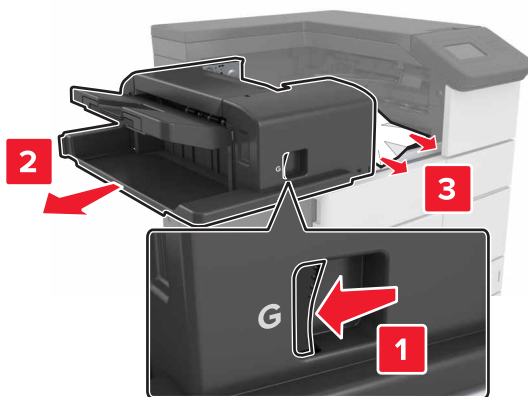

2 Press the latch and slide the staple finisher to the left, and then remove the jammed paper.

**Notes:**

- Make sure that all paper fragments are removed.
- If necessary, turn spinner wheel G1 downward to feed jammed paper into the finisher bin, and then remove the paper.



3 Slide the finisher back into place.

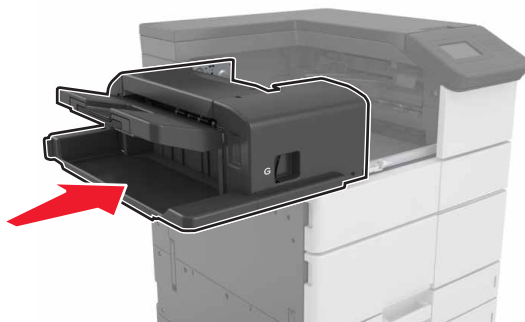

4 Open door C, and then remove the jammed paper.

CAUTION—HOT SURFACE: The inside of the printer might be hot. To reduce the risk of injury from a hot component, allow the surface to cool before touching it.

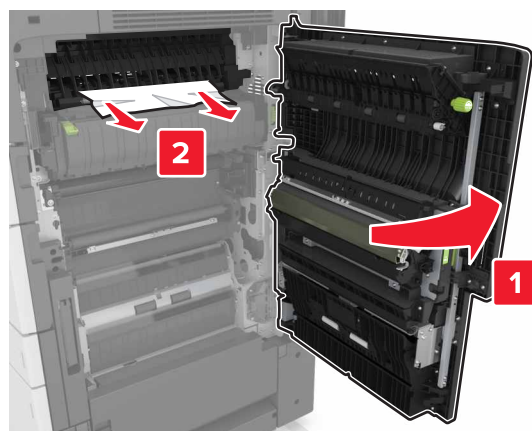

Notes:

- Make sure that door C does not hit any cable attached to the printer.
- Make sure that all paper fragments are removed.

- If the 3000-sheet tray is installed, then slide the tray to the right to open the door.

5 Close door C.

[x]-page jam, press latch to access area G and clear jammed staples. Leave paper in bin. [402.93]

1 Remove all paper from the staple finisher bin.

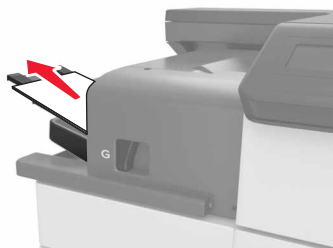

2 Press the latch on the staple finisher, and then slide the finisher to the left.

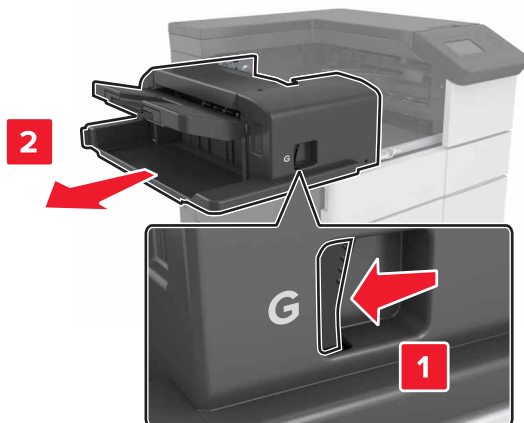

3 Remove the staple cartridge holder.



- 4 Use the metal tab to lift the staple guard, and then remove any loose staples.

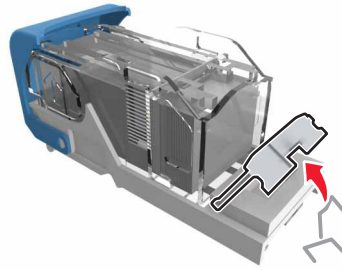

- 5 Press the staple guard down until it *clicks* into place.

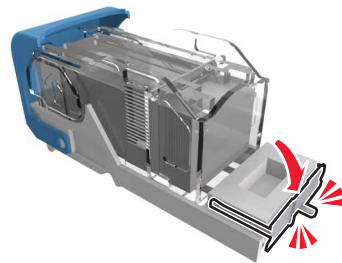

- 6 Press the staples against the metal bracket.



Note: If the staples are at the rear of the cartridge, then shake the cartridge downward to bring the staples near the metal bracket.

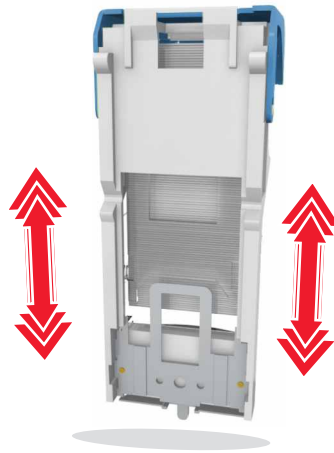

7 Push the cartridge holder into the finisher until the holder *clicks* into place.

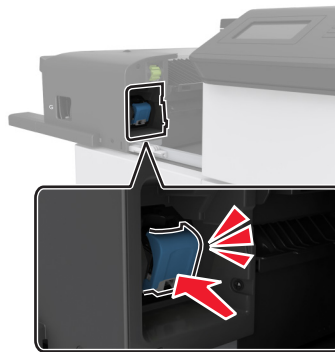

8 Slide the finisher back into place.

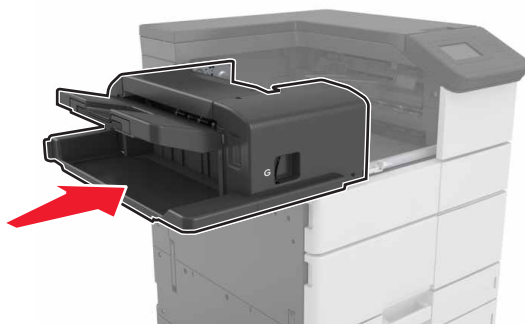

**[x]-page jam, open door H and rotate knob H6 clockwise.
Leave paper in bin. [426.xx–428.xx]**

If the jammed paper is located under door G, then open the door and remove the paper.

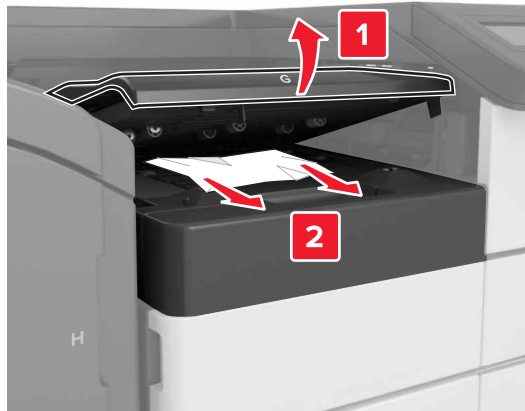

1 Open door J, and then lift handle J1.

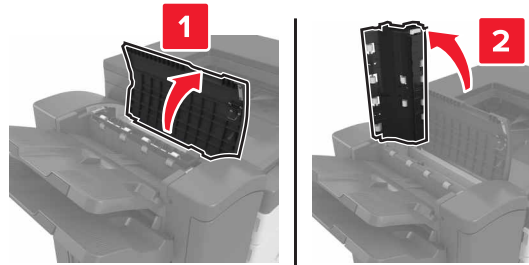

2 Open door H.



3 Remove the jammed paper from any of the following locations:

Note: Make sure that all paper fragments are removed.

- Door J

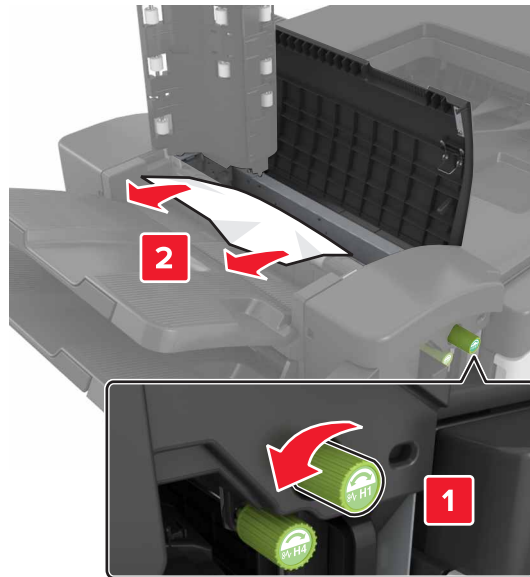

Note: If there is a jammed paper between the finisher bins, then remove the paper.

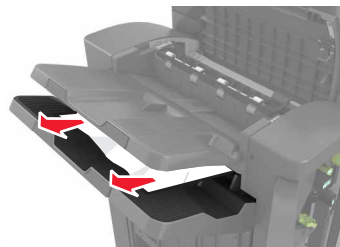

- Areas H1 and H2



- Areas H3 and H4

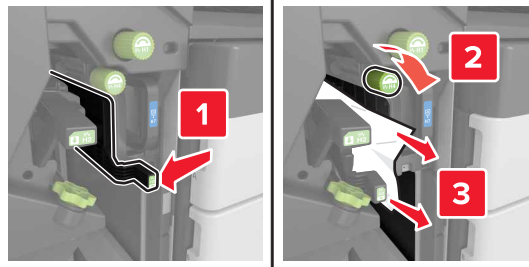

- Area H6

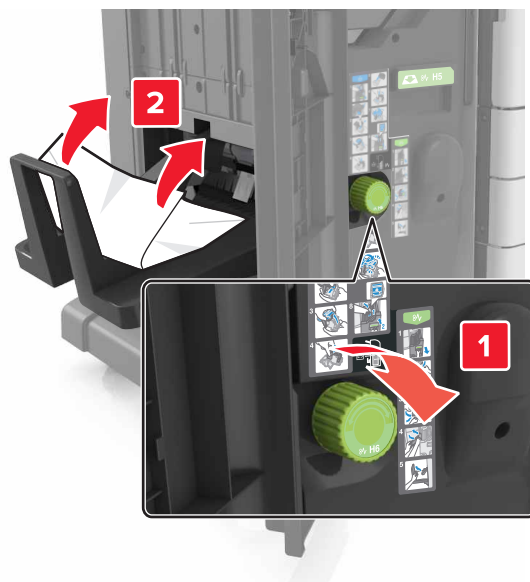

4 Using handle H5, pull out the booklet maker.

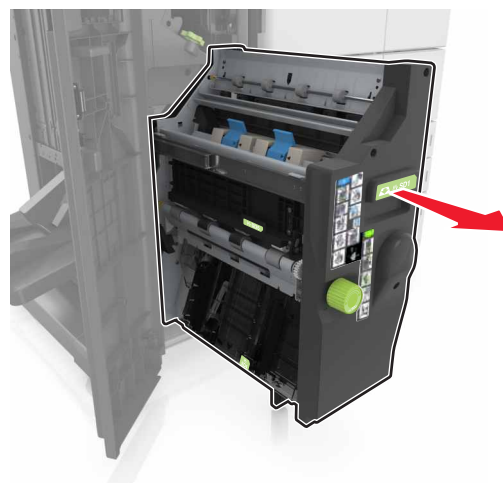

5 Remove the jammed paper from any of the following locations:

Note: Make sure that all paper fragments are removed.

- Area H8

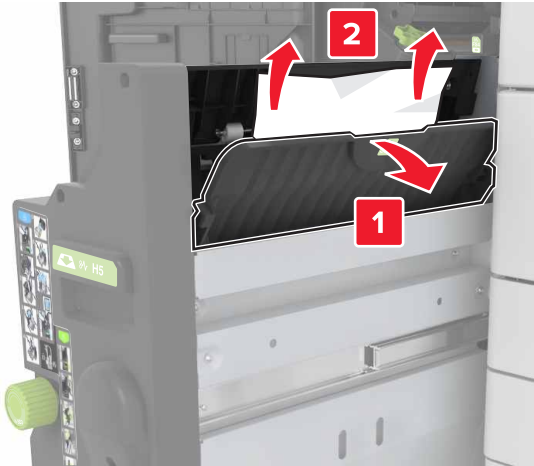

- Area H9

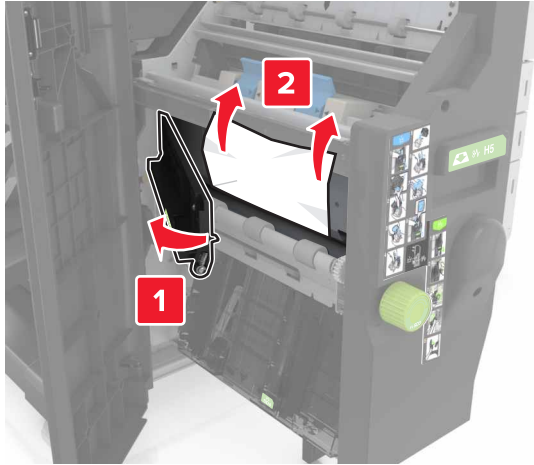

- Area H10

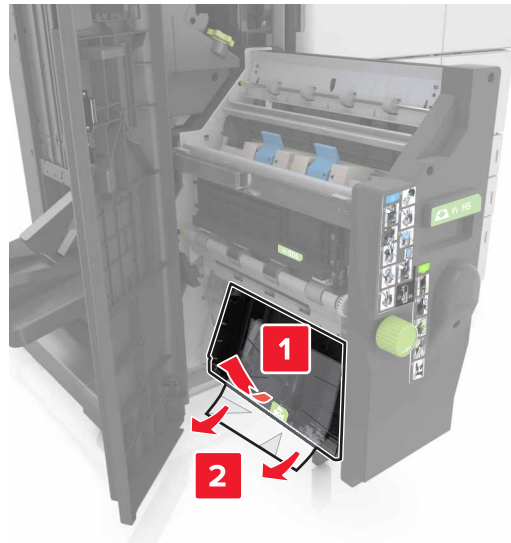

- 6 Push the booklet maker back into place.
- 7 Close door H.
- 8 Open door C, and then remove the jammed paper.

 **CAUTION—HOT SURFACE:** The inside of the printer might be hot. To reduce the risk of injury from a hot component, allow the surface to cool before touching it.

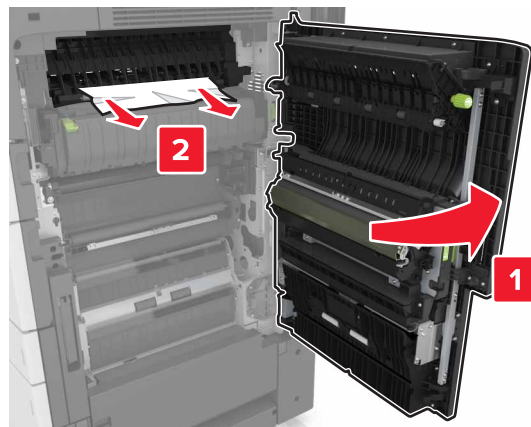

Notes:

- Make sure that door C does not hit any cable attached to the printer.
- Make sure that all paper fragments are removed.
- If the 3000-sheet tray is installed, then slide the tray to the right to open the door.

- 9 Close door C.

Troubleshooting

Understanding the printer messages

Cartridge low [88.xy]

You may need to order a replacement toner cartridge. If necessary, touch **Continue** on the printer control panel to clear the message and continue printing.

Cartridge nearly low [88.xy]

If necessary, touch **Continue** on the printer control panel to clear the message and continue printing.

Cartridge very low [88.xy]

You may need to replace the toner cartridge very soon. For more information, see [“Replacing the toner cartridge” on page 147](#).

If necessary, touch **Continue** on the control panel to clear the message and continue printing.

Change [paper source] to [custom string] load [orientation]

Try one or more of the following:

- Load the correct size and type of paper in the tray, specify the paper size and type in the Paper menu on the control panel, and then touch **Finished changing paper**.
- Touch **Use current [paper source]** to use the available paper size and type in the tray.
- Touch **Reset active bin** to reset the active bin for a linked set of bins.
- Cancel the print job.

Change [paper source] to [custom type name] load [orientation]

Try one or more of the following:

- Load the correct size and type of paper in the tray or feeder, specify the paper size and type in the Paper menu on the printer control panel, and then touch **Finished changing paper**.
- Touch **Reset active bin** to reset the active bin for a linked set of bins.
- Cancel the print job.

Change [paper source] to [paper size] load [orientation]

Try one or more of the following:

- Load the correct size and type of paper in the tray or feeder, specify the size and type of paper in the Paper menu on the control panel, and then touch **Finished changing paper**.
- Touch **Use current [paper source]** to use the available size and type of paper in the current tray or feeder.

- Touch **Reset active bin** to reset the active bin for a linked set of bins.
- Cancel the print job.

Change [paper source] to [paper type] [paper size] load [orientation]

Try one or more of the following:

- Load the correct size and type of paper in the tray or feeder, specify the paper size and type in the Paper menu on the control panel, and then touch **Finished changing paper**.
- Touch **Use current [paper source]** to use the available paper size and type in the tray.
- Touch **Reset active bin** to reset the active bin for a linked set of bins.
- Cancel the print job.

Close door [x]

Close the specified door.

Complex page, some data may not have printed [39]

Try one or more of the following:

- From the control panel, touch **Continue** to clear the message and continue printing.
- Touch **Reset active bin** to reset the active bin for a linked set of bins.
- Cancel the print job.
- Install additional printer memory.

Configuration change, some held jobs were not restored [57]

Held jobs are invalidated because of the following possible changes in the printer:

- The printer firmware has been updated.
- The tray for the print job has been removed.
- The print job is sent from a flash drive that is no longer attached to the USB port.
- The printer hard disk contains print jobs that were stored when the hard disk was installed in a different printer model.

From the printer control panel, touch **Continue** to clear the message.

Defective flash detected [51]

Try one or more of the following:

- Replace the defective flash memory card.
- From the printer control panel, touch **Continue** to ignore the message and continue printing.
- Cancel the current print job.

Disk full [62]

Try one or more of the following:

- From the control panel, touch **Continue** to clear the message and continue printing.
- Touch **Reset active bin** to reset the active bin for a linked set of bins.
- Delete fonts, macros, and other data stored in the printer hard disk.
- Install a hard disk with larger capacity.

Disk must be formatted for use in this device

From the printer control panel, touch **Format disk** to format the printer hard disk and clear the message.

Note: Formatting deletes all the files stored in the printer hard disk.

Disk near full. Securely clearing disk space.

Try one or more of the following:

- Touch **Continue** to clear the message and continue printing.
- Delete fonts, macros, and other data stored on the printer hard disk.
- Install a hard disk with higher capacity.

Empty the hole punch box

Try one or more of the following:

- Empty the hole punch box.
- Select **Continue** on the printer control panel to clear the message and continue printing.
- Cancel the print job.

Error reading USB drive. Remove USB.

An unsupported USB device is inserted. Remove the USB device, and then insert a supported one.

Error reading USB hub. Remove hub.

An unsupported USB hub has been inserted. Remove the USB hub, and then install a supported one.

Incorrect paper size, open [paper source] [34]

Try one or more of the following:

- Load the correct paper size and type in the tray or feeder, and then specify the paper size and type in the Paper menu on the control panel.
- Make sure that the correct paper size and type are specified in Print Properties or the Print dialog settings.
- Check the length and width guides and make sure that the paper is loaded properly in the tray or feeder.
- From the control panel, touch **Continue** to clear the message and then print using a different tray.

- Touch **Reset active bin** to reset the active bin for a linked set of bins.
- Cancel the print job.

Insert hole punch box

Insert the hole punch box into the finisher, and then touch **Continue** to clear the message.

Insert Tray [x]

Try one or more of the following:

- Insert the specified tray into the printer.
- Cancel the print job.
- Reset the active bin for a linked set of bins by selecting **Reset active bin** on the printer control panel.

Insufficient memory for Flash Memory Defragment operation [37]

Try one or more of the following:

- From the printer control panel, touch **Continue** to stop the defragmentation and continue printing.
- Delete fonts, macros, and other data in the printer memory.
- Install additional printer memory.

Insufficient memory to collate job [37]

Try one or more of the following:

- From the printer control panel, touch **Continue** to print the part of the job already stored and begin collating the rest of the print job.
- Cancel the current print job.

Insufficient memory to support Resource Save feature [35]

Install additional printer memory or touch **Continue** to disable Resource Save, clear the message, and continue printing.

Insufficient memory, some Held Jobs were deleted [37]

From the printer control panel, touch **Continue** to clear the message.

Insufficient memory, some held jobs will not be restored [37]

Try one or more of the following:

- From the printer control panel, touch **Continue** to clear the message.
- Delete other held jobs to free up additional printer memory.

Insufficient space between paper stacks in Tray 3

Move the paper stacks apart, and then touch **Continue** on the control panel to clear the message and continue printing.

Load [paper source] with [custom string] [paper orientation]

Try one or more of the following:

- Load the tray or feeder with the correct size and type of paper, and then touch **Finished loading paper** on the control panel.
- Touch **Reset active bin** to reset the active bin for a linked set of bins.
- Cancel the current job.

Load [paper source] with [custom type name] [paper orientation]

Try one or more of the following:

- Load the tray or feeder with the correct size and type of paper, and then touch **Finished loading paper** on the control panel.
- Touch **Reset active bin** to reset the active bin for a linked set of bins.
- Cancel the print job.

Load [paper source] with [paper size] [paper orientation]

Try one or more of the following:

- Load the tray or feeder with the correct size of paper, and then touch **Finished loading paper** on the control panel.
- Touch **Reset active bin** to reset the active bin for a linked set of bins.
- Cancel the current job.

Load [paper source] with [paper type] [paper size] [paper orientation]

Try one or more of the following:

- Load the specified tray or feeder with the correct size and type of paper, and then touch **Finished loading paper** on the control panel.
- Touch **Reset active bin** to reset the active bin for a linked set of bins.
- Cancel the current job.

Load Multipurpose Feeder with [custom string] [paper orientation]

Try one or more of the following:

- Load the feeder with the correct size and type of paper.
- From the control panel, touch one of the following:
 - **Prompt each page, paper loaded** or **Do not prompt, paper loaded**—To clear the message and continue printing.
 - **Automatically select paper**—To use the paper loaded in the tray.

- **Reset active bin**—To reset the active bin for a linked set of bins.
- Cancel the print job.

Load Multipurpose Feeder with [custom type name] [paper orientation]

Try one or more of the following:

- Load the feeder with the correct size and type of paper.
- From the control panel, touch one of the following:
 - **Prompt each page, paper loaded** or **Do not prompt, paper loaded**—To clear the message and continue printing.
 - **Automatically select paper**—To use the paper loaded in the tray.
 - **Reset active bin**—To reset the active bin for a linked set of bins.
- Cancel the print job.

Load Multipurpose Feeder with [paper size] [paper orientation]

Try one or more of the following:

- Load the feeder with the correct size of paper.
- From the control panel, touch one of the following:
 - **Prompt each page, paper loaded** or **Do not prompt, paper loaded**—To clear the message and continue printing.
 - **Automatically select paper**—To use the paper loaded in the tray.
 - **Reset active bin**—To reset the active bin for a linked set of bins.
- Cancel the print job.

Load Multipurpose Feeder with [paper type] [paper size] [paper orientation]

Try one or more of the following:

- Load the feeder with the correct size and type of paper.
- From the control panel, touch one of the following:
 - **Prompt each page, paper loaded** or **Do not prompt, paper loaded**—To clear the message and continue printing.
 - **Automatically select paper**—To use the paper loaded in the tray.
 - **Reset active bin**—To reset the active bin for a linked set of bins.
- Cancel the print job.

Load staples

Try one or more of the following:

- Replace or insert the staple cartridge in the finisher.
For instructions on inserting or replacing a staple cartridge in the finisher, touch **More information** on the printer control panel.
- From the printer control panel, touch **Continue** to clear the message and continue printing.

- From the printer control panel, touch **Cancel job** to cancel the print job.

Load staples [G11, G12]

Try one or more of the following:

- Replace or insert the staple cartridge into the finisher.
For instructions on replacing or inserting the staple cartridge into the finisher, touch **More information** on the control panel.
- From the control panel, touch **Continue** to clear the message and continue printing.
- Cancel the print job.

[x] maintenance kit very low [80.xy]

You may need to replace the maintenance kit very soon. For more information, go to the Lexmark support Web site at <http://support.lexmark.com> or contact customer support, and then report the message.

If necessary, touch **Continue** to clear the message and continue printing.

Memory full [38]

Try one or more of the following:

- From the control panel, touch **Cancel job** to clear the message.
- Touch **Reset active bin** to reset the active bin for a linked set of bins.
- Install additional printer memory.

Network [x] software error [54]

Try one or more of the following:

- From the printer control panel, touch **Continue** to continue printing.
- Turn off the printer, wait for about 10 seconds, and then turn the printer back on.
- Update the network firmware in the printer or print server. For more information, visit the Lexmark support Web site at <http://support.lexmark.com>.

Not enough free space in flash memory for resources [52]

Try one or more of the following:

- From the control panel, touch **Continue** to clear the message and continue printing.
- Touch **Reset active bin** to reset the active bin for a linked set of bins.
- Delete fonts, macros, and other data stored in the flash memory.
- Install a flash memory card with larger capacity.

Note: Downloaded fonts and macros not previously stored in the flash memory are deleted.

Open door H and remove paper from beneath area H10

Remove the paper from the specified area.

Paper changes needed

Try one or more of the following:

- Touch **Use current supplies** to clear the message and continue printing.
- Cancel the current print job.

Parallel port [x] disabled [56]

Try one or more of the following:

- From the printer control panel, touch **Continue** to clear the message.
- Enable the parallel port. From the printer control panel, navigate to:
Network/Ports > Parallel [x] > Parallel Buffer > Auto

Note: The printer discards any data received through the parallel port.

Photoconductor low [84.xy]

You may need to order a replacement photoconductor. If necessary, select **Continue** on the control panel to clear the message and continue printing.

Photoconductor very low [84.xy]

You may need to replace the photoconductor unit very soon. For more information, see [“Replacing a photoconductor unit” on page 140](#).

If necessary, touch **Continue** on the control panel to clear the message and continue printing.

Printer had to restart. Last job may be incomplete.

From the printer control panel, touch **Continue** to clear the message and continue printing.

For more information, visit <http://support.lexmark.com> or contact customer support.

Reinstall missing or unresponsive cartridge [31.xy]

Try one or more of the following:

- Check if the toner cartridge is missing. If missing, install the toner cartridge.
For information on installing the cartridge, see the “Replacing supplies” section of the *User’s Guide*.
- If the toner cartridge is installed, then remove the unresponsive toner cartridge, and then reinstall it.

Note: If the message appears after reinstalling the supply, then the cartridge is defective. Replace the toner cartridge.

Reinstall missing or unresponsive photoconductor [31.xy]

Try one or more of the following:

- If the photoconductor unit is missing, then install it. For more information, see [“Replacing a photoconductor unit” on page 140](#).
- If the photoconductor unit is installed, then remove and then reinstall it.

Note: If the message appears after reinstalling the supply, then replace the defective photoconductor unit.

Remove defective disk [61]

Remove and replace the defective printer hard disk.

Remove packaging material, [area name]

Remove any remaining packaging material from the specified location.

Remove packaging material, open door C, remove metal clips

Open door C, and then remove any remaining packaging material.

Note: Make sure that door C does not hit any cable attached to the printer.

Remove paper from all bins

Remove the paper from all of the bins. The printer automatically senses paper removal and resumes printing.

If removing the paper does not clear the message, then touch **Continue**.

Remove paper from bin [x]

Remove the paper from the specified bin. The printer automatically senses paper removal and resumes printing.

If removing the paper does not clear the message, then touch **Continue**.

Remove paper from [linked set bin name]

Remove paper from the specified bin. The printer automatically detects paper removal and resumes printing.

If removing the paper does not clear the message, then touch **Continue**.

Remove paper from standard output bin

Remove the paper stack from the standard bin.

Replace cartridge, 0 estimated pages remain [88.xy]

Replace the toner cartridge to clear the message and continue printing. For more information, see the instruction sheet that came with the supply or see the “Replacing supplies” section of the *User’s Guide*.

Note: If you do not have a replacement cartridge, then see the “Ordering supplies” section of the *User’s Guide* or visit www.lexmark.com.

Replace cartridge, printer region mismatch [42.xy]

Install a toner cartridge that matches the region number of the printer. x indicates the value of the printer region. y indicates the value of the cartridge region. x and y can have the following values:

Printer and toner cartridge regions

Region number	Region
0	Global
1	United States, Canada
2	European Economic Area (EEA), Switzerland
3	Asia Pacific, Australia, New Zealand
4	Latin America
5	Africa, Middle East, rest of Europe
9	Invalid

Notes:

- The x and y values represent .xy in the code that appears on the printer control panel.
- The x and y values must match for printing to continue.

Replace [x] maintenance kit, 0 estimated pages remain [80.xy]

The printer is scheduled for maintenance. For more information, go to the Lexmark support Web site at <http://support.lexmark.com> or contact your service representative, and then report the message.

Replace missing photoconductor [31.xy]

Install the missing photoconductor unit to clear the message. For more information, see [“Replacing a photoconductor unit” on page 140](#).

Replace missing waste toner bottle [82.xy]

Install the missing waste toner bottle to clear the message. For more information, see the instruction sheet that came with the supply.

Replace missing cartridge [31.xy]

Install the missing cartridge to clear the message. For more information, see [“Replacing the toner cartridge” on page 147](#).

Replace paper pick rollers in [paper source], use parts and instructions in tray 1 or tray 2 compartment [80]

Try one or more of the following:

- Replace the pick rollers, and then touch **Rollers replaced** on the control panel to clear the message and continue printing.
- Touch **Replace later (jams may persist)** to ignore the message and continue printing.

Replace photoconductor, 0 pages remain [84.xy]

Replace the photoconductor unit to clear the message and continue printing. For more information, see the instruction sheet that came with the supply or see [“Replacing a photoconductor unit” on page 140](#).

Note: If you do not have a replacement photoconductor unit, then see [“Ordering supplies” on page 138](#) or go to www.lexmark.com.

Replace unsupported cartridge [32.xy]

Remove the toner cartridge, and then install a supported one to clear the message and continue printing. For more information, see the instruction sheet that came with the supply or see the “Replacing supplies” section of the *User’s Guide*.

Note: If you do not have a replacement cartridge, then see the “Ordering supplies” section of the *User’s Guide* or visit www.lexmark.com.

Replace unsupported photoconductor [32.xy]

Remove the photoconductor unit, and then install a supported one to clear the message and continue printing. For more information, see the instruction sheet that came with the supply or see [“Replacing a photoconductor unit” on page 140](#).

Note: If you do not have a replacement photoconductor unit, then see [“Ordering supplies” on page 138](#) or go to www.lexmark.com.

Replace waste toner bottle [82.xy]

Replace the waste toner bottle to clear the message.

Restore held jobs?

Try one or more of the following:

- From the printer control panel, touch **Restore** to restore all held jobs stored in the printer hard disk.
- From the printer control panel, touch **Do not restore** if you do not want to restore any of the print jobs.

Serial port [x] disabled [56]

Try one or more of the following:

- From the printer control panel, touch **Continue** to clear the message.
The printer discards any data received through the specified serial port.
- Make sure Serial Buffer is not set to Disabled.
- From the printer control panel, set Serial Buffer to Auto in the Serial [x] menu.

Some held jobs were not restored

From the printer control panel, touch **Continue** to delete the indicated job.

Note: Held jobs that are not restored remain in the printer hard disk and are inaccessible.

SMTP server not set up. Contact system administrator.

From the printer control panel, touch **Continue** to clear the message.

Note: If the message appears again, then contact your system support person.

Standard network software error [54]

Try one or more of the following:

- From the printer control panel, touch **Continue** to continue printing.
- Turn off the printer, and then turn it back on.
- Update the network firmware in the printer or print server. For more information, visit the Lexmark support Web site at <http://support.lexmark.com> or contact customer support, and then report the message.

Standard USB port disabled [56]

Try one or more of the following:

- From the printer control panel, touch **Continue** to clear the message.
- Enable the USB port. From the printer control panel, navigate to:
Network/Ports > USB Buffer > Auto

Note: The printer discards any data received through the USB port.

Supply needed to complete job

Do either of the following:

- Install the missing supply to complete the job.
- Cancel the current job.

The device is operating in Safe Mode. Some print options may be disabled or provide unexpected results.

Touch **Continue** on the control panel to clear the message and continue printing.

Too many flash options installed [58]

Try one or more of the following:

- Touch **Continue** on the control panel to continue printing.
- Remove the extra flash memory:
 - 1 Turn off the printer.
 - 2 Unplug the power cord from the electrical outlet.
 - 3 Remove the extra flash memory.
 - 4 Connect the power cord to a properly grounded electrical outlet.
 - 5 Turn the printer back on.

Too many trays attached [58]

- 1 Turn off the printer.
- 2 Unplug the power cord from the electrical outlet.
- 3 Remove the extra trays.
- 4 Connect the power cord to a properly grounded electrical outlet.
- 5 Turn the printer back on.

Tray [x] paper size unsupported

Replace with a supported paper size.

Unformatted flash detected [53]

Try one or more of the following:

- From the printer control panel, touch **Continue** to stop the defragmentation and continue printing.
- Format the flash memory.

Note: If the error message remains, then the flash memory may be defective and needs to be replaced.

Unsupported disk

Remove the unsupported printer hard disk, and then insert a supported one.

Unsupported option in slot [x] [55]

- 1 Turn off the printer.
- 2 Unplug the power cord from the electrical outlet.
- 3 Remove the unsupported option card from the printer controller board, and then replace it with a supported card.
- 4 Connect the power cord to a properly grounded electrical outlet.
- 5 Turn the printer back on.

Waste toner bottle nearly full [82.xy]

You may need to order a waste toner bottle. If necessary, touch **Continue** on the printer control panel to clear the message and continue printing.

Weblink server not set up. Contact system administrator.

From the printer control panel, touch **Continue** to clear the message.

Note: If the message appears again, then contact your system support person.

Solving printer problems

Basic printer problems

The printer is not responding

Action	Yes	No
<p>Step 1 Make sure the printer is turned on.</p> <p>Is the printer turned on?</p>	Go to step 2.	Turn on the printer.
<p>Step 2 Check if the printer is in Sleep mode or Hibernate mode.</p> <p>Is the printer in Sleep mode or Hibernate mode?</p>	Press the Sleep button to wake the printer from Sleep mode or Hibernate mode.	Go to step 3.
<p>Step 3 Check if one end of the power cord is plugged into the printer and the other to a properly grounded electrical outlet.</p> <p>Is the power cord plugged into the printer and a properly grounded electrical outlet?</p>	Go to step 4.	Plug one end of the power cord into the printer and the other to a properly grounded electrical outlet.

Action	Yes	No
<p>Step 4 Check other electrical equipment plugged into the electrical outlet.</p> <p>Does other electrical equipment work?</p>	<p>Unplug the other electrical equipment, and then turn on the printer. If the printer does not work, then reconnect the other electrical equipment.</p>	<p>Go to step 5.</p>
<p>Step 5 Check if the cables connecting the printer and the computer are inserted in the correct ports.</p> <p>Are the cables inserted in the correct ports?</p>	<p>Go to step 6.</p>	<p>Make sure to match the following:</p> <ul style="list-style-type: none"> • The USB symbol on the cable with the USB symbol on the printer • The appropriate Ethernet cable with the Ethernet port
<p>Step 6 Make sure the electrical outlet is not turned off by a switch or breaker.</p> <p>Is the electrical outlet turned off by a switch or breaker?</p>	<p>Turn on the switch or reset the breaker.</p>	<p>Go to step 7.</p>
<p>Step 7 Check if the printer is plugged into any surge protectors, uninterruptible power supplies, or extension cords.</p> <p>Is the printer plugged into any surge protectors, uninterruptible power supplies, or extension cords?</p>	<p>Connect the printer power cord directly to a properly grounded electrical outlet.</p>	<p>Go to step 8.</p>
<p>Step 8 Check if one end of the printer cable is plugged into a port on the printer and the other to the computer, print server, option, or other network device.</p> <p>Is the printer cable securely attached to the printer and the computer, print server, option, or other network device?</p>	<p>Go to step 9.</p>	<p>Connect the printer cable securely to the printer and the computer, print server, option, or other network device.</p>
<p>Step 9 Make sure to install all hardware options properly and remove any packing material.</p> <p>Are all hardware options properly installed and all packing material removed?</p>	<p>Go to step 10.</p>	<p>Turn off the printer, remove all packing materials, then reinstall the hardware options, and then turn on the printer.</p>
<p>Step 10 Check if you have selected the correct port settings in the printer driver.</p> <p>Are the port settings correct?</p>	<p>Go to step 11.</p>	<p>Use correct printer driver settings.</p>

Action	Yes	No
<p>Step 11 Check the installed printer driver.</p> <p>Is the correct printer driver installed?</p>	Go to step 12.	Install the correct printer driver.
<p>Step 12 Turn off the printer, then wait for about 10 seconds, and then turn the printer back on.</p> <p>Is the printer working?</p>	The problem is solved.	Contact customer support .

Printer display is blank

Action	Yes	No
<p>Step 1 Press the Sleep button on the printer control panel.</p> <p>Does Ready appear on the printer display?</p>	The problem is solved.	Go to step 2.
<p>Step 2 Turn off the printer, then wait for about 10 seconds, and then turn the printer back on.</p> <p>Do Please wait and Ready appear on the printer display?</p>	The problem is solved.	Turn off the printer, and then contact customer support .

Hardware and internal option problems

Cannot detect internal option

Action	Yes	No
<p>Step 1 Turn off the printer, then wait for about 10 seconds, and then turn on the printer.</p> <p>Does the internal option operate correctly?</p>	The problem is solved.	Go to step 2.
<p>Step 2 Check if the internal option is properly installed in the controller board.</p> <ul style="list-style-type: none"> a Turn off the printer using the power switch, and then unplug the power cord from the electrical outlet. b Make sure the internal option is installed in the appropriate connector in the controller board. c Connect the power cord to the printer, then to a properly grounded electrical outlet, and then turn on the printer. <p>Is the internal option properly installed in the controller board?</p>	Go to step 3.	Connect the internal option to the controller board.

Action	Yes	No
<p>Step 3</p> <p>Print a menu settings page, and then check to see if the internal option is listed in the Installed Features list.</p> <p>Is the internal option listed in the menu settings page?</p>	Go to step 4.	Reinstall the internal option.
<p>Step 4</p> <p>a Check if the internal option is selected.</p> <p>It may be necessary to manually add the internal option in the printer driver to make it available for print jobs. For more information, see “Adding available options in the print driver” on page 41.</p> <p>b Resend the print job.</p> <p>Does the internal option operate correctly?</p>	The problem is solved.	Contact customer support.

Internal print server does not operate correctly

Action	Yes	No
<p>Step 1</p> <p>Reinstall the internal print server.</p> <p>a Remove, and then install the internal print server. For more information, see “Installing an Internal Solutions Port” on page 27.</p> <p>b Print a menu settings page, and then check if the internal print server is listed in the Installed Features list.</p> <p>Is the internal print server listed in the Installed Features list?</p>	Go to step 2.	<p>Check if the internal print server is supported by the printer.</p> <p>Note: An internal print server from another printer may not work with this printer.</p>
<p>Step 2</p> <p>Check the cable and the internal print server connection.</p> <p>Use the correct cable, and then check if it is securely connected to the internal print server.</p> <p>Does the internal print server operate correctly?</p>	The problem is solved.	Contact customer support.

Internal Solutions Port does not operate correctly

Action	Yes	No
<p>Step 1 Make sure the Internal Solutions Port (ISP) is installed.</p> <p>a Install the ISP. For more information, see “Installing an Internal Solutions Port” on page 27.</p> <p>b Print a menu settings page, and then check if the ISP is listed in the Installed Features list.</p> <p>Is the ISP listed in the Installed Features list?</p>	Go to step 2.	<p>Check if you have a supported ISP.</p> <p>Note: An ISP from another printer may not work on this printer.</p>
<p>Step 2 Check the cable and the ISP connection.</p> <p>a Use the correct cable, and then make sure it is securely connected to the ISP.</p> <p>b Check if the ISP solution interface cable is securely connected into the receptacle of the controller board.</p> <p>Note: The ISP solution interface cable and the receptacle on the controller board are color-coded.</p> <p>Does the Internal Solutions Port operate correctly?</p>	The problem is solved.	Contact customer support .

Tray problems

Action	Yes	No
<p>Step 1</p> <p>a Pull out the tray, and then do one or more of the following:</p> <ul style="list-style-type: none"> • Check for paper jams or misfeeds. • Check if the paper size indicators on the paper guides are aligned with the paper size indicators on the tray. • If you are printing on custom-size paper, then make sure that the paper guides rest against the edges of the paper. • Make sure the paper is below the maximum paper fill indicator. • Make sure paper lies flat in the tray. <p>b Check if the tray closes properly.</p> <p>Is the tray working?</p>	The problem is solved.	Go to step 2.
<p>Step 2</p> <p>a Turn off the printer, then wait about 10 seconds, and then turn the printer back on.</p> <p>b Resend the print job.</p> <p>Is the tray working?</p>	The problem is solved.	Go to step 3.

Action	Yes	No
<p>Step 3</p> <p>Check if the tray is installed and recognized by the printer.</p> <p>Print a menu settings page, and then check if the tray is listed in the Installed Features list.</p> <p>Is the tray listed in the menu settings page?</p>	Go to step 4.	Reinstall the tray. For more information, see the setup documentation that came with the tray.
<p>Step 4</p> <p>Check if the tray is available in the printer driver.</p> <p>Note: If necessary, manually add the tray in the printer driver to make it available for print jobs. For more information, see “Adding available options in the print driver” on page 41.</p> <p>Is the tray available in the printer driver?</p>	The problem is solved.	Contact customer support .

USB/parallel interface card does not operate correctly

Action	Yes	No
<p>Step 1</p> <p>Make sure the USB or parallel interface card is installed.</p> <p>a Install the USB or parallel interface card. For more information, see “Installing an Internal Solutions Port” on page 27.</p> <p>b Print a menu settings page, and then check if the USB or parallel interface card is listed in the Installed Features list.</p> <p>Is the USB or parallel interface card listed in the Installed Features list?</p>	Go to step 2.	<p>Check if you have a supported USB or parallel interface card.</p> <p>Note: A USB or parallel interface card from another printer may not work on this printer.</p>
<p>Step 2</p> <p>Check the cable and the USB or parallel interface card connection.</p> <p>Use the correct cable, and then make sure it is securely connected to the USB or parallel interface card.</p> <p>Does the USB or parallel interface card operate correctly?</p>	The problem is solved.	Contact customer support .

Paper feed problems

Jammed pages are not reprinted

Action	Yes	No
<p>Turn on Jam Recovery.</p> <p>a From the home screen, navigate to:</p> <p> > Settings > General Settings > Print Recovery</p> <p>b From the Jam Recovery menu, select On or Auto.</p> <p>c Save your changes.</p> <p>Do pages reprint after a jam?</p>	<p>The problem is solved.</p>	<p>Contact customer support.</p>

Paper frequently jams

Action	Yes	No
<p>Step 1</p> <p>a Pull out the tray, and then do one or more of the following:</p> <ul style="list-style-type: none"> • Make sure paper lies flat in the tray. • Check if the paper size indicators on the paper guides are aligned with the paper size indicators on the tray. • Check if the paper guides are aligned against the edges of the paper. • Make sure the paper is below the maximum paper fill indicator. • Check if you are printing on a recommended paper size and type. <p>b Insert the tray properly.</p> <p>If jam recovery is enabled, then the print jobs will reprint automatically.</p> <p>Do paper jams still occur frequently?</p>	<p>Go to step 2.</p>	<p>The problem is solved.</p>
<p>Step 2</p> <p>a Load paper from a fresh package.</p> <p>Note: Paper absorbs moisture due to high humidity. Store paper in its original wrapper until you use it.</p> <p>b Resend the print job.</p> <p>Do paper jams still occur frequently?</p>	<p>Go to step 3.</p>	<p>The problem is solved.</p>

Action	Yes	No
<p>Step 3</p> <p>a Review the tips on avoiding jams. For more information, see “Avoiding jams” on page 164.</p> <p>b Follow the recommendations, and then resend the print job.</p> <p>Do paper jams still occur frequently?</p>	<p>Contact customer support.</p>	<p>The problem is solved.</p>

Paper jam message remains after jam is cleared

Action	Yes	No
<p>Check the entire paper path for jammed paper.</p> <p>a Remove any jammed paper.</p> <p>b From the printer control panel, touch Continue to clear the message.</p> <p>Does the paper jam message remain?</p>	<p>Contact customer support.</p>	<p>The problem is solved.</p>

Solving print problems

Printing problems

Confidential and other held jobs do not print

Note: Confidential, Verify, Reserve, and Repeat print jobs may be deleted if the printer requires extra memory to process additional held jobs.

Action	Yes	No
<p>Step 1</p> <p>Open the held jobs folder on the printer display, and then verify that your print job is listed.</p> <p>Is your print job listed in the held jobs folder?</p>	Go to step 2.	Select one of the Print and Hold options, and then resend the print job. For more information, see “Printing held jobs” on page 68.
<p>Step 2</p> <p>The print job may contain a formatting error or invalid data.</p> <ul style="list-style-type: none"> • Delete the print job, and then send it again. • For PDF files, generate a new PDF, and then print it again. <p>If you are printing from the Internet, then the printer may be reading multiple job titles as duplicates and deleting all jobs except the first one.</p> <p>For Windows users</p> <ol style="list-style-type: none"> Open the Print Properties folder. From the Print and Hold dialog, select the “Keep duplicate documents” check box. Enter a PIN number. <p>For Macintosh users</p> <p>Save each print job, name each job differently, and then send the individual jobs to the printer.</p> <p>Does the job print?</p>	The problem is solved.	Go to step 3.
<p>Step 3</p> <p>Free up additional printer memory by deleting some of the held jobs.</p> <p>Does the job print?</p>	The problem is solved.	Add additional printer memory.

Envelope seals when printing

Action	Yes	No
<p>a Use envelopes that have been stored in a dry environment. Note: Printing on envelopes with high moisture content can seal the flaps.</p> <p>b Resend the print job.</p> <p>Does the envelope seal when printing?</p>	Contact customer support .	The problem is solved.

Error message about reading the flash drive appears

Action	Yes	No
<p>Step 1 Check if the flash drive is inserted into the front USB port. Note: The flash drive will not work if it is inserted into the rear USB port.</p> <p>Is the flash drive inserted into the front USB port?</p>	Go to step 2.	Insert the flash drive into the front USB port.
<p>Step 2 Check if the indicator light on the printer control panel is blinking green. Note: A green blinking light indicates that the printer is busy.</p> <p>Is the indicator light blinking green?</p>	Wait until the printer is ready, then view the held jobs list, and then print the documents.	Go to step 3.
<p>Step 3 a Check for an error message on the display. b Clear the message.</p> <p>Does the error message still appear?</p>	Go to step 4.	The problem is solved.
<p>Step 4 Check if the flash drive is supported. For more information on tested and approved USB flash drives, see “Supported flash drives and file types” on page 67.</p> <p>Does the error message still appear?</p>	Go to step 5.	The problem is solved.
<p>Step 5 Check if the USB port is disabled by the system support person.</p> <p>Does the error message still appear?</p>	Contact customer support .	The problem is solved.

Incorrect characters print

Action	Yes	No
<p>Step 1 Make sure that the printer is not in Hex Trace mode.</p> <p>Note: If Ready Hex appears on the display, then turn off the printer, and then turn it back on to deactivate Hex Trace mode.</p> <p>Is the printer in Hex Trace mode?</p>	Deactivate Hex Trace mode.	Go to step 2.
<p>Step 2</p> <p>a From the control panel, select Standard Network or Network [x], and then set PCL SmartSwitch or PS SmartSwitch to On.</p> <p>b Resend the print job.</p> <p>Do incorrect characters print?</p>	Contact customer support .	The problem is solved.

Job prints from the wrong tray or on the wrong paper

Action	Yes	No
<p>Step 1</p> <p>a Check if you are printing on paper that is supported by the tray.</p> <p>b Resend the print job.</p> <p>Did the job print from the correct tray or on the correct paper?</p>	The problem is solved.	Go to step 2.
<p>Step 2</p> <p>a From the Paper menu on the printer control panel, set the paper size and type to match the paper loaded in the tray.</p> <p>b Resend the print job.</p> <p>Did the job print from the correct tray or on the correct paper?</p>	The problem is solved.	Go to step 3.
<p>Step 3</p> <p>a Depending on your operating system, open Printing Preferences or the Print dialog, and then specify the paper type.</p> <p>b Resend the print job.</p> <p>Did the job print from the correct tray or on the correct paper?</p>	The problem is solved.	Go to step 4.
<p>Step 4</p> <p>a Check if the trays are not linked.</p> <p>b Resend the print job.</p> <p>Did the job print from the correct tray or on the correct paper?</p>	The problem is solved.	Contact customer support .

Large jobs do not collate

Action	Yes	No
<p>Step 1</p> <p>a From the Finishing menu on the printer control panel, set Collate to (1,2,3) (1,2,3).</p> <p>b Resend the print job.</p> <p>Did the job print and collate correctly?</p>	The problem is solved.	Go to step 2.
<p>Step 2</p> <p>a From the printer software, set Collate to (1,2,3) (1,2,3).</p> <p>Note: Setting Collate to (1,1,1) (2,2,2) in the software overrides the setting in the Finishing menu.</p> <p>b Resend the print job.</p> <p>Did the job print and collate correctly?</p>	The problem is solved.	Go to step 3.
<p>Step 3</p> <p>Reduce the complexity of the print job by eliminating the number and size of fonts, the number and complexity of images, and the number of pages in the job.</p> <p>Did the job print and collate correctly?</p>	The problem is solved.	Contact customer support .

Multiple-language PDF files do not print

Action	Yes	No
<p>Step 1</p> <p>a Check if the print options for the PDF output are set to embed all fonts.</p> <p>For more information, see the documentation that came with Adobe Acrobat.</p> <p>b Generate a new PDF file, and then resend the print job.</p> <p>Do the files print?</p>	The problem is solved.	Go to step 2.
<p>Step 2</p> <p>a Open the document you want to print in Adobe Acrobat.</p> <p>b Click File > Print > Advanced > Print As Image > OK > OK.</p> <p>Do the files print?</p>	The problem is solved.	Contact customer support .

Print job takes longer than expected

Action	Yes	No
<p>Step 1</p> <p>a Disable Eco-Mode. From the control panel, navigate to: Settings > General Settings > Eco-Mode > Off</p> <p>Note: Disabling Eco-Mode may increase the consumption of energy or paper, or both.</p> <p>b Resend the print job.</p> <p>Did the job print?</p>	The problem is solved.	Go to step 2.
<p>Step 2</p> <p>Reduce the number and size of fonts, the number and complexity of images, and the number of pages in the print job, and then resend the job.</p> <p>Did the job print?</p>	The problem is solved.	Go to step 3.
<p>Step 3</p> <p>a Remove held jobs stored in the printer memory.</p> <p>b Resend the print job.</p> <p>Did the job print?</p>	The problem is solved.	Go to step 4.
<p>Step 4</p> <p>a Disable the Page Protect feature. From the control panel, navigate to: Settings > General Settings > Print Recovery > Page Protect > Off</p> <p>b Resend the print job.</p> <p>Did the job print?</p>	The problem is solved.	Go to step 5.
<p>Step 5</p> <p>a Check if the cable connections to the printer and print server are secure. For more information, see the setup documentation that came with the printer.</p> <p>b Resend the print job.</p> <p>Did the job print?</p>	The problem is solved.	Go to step 6.
<p>Step 6</p> <p>Install additional printer memory, and then resend the print job.</p> <p>Did the job print?</p>	The problem is solved.	Contact customer support .

Print jobs do not print

Action	Yes	No
<p>Step 1</p> <p>a From the document you are trying to print, open the Print dialog and check if you have selected the correct printer.</p> <p>Note: If the printer is not the default printer, then you must select the printer for each document that you want to print.</p> <p>b Resend the print job.</p> <p>Do the jobs print?</p>	The problem is solved.	Go to step 2.
<p>Step 2</p> <p>a Check if the printer is plugged in and turned on, and if Ready appears on the printer display.</p> <p>b Resend the print job.</p> <p>Do the jobs print?</p>	The problem is solved.	Go to step 3.
<p>Step 3</p> <p>If an error message appears on the printer display, then clear the message.</p> <p>Note: The printer continues to print after clearing the message.</p> <p>Do the jobs print?</p>	The problem is solved.	Go to step 4.
<p>Step 4</p> <p>a Check if the ports (USB, serial, or Ethernet) are working and if the cables are securely connected to the computer and the printer.</p> <p>Note: For more information, see the setup documentation that came with the printer.</p> <p>b Resend the print job.</p> <p>Do the jobs print?</p>	The problem is solved.	Go to step 5.
<p>Step 5</p> <p>a Turn off the printer, then wait for about 10 seconds, and then turn the printer back on.</p> <p>b Resend the print job.</p> <p>Do the jobs print?</p>	The problem is solved.	Go to step 6.
<p>Step 6</p> <p>a Remove, and then reinstall the printer software. For more information, see “Installing the printer” on page 41.</p> <p>Note: The printer software is available at http://support.lexmark.com.</p> <p>b Resend the print job.</p> <p>Do the jobs print?</p>	The problem is solved.	Contact customer support .

Tray linking does not work

Notes:

- The trays can detect paper length.
- The multipurpose feeder does not automatically detect the paper size. You must set the size from the Paper Size/Type menu.

Action	Yes	No
<p>Step 1</p> <p>a Open the trays, and then check if they contain paper of the same size and type.</p> <ul style="list-style-type: none"> • Check if the paper guides are in the correct positions for the size of the paper loaded in each tray. • Check if the paper size indicators on the paper guides are aligned with the paper size indicators on the tray. <p>b Resend the print job.</p> <p>Do the trays link correctly?</p>	<p>The problem is solved.</p>	<p>Go to step 2.</p>
<p>Step 2</p> <p>a From the printer control panel, set the paper size and type in the Paper menu to match the paper loaded in the trays to be linked.</p> <p>Note: The paper size and type must match for trays to be linked.</p> <p>b Resend the print job.</p> <p>Do the trays link correctly?</p>	<p>The problem is solved.</p>	<p>Contact customer support.</p>

Unexpected page breaks occur

Action	Yes	No
<p>Increase the printing timeout.</p> <p>a From the home screen, navigate to:</p> <p> > Settings > General Settings > Timeouts</p> <p>b Increase the Print Timeout setting, and then touch Submit.</p> <p>c Resend the print job.</p> <p>Did the file print correctly?</p>	<p>The problem is solved.</p>	<p>Check the original file for manual page breaks.</p>

Print quality problems

Characters have jagged or uneven edges

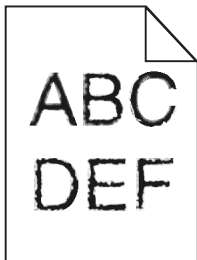

Action	Yes	No
<p>Step 1</p> <p>a Print a font sample list to check if the fonts you are using are supported by the printer.</p> <p>1 From the printer control panel, navigate to:</p> <p> > Reports > Print Fonts</p> <p>2 Touch PCL Fonts or PostScript Fonts.</p> <p>b Use a font that is supported by the printer or install the font that you want to use. For more information, contact your system support person.</p> <p>c Resend the print job.</p> <p>Do prints still contain characters that have jagged or uneven edges?</p>	Go to step 2.	The problem is solved.
<p>Step 2</p> <p>a Use a font that is supported by the printer or install the font that you want to use on your computer. For more information, contact your system support person.</p> <p>b Resend the print job.</p> <p>Do prints still contain characters that have jagged or uneven edges?</p>	Contact customer support .	The problem is solved.

Clipped pages or images

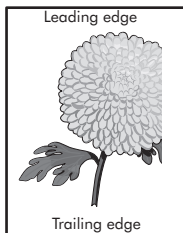
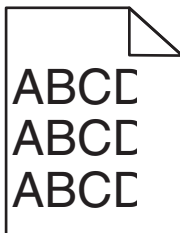

Action	Yes	No
<p>Step 1</p> <p>a Move the paper guides in the tray to the correct positions for the paper loaded.</p> <p>b Resend the print job.</p> <p>Is the page or image clipped?</p>	<p>Go to step 2.</p>	<p>The problem is solved.</p>
<p>Step 2</p> <p>From the control panel, set the paper size and type in the Paper menu to match the paper loaded in the tray.</p> <p>Do the paper size and type match the paper loaded in the tray?</p>	<p>Go to step 3.</p>	<p>Do one or more of the following:</p> <ul style="list-style-type: none"> • Specify the paper size from the tray settings to match the paper loaded in the tray. • Change the paper loaded in the tray to match the paper size specified in the tray settings.
<p>Step 3</p> <p>a Depending on your operating system, specify the paper size from Printing Preferences or from the Print dialog.</p> <p>b Resend the print job.</p> <p>Is the page or image clipped?</p>	<p>Go to step 4.</p>	<p>The problem is solved.</p>
<p>Step 4</p> <p>a Clean the charger and the printhead lens.</p> <p>b Resend the print job.</p> <p>Is the page or image clipped?</p>	<p>Go to step 5.</p>	<p>The problem is solved.</p>
<p>Step 5</p> <p>a Remove, and then reinstall the photoconductor unit.</p> <p>Warning—Potential Damage: Do not expose the photoconductor unit to direct light for more than 10 minutes. Extended exposure to light may cause print quality problems.</p> <p>b Resend the print job.</p> <p>Is the page or image clipped?</p>	<p>Contact customer support.</p>	<p>The problem is solved.</p>

Gray background on prints

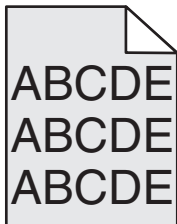

Action	Yes	No
<p>Step 1</p> <p>a From the Quality menu on the control panel, decrease the toner darkness.</p> <p>b Resend the print job.</p> <p>Did the gray background disappear from the prints?</p>	The problem is solved.	Go to step 2.
<p>Step 2</p> <p>a Remove, and then reinstall the photoconductor unit and the toner cartridge.</p> <p>Warning—Potential Damage: Do not expose the photoconductor unit to direct light for more than 10 minutes. Extended exposure to light can cause print quality problems.</p> <p>b Resend the print job.</p> <p>Did the gray background disappear from the prints?</p>	The problem is solved.	Go to step 3.
<p>Step 3</p> <p>a Clean the charger and the printhead lens.</p> <p>b Resend the print job.</p> <p>Did the gray background disappear from the prints?</p>	The problem is solved.	Go to step 4.
<p>Step 4</p> <p>Replace the photoconductor unit, and then resend the print job.</p> <p>Did the gray background disappear from the prints?</p>	The problem is solved.	Contact customer support .

Horizontal voids appear on prints

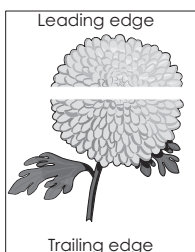

Action	Yes	No
<p>Step 1</p> <p>a Make sure that your software program is using a correct fill pattern.</p> <p>b Resend the print job.</p> <p>Do horizontal voids appear on prints?</p>	Go to step 2.	The problem is solved.
<p>Step 2</p> <p>a Load the specified tray or feeder with a recommended type of paper.</p> <p>b Resend the print job.</p> <p>Do horizontal voids appear on prints?</p>	Go to step 3.	The problem is solved.
<p>Step 3</p> <p>a Remove, and then reinstall the photoconductor unit.</p> <p>Warning—Potential Damage: Do not expose the photoconductor unit to direct light for more than 10 minutes. Extended exposure to light can cause print quality problems.</p> <p>b Resend the print job.</p> <p>Do horizontal voids appear on prints?</p>	Go to step 4.	The problem is solved.
<p>Step 4</p> <p>a Clean the charger and the printhead lens.</p> <p>b Resend the print job.</p> <p>Do horizontal voids appear on prints?</p>	Go to step 5.	The problem is solved.
<p>Step 5</p> <p>Replace the photoconductor unit, and then resend the print job.</p> <p>Do horizontal voids appear on prints?</p>	Contact customer support .	The problem is solved.

Incorrect margins on prints

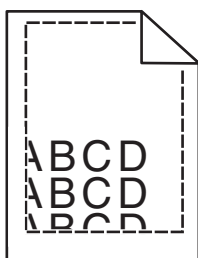

Action	Yes	No
<p>Step 1</p> <p>a Move the width and length guides in the tray to the correct positions for the paper size loaded.</p> <p>b Resend the print job.</p> <p>Are the margins correct?</p>	The problem is solved.	Go to step 2.
<p>Step 2</p> <p>From the printer control panel, set the paper size in the Paper menu to match the paper loaded in the tray.</p> <p>Does the paper size match the paper loaded in the tray?</p>	Go to step 3.	<p>Do one or more of the following:</p> <ul style="list-style-type: none"> Specify the paper size from the tray settings to match the paper loaded in the tray. Change the paper loaded in the tray to match the paper size specified in the tray settings.
<p>Step 3</p> <p>a Depending on your operating system, specify the paper size from Printing Preferences or from the Print dialog.</p> <p>b Resend the print job.</p> <p>Are the margins correct?</p>	The problem is solved.	Contact customer support .

Paper curl

Action	Yes	No
<p>Step 1</p> <p>Move the width and length guides in the tray to the correct positions for the size of the paper loaded.</p> <p>Are the width and length guides positioned correctly?</p>	Go to step 2.	Adjust the width and length guides.
<p>Step 2</p> <p>From the printer control panel, set the paper type and weight in the Paper menu to match the paper loaded in the tray.</p> <p>Do the paper type and weight match the type and weight of the paper in the tray?</p>	Go to step 3.	Specify the paper type and weight from the tray settings to match the paper loaded in the tray.

Action	Yes	No
<p>Step 3</p> <p>a Depending on your operating system, specify the paper type and weight from Printing Preferences or from the Print dialog.</p> <p>b Resend the print job.</p> <p>Is the paper still curled?</p>	Go to step 4.	The problem is solved.
<p>Step 4</p> <p>a Remove the paper from the tray, and then turn it over.</p> <p>b Resend the print job.</p> <p>Is the paper still curled?</p>	Go to step 5.	The problem is solved.
<p>Step 5</p> <p>a Load paper from a fresh package.</p> <p>Note: Paper absorbs moisture due to high humidity. Store paper in its original wrapper until you use it.</p> <p>b Resend the print job.</p> <p>Is the paper still curled?</p>	Contact customer support .	The problem is solved.

Print irregularities

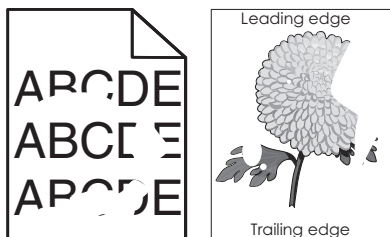

Action	Yes	No
<p>Step 1</p> <p>a Move the paper guides in the tray to the correct positions for the paper size loaded in the tray.</p> <p>b Resend the print job.</p> <p>Do print irregularities still appear?</p>	Go to step 2.	The problem is solved.
<p>Step 2</p> <p>From the control panel, set the paper size and type in the Paper menu to match the paper loaded in the tray.</p> <p>Do the printer settings match the size and type of the paper loaded in the tray?</p>	Go to step 3.	Specify the paper size and type in the tray settings to match the paper loaded in the tray.

Action	Yes	No
<p>Step 3</p> <p>a Depending on your operating system, specify the paper type and weight in Printing Preferences or in the Print dialog.</p> <p>b Resend the print job.</p> <p>Do print irregularities still appear?</p>	Go to step 4.	The problem is solved.
<p>Step 4</p> <p>Check if the paper loaded in the tray has texture or rough finishes.</p> <p>Are you printing on textured or rough paper?</p>	From the control panel, set the paper texture in the Paper menu to match the paper loaded in the tray.	Go to step 5.
<p>Step 5</p> <p>a Load paper from a fresh package.</p> <p>Note: Paper absorbs moisture due to high humidity. Store paper in its original wrapper until you use it.</p> <p>b Resend the print job.</p> <p>Do print irregularities still appear?</p>	Go to step 6.	The problem is solved.
<p>Step 6</p> <p>a Clean the charger and the printhead lens.</p> <p>b Resend the print job.</p> <p>Do print irregularities still appear?</p>	Go to step 7.	The problem is solved.
<p>Step 7</p> <p>Replace the photoconductor unit, and then resend the print job.</p> <p>Warning—Potential Damage: Do not expose the photoconductor unit to direct light for more than 10 minutes. Extended exposure to light can cause print quality problems.</p> <p>Do print irregularities still appear?</p>	Contact customer support or your service representative.	The problem is solved.

Print is too dark

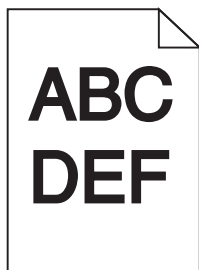

Action	Yes	No
<p>Step 1</p> <p>a From the Quality menu on the control panel, reduce the toner darkness.</p> <p>Note: 8 is the factory default setting.</p> <p>b Resend the print job.</p> <p>Is the print still too dark?</p>	<p>Go to step 2.</p>	<p>The problem is solved.</p>
<p>Step 2</p> <p>a From the control panel, set the paper type, texture, and weight in the Paper menu to match the paper loaded in the tray.</p> <p>b Resend the print job.</p> <p>Is the tray set to the type, texture, and weight of the paper loaded?</p>	<p>Go to step 3.</p>	<p>Do one or more of the following:</p> <ul style="list-style-type: none"> • Specify the paper type, texture, and weight from the tray settings to match the paper loaded in the tray. • Change the paper loaded in the tray to match the paper type, texture, and weight specified in the tray settings.
<p>Step 3</p> <p>a Depending on your operating system, specify the paper type, texture, and weight from Printing Preferences or from the Print dialog.</p> <p>b Resend the print job.</p> <p>Is the print still too dark?</p>	<p>Go to step 4.</p>	<p>The problem is solved.</p>
<p>Step 4</p> <p>Check if the paper loaded in the tray has texture or rough finishes.</p> <p>Are you printing on textured or rough paper?</p>	<p>From the control panel, change the texture settings in the Paper Texture menu to match the paper you are printing on.</p>	<p>Go to step 5.</p>
<p>Step 5</p> <p>a Load paper from a fresh package.</p> <p>Note: Paper absorbs moisture due to high humidity. Store paper in its original wrapper until you use it.</p> <p>b Resend the print job.</p> <p>Is the print still too dark?</p>	<p>Go to step 6.</p>	<p>The problem is solved.</p>

Action	Yes	No
<p>Step 6</p> <p>a Clean the charger and the printhead lens.</p> <p>b Resend the print job.</p> <p>Is the print still too dark?</p>	Go to step 7.	The problem is solved.
<p>Step 7</p> <p>Replace the photoconductor unit, and then resend the print job.</p> <p>Warning—Potential Damage: Do not expose the photoconductor unit to direct light for more than 10 minutes. Extended exposure to light can cause print quality problems.</p> <p>Is the print still too dark?</p>	Contact customer support .	The problem is solved.

Print is too light



Action	Yes	No
<p>Step 1</p> <p>a From the Quality menu on the control panel, increase the toner darkness.</p> <p>Note: 8 is the factory default setting.</p> <p>b Resend the print job.</p> <p>Is the print still too light?</p>	Go to step 2.	The problem is solved.
<p>Step 2</p> <p>From the control panel, set the paper type, texture, and weight in the Paper menu to match the paper loaded in the tray.</p> <p>Is the tray set to the type, texture, and weight of the paper loaded?</p>	Go to step 3.	Change the paper type, texture, and weight to match the paper loaded in the tray.
<p>Step 3</p> <p>a Depending on your operating system, specify the paper type, texture, and weight from Printing Preferences or from the Print dialog.</p> <p>b Resend the print job.</p> <p>Is the print still too light?</p>	Go to step 4.	The problem is solved.

Action	Yes	No
<p>Step 4 Make sure that the paper has no texture or rough finishes.</p> <p>Are you printing on textured or rough paper?</p>	<p>From the control panel, change the texture settings in the Paper Texture menu to match the paper you are printing on.</p>	<p>Go to step 5.</p>
<p>Step 5 a Load paper from a fresh package. Note: Paper absorbs moisture due to high humidity. Store paper in its original wrapper until you use it. b Resend the print job.</p> <p>Is the print still too light?</p>	<p>Go to step 6.</p>	<p>The problem is solved.</p>
<p>Step 6 a Clean the charger and the printhead lens. b Resend the print job.</p> <p>Is the print still too light?</p>	<p>Go to step 7.</p>	<p>The problem is solved.</p>
<p>Step 7 Replace the photoconductor unit, and then resend the print job. Warning—Potential Damage: Do not expose the photoconductor unit to direct light for more than 10 minutes. Extended exposure to light can cause print quality problems.</p> <p>Is the print still too light?</p>	<p>Contact customer support.</p>	<p>The problem is solved.</p>

Printer is printing blank pages

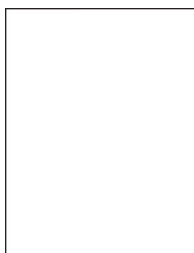

Action	Yes	No
<p>Step 1</p> <p>a Check if there is a packing material left on the photoconductor unit.</p> <p>1 Remove the photoconductor unit.</p> <p>2 Check if the packing material is properly removed from the photoconductor unit.</p> <p>Warning—Potential Damage: Do not expose the photoconductor unit to direct light for more than 10 minutes. Extended exposure to light may cause print quality problems.</p> <p>3 Reinstall the photoconductor unit.</p> <p>b Resend the print job.</p> <p>Is the printer still printing blank pages?</p>	Go to step 2.	The problem is solved.
<p>Step 2</p> <p>a Clean the charger and the printhead lens.</p> <p>b Resend the print job.</p> <p>Is the printer still printing blank pages?</p>	Go to step 3.	The problem is solved.
<p>Step 3</p> <p>Replace the photoconductor unit, and then resend the print job.</p> <p>Is the printer still printing blank pages?</p>	Contact customer support .	The problem is solved.

Printer is printing solid black pages

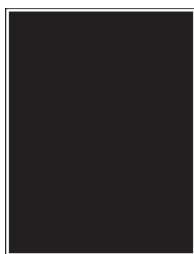

Action	Yes	No
<p>Step 1</p> <p>a Reinstall the photoconductor unit.</p> <p>Warning—Potential Damage: Do not expose the photoconductor unit to direct light for more than 10 minutes. Extended exposure to light may cause print quality problems.</p> <p>b Resend the print job.</p> <p>Is the printer printing solid black pages?</p>	Go to step 2.	The problem is solved.

Action	Yes	No
<p>Step 2</p> <p>a Clean the charger and the printhead lens.</p> <p>b Resend the print job.</p> <p>Is the printer printing solid black pages?</p>	Go to step 3.	The problem is solved.
<p>Step 3</p> <p>Replace the photoconductor unit, and then resend the print job.</p> <p>Is the printer printing solid black pages?</p>	Contact customer support .	The problem is solved.

Repeating defects appear on prints

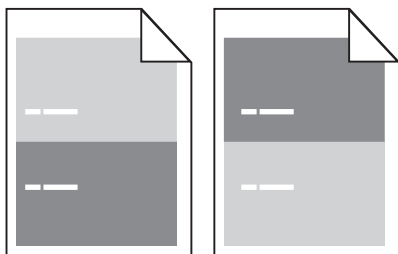

Action	Yes	No
<p>Step 1</p> <p>a Clean the charger and the printhead lens.</p> <p>b Resend the print job.</p> <p>Do repeating defects still appear on prints?</p>	Go to step 2.	The problem is solved.
<p>Step 2</p> <p>a Replace the photoconductor unit if the distance between the defects is equal to 95.8 mm (3.77 in.).</p> <p>b Resend the print job.</p> <p>Do repeating defects still appear on prints?</p>	Go to step 3.	The problem is solved.
<p>Step 3</p> <p>a Replace the 300K maintenance kit if the distance between the defects is equal to either of the following:</p> <ul style="list-style-type: none"> • 62.65 mm (2.47 in.) • 75.85 mm (2.99 in.) <p>b Resend the print job.</p> <p>Do repeating defects still appear on prints?</p>	Contact customer support .	The problem is solved.

Shadow images appear on prints

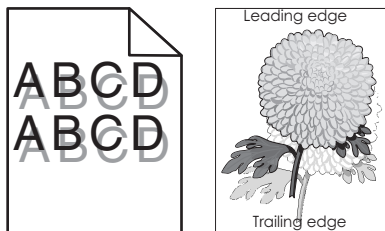

Action	Yes	No
<p>Step 1 Load paper with the correct paper type and weight in the tray.</p> <p>Is paper with the correct paper type and weight loaded in the tray?</p>	Go to step 2.	Load paper with the correct paper type and weight in the tray.
<p>Step 2 From the control panel, set the paper type and weight in the Paper menu to match the paper loaded in the tray.</p> <p>Is the tray set to the type and weight of the paper loaded?</p>	Go to step 3.	Change the paper loaded in the tray to match the paper type and weight specified in the tray settings.
<p>Step 3</p> <ul style="list-style-type: none"> a Depending on your operating system, specify the paper type and weight from Printing Preferences or from the Print dialog. b Resend the print job. <p>Do shadow images still appear on prints?</p>	Go to step 4.	The problem is solved.
<p>Step 4</p> <ul style="list-style-type: none"> a Clean the charger and the printhead lens. b Resend the print job. <p>Do shadow images still appear on prints?</p>	Go to step 5.	The problem is solved.
<p>Step 5 Replace the photoconductor unit, and then resend the print job.</p> <p>Warning—Potential Damage: Do not expose the photoconductor unit to direct light for more than 10 minutes. Extended exposure to light can cause print quality problems.</p> <p>Do shadow images still appear on prints?</p>	Contact customer support .	The problem is solved.

Skewed print

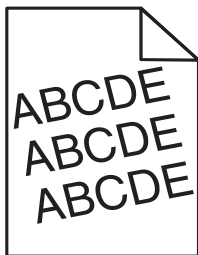

Action	Yes	No
<p>Step 1</p> <p>a Move the width and length guides in the tray to the correct positions for the size of the paper loaded.</p> <p>b Resend the print job.</p> <p>Is the print still skewed?</p>	Go to step 2.	The problem is solved.
<p>Step 2</p> <p>a Check if you are printing on a paper that is supported by the tray.</p> <p>b Resend the print job.</p> <p>Is the print still skewed?</p>	Contact customer support .	The problem is solved.

Streaked horizontal lines appear on prints

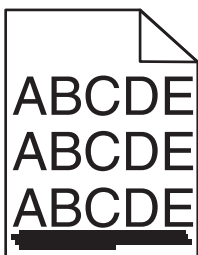

Action	Yes	No
<p>Step 1</p> <p>a Depending on your operating system, specify the tray or feeder from Printing Preferences or the Print dialog.</p> <p>b Resend the print job.</p> <p>Do streaked horizontal lines appear on prints?</p>	Go to step 2.	The problem is solved.
<p>Step 2</p> <p>From the control panel, set the paper type and weight in the Paper menu to match the paper loaded in the tray.</p> <p>Do the paper type and weight match the type and weight of the paper in the tray?</p>	Go to step 3.	Change the paper type and weight to match the paper loaded in the tray.

Action	Yes	No
<p>Step 3</p> <p>a Load paper from a fresh package.</p> <p>Note: Paper absorbs moisture due to high humidity. Store paper in its original wrapper until you use it.</p> <p>b Resend the print job.</p> <p>Do streaked horizontal lines appear on prints?</p>	Go to step 4.	The problem is solved.
<p>Step 4</p> <p>a Remove, and then reinstall the photoconductor unit.</p> <p>Warning—Potential Damage: Do not expose the photoconductor unit to direct light for more than 10 minutes. Extended exposure to light may cause print quality problems.</p> <p>b Resend the print job.</p> <p>Do streaked horizontal lines appear on prints?</p>	Go to step 5.	The problem is solved.
<p>Step 5</p> <p>a Clean the charger and the printhead lens.</p> <p>b Resend the print job.</p> <p>Do streaked horizontal lines appear on prints?</p>	Go to step 6.	The problem is solved.
<p>Step 6</p> <p>Replace the photoconductor unit, and then resend the print job.</p> <p>Do streaked horizontal lines appear on prints?</p>	Contact customer support .	The problem is solved.

Streaked vertical lines appear on prints

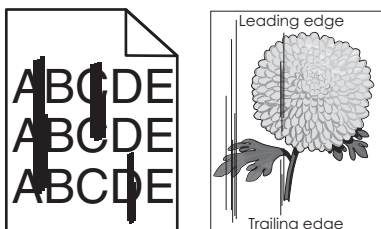

Action	Yes	No
<p>Step 1</p> <p>a Depending on your operating system, specify the paper type, texture, and weight from Printing Preferences or from the Print dialog.</p> <p>b Resend the print job.</p> <p>Do streaked vertical lines appear on prints?</p>	Go to step 2.	The problem is solved.

Action	Yes	No
<p>Step 2</p> <p>From the control panel, set the paper texture, type, and weight in the Paper menu to match the paper loaded in the tray.</p> <p>Do the paper texture, type, and weight match the paper in the tray?</p>	<p>Go to step 3.</p>	<p>Do one or more of the following:</p> <ul style="list-style-type: none"> • Specify the paper texture, type, and weight from the tray settings to match the paper loaded in the tray. • Change the paper loaded in the tray to match the paper texture, type, and weight specified in the tray settings.
<p>Step 3</p> <p>a Load paper from a fresh package.</p> <p>Note: Paper absorbs moisture due to high humidity. Store paper in its original wrapper until you use it.</p> <p>b Resend the print job.</p> <p>Do streaked vertical lines appear on prints?</p>	<p>Go to step 4.</p>	<p>The problem is solved.</p>
<p>Step 4</p> <p>a Remove, and then reinstall the photoconductor unit.</p> <p>1 Remove the photoconductor unit.</p> <p>Warning—Potential Damage: Do not expose the photoconductor unit to direct light for more than 10 minutes. Extended exposure to light may cause print quality problems.</p> <p>2 Install the photoconductor unit.</p> <p>b Resend the print job.</p> <p>Do streaked vertical lines appear on prints?</p>	<p>Go to step 5.</p>	<p>The problem is solved.</p>
<p>Step 5</p> <p>a Clean the charger and the printhead lens.</p> <p>b Resend the print job.</p> <p>Do streaked vertical lines appear on prints?</p>	<p>Go to step 6.</p>	<p>The problem is solved.</p>
<p>Step 6</p> <p>Replace the photoconductor unit, and then resend the print job.</p> <p>Do streaked vertical lines appear on prints?</p>	<p>Contact customer support.</p>	<p>The problem is solved.</p>

Toner fog or background shading appears on prints

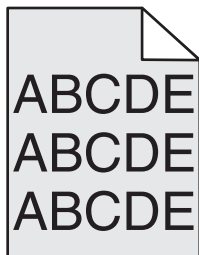

Action	Yes	No
<p>Step 1</p> <p>a Clean the charger and the printhead lens.</p> <p>b Resend the print job.</p> <p>Did the toner fog or background shading disappear from the prints?</p>	Go to step 2.	The problem is solved.
<p>Step 2</p> <p>a Reinstall the photoconductor unit.</p> <p>Warning—Potential Damage: Do not expose the photoconductor unit to direct light for more than 10 minutes. Extended exposure to light may cause print quality problems.</p> <p>b Resend the print job.</p> <p>Did the toner fog or background shading disappear from the prints?</p>	The problem is solved.	Go to step 3.
<p>Step 3</p> <p>Replace the photoconductor unit, and then resend the print job.</p> <p>Did the toner fog or background shading disappear from the prints?</p>	The problem is solved.	Contact customer support .

Toner rubs off

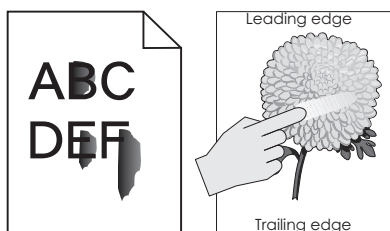

Action	Yes	No
<p>Step 1 From the Paper menu on the printer control panel, check the paper type, texture, and weight.</p> <p>Do the paper type, texture, and weight match the paper loaded in the tray?</p>	Go to step 2.	Specify the paper type, texture, and weight from the tray settings to match the paper loaded in the tray.
<p>Step 2 Resend the print job.</p> <p>Does the toner still rub off?</p>	Contact customer support .	The problem is solved.

Toner specks appear on prints

Action	Yes	No
<p>Step 1 a Clean the charger and the printhead lens. b Resend the print job.</p> <p>Do toner specks appear on prints?</p>	Go to step 2.	The problem is solved.
<p>Step 2 Replace the photoconductor unit, and then resend the print job.</p> <p>Do toner specks appear on prints?</p>	Contact customer support .	The problem is solved.

Transparency print quality is poor

Action	Yes	No
<p>Step 1 From the printer control panel, set the paper type in the Paper menu to match the paper loaded in the tray.</p> <p>Is the paper type for the tray set to Transparency?</p>	Go to step 2.	Set the paper type to Transparency.
<p>Step 2 a Check if you are using a recommended type of transparency. b Resend the print job.</p> <p>Is the print quality still poor?</p>	Contact customer support .	The problem is solved.

Uneven print density

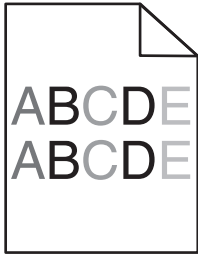

Action	Yes	No
<p>Step 1</p> <p>a Clean the charger and the printhead lens.</p> <p>b Resend the print job.</p> <p>Is the print density uneven?</p>	Go to step 2.	The problem is solved.
<p>Step 2</p> <p>Replace the photoconductor unit, and then resend the print job.</p> <p>Is the print density uneven?</p>	Contact customer support .	The problem is solved.

Vertical voids appear on prints

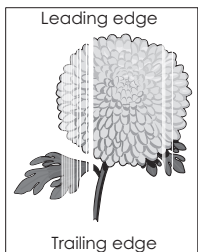

Action	Yes	No
<p>Step 1</p> <p>a Make sure your software program is using a correct fill pattern.</p> <p>b Resend the print job.</p> <p>Do vertical voids appear on prints?</p>	Go to step 2.	The problem is solved.
<p>Step 2</p> <p>a From the control panel, set the paper type and weight in the Paper menu to match the paper loaded in the tray.</p> <p>b Resend the print job.</p> <p>Do vertical voids appear on prints?</p>	Go to step 3.	The problem is solved.

Action	Yes	No
<p>Step 3 Check if you are using a recommended type of paper.</p> <ul style="list-style-type: none"> a Load the specified tray or feeder with a recommended type of paper. b Resend the print job. <p>Do vertical voids appear on prints?</p>	<p>Go to step 4.</p>	<p>The problem is solved.</p>
<p>Step 4 a Remove the photoconductor unit, and then reinstall it.</p> <p>Warning—Potential Damage: Do not expose the photoconductor unit to direct light for more than 10 minutes. Extended exposure to light may cause print quality problems.</p> <ul style="list-style-type: none"> b Resend the print job. <p>Do vertical voids appear on prints?</p>	<p>Go to step 5.</p>	<p>The problem is solved.</p>
<p>Step 5 a Clean the charger and the printhead lens.</p> <ul style="list-style-type: none"> b Resend the print job. <p>Do vertical voids appear on prints?</p>	<p>Go to step 6.</p>	<p>The problem is solved.</p>
<p>Step 6 Replace the photoconductor unit, and then resend the print job.</p> <p>Do vertical voids appear on prints?</p>	<p>Contact customer support.</p>	<p>The problem is solved.</p>

Solving home screen application problems

An application error has occurred

Action	Yes	No
<p>Step 1</p> <p>Check the system log for relevant details.</p> <p>a Open a Web browser, and then type the printer IP address in the address field.</p> <p>If you do not know the IP address of the printer, then you can:</p> <ul style="list-style-type: none"> • View the IP address on the printer home screen. • Print a network setup page or the menu settings pages, and then locate the IP address in the TCP/IP section. <p>Note: An IP address appears as four sets of numbers separated by periods, such as 123.123.123.123.</p> <p>b Click Settings > Apps > Apps Management > System tab > Log.</p> <p>c From the Filter menu, select an application status.</p> <p>d From the Application menu, select an application, and then click Submit.</p> <p>Does an error message appear in the log?</p>	<p>Go to step 2.</p>	<p>Contact customer support.</p>
<p>Step 2</p> <p>Resolve the error.</p> <p>Is the application working now?</p>	<p>The problem is solved.</p>	<p>Contact customer support.</p>

Embedded Web Server does not open

Action	Yes	No
<p>Step 1</p> <p>Make sure the printer IP address is correct.</p> <p>View the printer IP address:</p> <ul style="list-style-type: none"> • From the printer home screen • From the TCP/IP section in the Network/Ports menu • By printing a network setup page or menu settings page, and then finding the TCP/IP section <p>Note: An IP address appears as four sets of numbers separated by periods, such as 123.123.123.123.</p> <p>Is the printer IP address correct?</p>	<p>Go to step 2.</p>	<p>Type the correct printer IP address in the address field of your Web browser.</p> <p>Note: Depending on the network settings, you may need to type “https://” instead of “http://” before the printer IP address to access the Embedded Web Server.</p>

Action	Yes	No
<p>Step 2 Check if the printer is turned on.</p> <p>Is the printer turned on?</p>	Go to step 3.	Turn on the printer.
<p>Step 3 Check if the network connection is working.</p> <p>Is the network connection working?</p>	Go to step 4.	Contact your system support person.
<p>Step 4 Make sure the cable connections to the printer and print server are secure.</p> <p>For more information, see the setup documentation that came with the printer.</p> <p>Are the cable connections to the printer and print server secure?</p>	Go to step 5.	Tighten the cable connection.
<p>Step 5 Temporarily disable the Web proxy servers.</p> <p>Note: Proxy servers may block or restrict you from accessing certain Web sites including the Embedded Web Server.</p> <p>Are the Web proxy servers disabled?</p>	Go to step 6.	Contact your system support person.
<p>Step 6 Access the Embedded Web Server again by typing the correct IP address in the address field.</p> <p>Did the Embedded Web Server open?</p>	The problem is solved.	Contact customer support .

Contacting customer support

When you contact customer support, you will need to be able to describe the problem you are experiencing, the message on the printer display, and the troubleshooting steps you have already taken to find a solution.

You need to know your printer model type and serial number. For more information, see the label at the back of the printer. The serial number is also listed on the menu settings page.

Lexmark has various ways to help you solve your printing problem. Visit the Lexmark Web site at <http://support.lexmark.com>, and then select one of the following:

Tech Library	You can browse our library of manuals, support documentation, drivers, and other downloads to help you solve common problems.
E-mail	You can send an e-mail to the Lexmark team, describing your problem. A service representative will respond and provide you with information to solve your problem.
Live chat	You can chat directly with a service representative. They can work with you to solve your printer problem or provide assistance through Assisted Service where the service representative can remotely connect to your computer through the Internet to troubleshoot problems, install updates, or complete other tasks to help you successfully use your Lexmark product.

Telephone support is also available. In the U.S. or Canada, call 1-800-539-6275. For other countries or regions, visit <http://support.lexmark.com>.

Notices

Product information

Product name:

Lexmark MS911de

Machine type:

4021

Model(s):

230

Edition notice

March 2024

The following paragraph does not apply to any country where such provisions are inconsistent with local law: LEXMARK INTERNATIONAL, INC., PROVIDES THIS PUBLICATION "AS IS" WITHOUT WARRANTY OF ANY KIND, EITHER EXPRESS OR IMPLIED, INCLUDING, BUT NOT LIMITED TO, THE IMPLIED WARRANTIES OF MERCHANTABILITY OR FITNESS FOR A PARTICULAR PURPOSE. Some states do not allow disclaimer of express or implied warranties in certain transactions; therefore, this statement may not apply to you.

This publication could include technical inaccuracies or typographical errors. Changes are periodically made to the information herein; these changes will be incorporated in later editions. Improvements or changes in the products or the programs described may be made at any time.

References in this publication to products, programs, or services do not imply that the manufacturer intends to make these available in all countries in which it operates. Any reference to a product, program, or service is not intended to state or imply that only that product, program, or service may be used. Any functionally equivalent product, program, or service that does not infringe any existing intellectual property right may be used instead. Evaluation and verification of operation in conjunction with other products, programs, or services, except those expressly designated by the manufacturer, are the user's responsibility.

For Lexmark technical support, visit <http://support.lexmark.com>.

For information on supplies and downloads, visit www.lexmark.com.

© 2014 Lexmark International, Inc.

All rights reserved.

GOVERNMENT END USERS

The Software Program and any related documentation are "Commercial Items," as that term is defined in 48 C.F.R. 2.101, "Computer Software" and "Commercial Computer Software Documentation," as such terms are used in 48 C.F.R. 12.212 or 48 C.F.R. 227.7202, as applicable. Consistent with 48 C.F.R. 12.212 or 48 C.F.R. 227.7202-1 through 227.7207-4, as applicable, the Commercial Computer Software and Commercial Software Documentation are licensed to the U.S. Government end users (a) only as Commercial Items and (b) with only those rights as are granted to all other end users pursuant to the terms and conditions herein.

Trademarks

Lexmark, Lexmark with diamond design, MarkNet, and MarkVision are trademarks of Lexmark International, Inc., registered in the United States and/or other countries.

Mac and the Mac logo are trademarks of Apple Inc., registered in the U.S. and other countries.

PCL® is a registered trademark of the Hewlett-Packard Company. PCL is Hewlett-Packard Company’s designation of a set of printer commands (language) and functions included in its printer products. This printer is intended to be compatible with the PCL language. This means the printer recognizes PCL commands used in various application programs, and that the printer emulates the functions corresponding to the commands.

The following terms are trademarks or registered trademarks of these companies:

Albertus	The Monotype Corporation plc
Antique Olive	Monsieur Marcel OLIVE
Apple-Chancery	Apple Computer, Inc.
Arial	The Monotype Corporation plc
CG Times	Based on Times New Roman under license from The Monotype Corporation plc, is a product of Agfa Corporation
Chicago	Apple Computer, Inc.
Clarendon	Linotype-Hell AG and/or its subsidiaries
Eurostile	Nebiolo
Geneva	Apple Computer, Inc.
GillSans	The Monotype Corporation plc
Helvetica	Linotype-Hell AG and/or its subsidiaries
Hoefler	Jonathan Hoefler Type Foundry
ITC Avant Garde Gothic	International Typeface Corporation
ITC Bookman	International Typeface Corporation
ITC Mona Lisa	International Typeface Corporation
ITC Zapf Chancery	International Typeface Corporation
Joanna	The Monotype Corporation plc
Marigold	Arthur Baker
Monaco	Apple Computer, Inc.
New York	Apple Computer, Inc.
Oxford	Arthur Baker
Palatino	Linotype-Hell AG and/or its subsidiaries
Stempel Garamond	Linotype-Hell AG and/or its subsidiaries
Taffy	Agfa Corporation
Times New Roman	The Monotype Corporation plc
Univers	Linotype-Hell AG and/or its subsidiaries

All other trademarks are the property of their respective owners.

AirPrint and the AirPrint logo are trademarks of Apple, Inc.

Federal Communications Commission (FCC) compliance information statement

This product has been tested and found to comply with the limits for a Class A digital device, pursuant to Part 15 of the FCC Rules. Operation is subject to the following two conditions: (1) this device may not cause harmful interference, and (2) this device must accept any interference received, including interference that may cause undesired operation.

The FCC Class A limits are designed to provide reasonable protection against harmful interference when the equipment is operated in a commercial environment. This equipment generates, uses, and can radiate radio frequency energy and, if not installed and used in accordance with the instruction manual, may cause harmful interference to radio communications. Operation of this equipment in a residential area is likely to cause harmful interference, in which case the user will be required to correct the interference at his own expense.

The manufacturer is not responsible for any radio or television interference caused by using other than recommended cables or by unauthorized changes or modifications to this equipment. Unauthorized changes or modifications could void the user's authority to operate this equipment.

Note: To assure compliance with FCC regulations on electromagnetic interference for a Class A computing device, use a properly shielded and grounded cable such as Lexmark part number 1021231 for parallel attach or 1021294 for USB attach. Use of a substitute cable not properly shielded and grounded may result in a violation of FCC regulations.

Licensing notices

All licensing notices associated with this product can be viewed from the CD:\NOTICES directory of the installation software CD.

Noise emission levels

The following measurements were made in accordance with ISO 7779 and reported in conformance with ISO 9296.

Note: Some modes may not apply to your product.

1-meter average sound pressure, dBA	
Printing	54 (one-sided); 55 (two-sided)
Ready	28

Values are subject to change. See www.lexmark.com for current values.

Waste from Electrical and Electronic Equipment (WEEE) directive

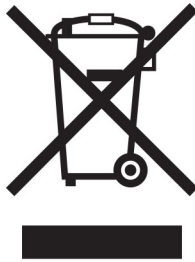

The WEEE logo signifies specific recycling programs and procedures for electronic products in countries of the European Union. We encourage the recycling of our products.

If you have further questions about recycling options, visit the Lexmark Web site at www.lexmark.com for your local sales office phone number.

India E-Waste notice

This product complies with the India E-Waste (Management and Handling) Rules, 2011, which prohibit use of lead, mercury, hexavalent chromium, polybrominated biphenyls, or polybrominated diphenyl ethers in concentrations exceeding 0.1% by weight and 0.01% by weight for cadmium, except for the exemption set in Schedule II of the Rules.

Product disposal

Do not dispose of the printer or supplies in the same manner as normal household waste. Consult your local authorities for disposal and recycling options.

Static sensitivity notice

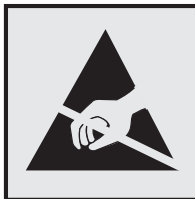

This symbol identifies static-sensitive parts. Do not touch in the areas near these symbols without first touching the metal frame of the printer.

ENERGY STAR

Any Lexmark product bearing the ENERGY STAR® emblem on the product or on a start-up screen is certified to comply with Environmental Protection Agency (EPA) ENERGY STAR requirements as configured when shipped by Lexmark.



Temperature information

Ambient operating temperature	10 to 30°C (50 to 86°F)
Shipping temperature	-10 to 40°C (14 to 104°F)
Storage temperature and relative humidity	-10 to 40°C (14 to 104°F) 15 to 85% RH

Laser notice

The printer is certified in the U.S. to conform to the requirements of DHHS 21 CFR Chapter I, Subchapter J for Class I (1) laser products, and elsewhere is certified as a Class I laser product conforming to the requirements of IEC 60825-1: 2014.

Class I laser products are not considered to be hazardous. The printer contains internally a Class IIIb (3b) laser that is nominally a 15-milliwatt gallium arsenide laser operating in the wavelength of 787–800 nanometers. The laser system and printer are designed so there is never any human access to laser radiation above a Class I level during normal operation, user maintenance, or prescribed service condition.

Laser advisory label

A laser notice label may be affixed to this printer as shown:

DANGER - Invisible laser radiation when cartridges are removed and interlock defeated. Avoid exposure to laser beam.

PERIGO - Radiação a laser invisível será liberada se os cartuchos forem removidos e o lacre rompido. Evite a exposição aos feixes de laser.

Opasnost - Nevidljivo lasersko zračenje kada su kasete uklonjene i poništena sigurnosna veza. Izbjegavati izlaganje zracima.

NEBEZPEČÍ - Když jsou vyjmuty kazety a je odblokována pojistka, ze zařízení je vysíláno neviditelné laserové záření. Nevystavujte se působení laserového paprsku.

FARE - Usynlig laserstråling når patroner fjernes, og spærreanordningen er slået fra. Undgå at blive udsat for laserstrålen.

GEVAAR - Onzichtbare laserstraling wanneer cartridges worden verwijderd en een vergrendeling wordt genegeerd. Voorkom blootstelling aan de laser.

DANGER - Rayonnements laser invisibles lors du retrait des cartouches et du déverrouillage des loquets. Éviter toute exposition au rayon laser.

VAARA - Näkymätöntä lasersäteilyä on varottava, kun värikasetit on poistettu ja lukitus on auki. Vältä lasersäteelle altistumista.

GEFAHR - Unsichtbare Laserstrahlung beim Herausnehmen von Druckkassetten und offener Sicherheitssperre. Laserstrahl meiden.

ΚΙΝΔΥΝΟΣ - Εκκλυση αόρατης ακτινοβολίας laser κατά την αφαίρεση των κασετών και την απασφάλιση της μανδάλωσης. Αποφεύγετε την έκθεση στην ακτινοβολία laser.

VESZÉLY – Nem látható lézersugárzás fordulhat elő a patronok eltávolításakor és a zárószervezet felbontásakor. Kerülje a lézersugárnak való kitettséget.

PERICOLO - Emissione di radiazioni laser invisibili durante la rimozione delle cartucce e del blocco. Evitare l'esposizione al raggio laser.

FARE – Usynlig laserstråling når kassetene tas ut og sperren er satt ut av spill. Unngå eksponering for laserstrålen.

NIEBEZPIECZEŃSTWO - niewidzialne promieniowanie laserowe podczas usuwania kaset i blokady. Należy unikać naświetlenia promieniem lasera.

ОПАСНО! Невидимое лазерное излучение при извлеченных картриджах и снятии блокировки. Избегайте воздействия лазерных лучей.

Pozor – Nebezpečnostvo neviditeľného laserového žiarenia pri odobratých kazetách a odblokovanej poistke. Nevystavujte sa lúčom.

PELIGRO: Se producen radiaciones láser invisibles al extraer los cartuchos con el interbloqueo desactivado. Evite la exposición al haz de láser.

FARA – Osynlig laserstråling när patroner tas ur och spärrmekanismen är upphävd. Undvik exponering för laserstrålen.

危険 - 当移除碳粉盒及互锁失效时会产生看不见的激光辐射, 请避免暴露在激光光束下。

危険 - 移除碳粉匣與安全連續開關失效時會產生看不見的雷射輻射。請避免暴露在雷射光束下。

危険 - カートリッジが取り外され、内部ロックが無効になると、見えないレーザー光が放射されます。このレーザー光に当たらないようにしてください。

Power consumption

Product power consumption

The following table documents the power consumption characteristics of the product.

Note: Some modes may not apply to your product.

Mode	Description	Power consumption (Watts)
Printing	The product is generating hard-copy output from electronic inputs.	910 (one-sided); 830 (two-sided)
Copy	The product is generating hard-copy output from hard-copy original documents.	N/A
Scan	The product is scanning hard-copy documents.	N/A
Ready	The product is waiting for a print job.	190
Sleep Mode	The product is in a high-level energy-saving mode.	2.5
Hibernate	The product is in a low-level energy-saving mode.	0.5
Off	The product is plugged into an electrical outlet, but the power switch is turned off.	0

The power consumption levels listed in the previous table represent time-averaged measurements. Instantaneous power draws may be substantially higher than the average.

Values are subject to change. See www.lexmark.com for current values.

Sleep Mode

This product is designed with an energy-saving mode called *Sleep Mode*. The Sleep Mode saves energy by lowering power consumption during extended periods of inactivity. The Sleep Mode is automatically engaged after this product is not used for a specified period of time, called the *Sleep Mode Timeout*.

Factory default Sleep Mode Timeout for this product (in minutes):	20
---	----

By using the configuration menus, the Sleep Mode Timeout can be modified between 1 minute and 120 minutes. Setting the Sleep Mode Timeout to a low value reduces energy consumption, but may increase the response time of the product. Setting the Sleep Mode Timeout to a high value maintains a fast response, but uses more energy.

Hibernate Mode

This product is designed with an ultra-low power operating mode called *Hibernate mode*. When operating in Hibernate Mode, all other systems and devices are powered down safely.

The Hibernate mode can be entered in any of the following methods:

- Using the Hibernate Timeout
- Using the Schedule Power modes
- Using the Sleep/Hibernate button

Factory default Hibernate Timeout for this product in all countries or regions	3 days
--	--------

The amount of time the printer waits after a job is printed before it enters Hibernate mode can be modified between one hour and one month.

Off mode

If this product has an off mode which still consumes a small amount of power, then to completely stop product power consumption, disconnect the power supply cord from the electrical outlet.

Total energy usage

It is sometimes helpful to calculate the total product energy usage. Since power consumption claims are provided in power units of Watts, the power consumption should be multiplied by the time the product spends in each mode in order to calculate energy usage. The total product energy usage is the sum of each mode's energy usage.

Applicability of Regulation (EU) 2019/2015 and (EU) 2019/2020

Per Commission Regulation (EU) 2019/2015 and (EU) 2019/2020, the light source contained within this product or its component is intended to be used for Image Capture or Image Projection only, and is not intended for use in other applications.

Industry Canada compliance statement

This Class A digital apparatus meets all requirements of the Canadian Interference-Causing Equipment Standard ICES-003.

Avis de conformité aux normes de l'industrie du Canada

Cet appareil numérique de classe A est conforme aux exigences de la norme canadienne relative aux équipements pouvant causer des interférences NMB-003.

Japanese VCCI notice

製品にこのラベルが表示されている場合、
次の要件を満たしています。

この装置は、クラス A 情報技術装置です。この装置を家庭環境で使用すると電波妨害を引き起こすことがあります。この場合には使用者が適切な対策を講ずるよう要求されることがあります。 VCCI-A

この装置は、クラス A 情報技術装置です。この装置を家庭環境で使用すると電波妨害を引き起こすことがあります。この場合には使用者が適切な対策を講ずるよう要求されることがあります。 VCCI-A

European Community (EC) directives conformity

This product is in conformity with the protection requirements of EC Council directives 2004/108/EC, 2006/95/EC, and 2011/65/EU on the approximation and harmonization of the laws of the Member States relating to electromagnetic compatibility, safety of electrical equipment designed for use within certain voltage limits, and on the restrictions of use of certain hazardous substances in electrical and electronic equipment.

The manufacturer of this product is: Lexmark International, Inc., 740 West New Circle Road, Lexington, KY, 40550 USA. The authorized representative is: Lexmark International Technology Hungária Kft., 8 Lechner Ödön fasor, Millennium Tower III, 1095 Budapest HUNGARY, A declaration of conformity to the requirements of the Directives is available upon request from the Authorized Representative.

This product satisfies the Class A limits of EN 55022 and safety requirements of EN 60950-1.

Radio interference notice

Warning

This is a product that complies with the emission requirements of EN55022 Class A limits and immunity requirements of EN55024. This product is not intended to be used in residential/domestic environments.

This is a Class A product. In a domestic environment, this product may cause radio interference, in which case the user may be required to take adequate measures.

Regulatory notices for wireless products

This section contains the following regulatory information pertaining to wireless products that contain transmitters, for example, but not limited to, wireless network cards or proximity card readers.

Modular component notice

This product may contain the following modular component(s):

Lexmark Regulatory Type/LEX-M01-005; FCC ID: IYLLEXM01005; Industry Canada IC: 2376A-M01005

Exposure to radio frequency radiation

The radiated output power of this device is far below the radio frequency exposure limits of the FCC and other regulatory agencies. A minimum separation of 20 cm (8 inches) must be maintained between the antenna and any persons for this device to satisfy the RF exposure requirements of the FCC and other regulatory agencies.

Industry Canada (Canada)

Under Industry Canada regulations, this radio transmitter may only operate using an antenna of a type and maximum (or lesser) gain approved for the transmitter by Industry Canada. To reduce potential radio interference to other users, the antenna type and its gain should be so chosen that the equivalent isotropically radiated power (EIRP) is not more than that necessary for successful communication.

This device complies with Industry Canada license-exempt RSS standards. Operation is subject to the following two conditions: (1) this device may not cause interference, and (2) this device must accept any interference, including interference that may cause undesired operation of the device.

To prevent radio interference to the licensed service, this device is intended to be operated indoors and away from windows to provide maximum shielding.

Industrie Canada (Canada)

Selon la réglementation d'Industrie Canada, l'émetteur radio ne fonctionner qu'avec une antenne dont le type et le gain maximal (ou inférieur) ont été approuvés par Industrie Canada. Pour réduire les interférences radio potentielles auprès d'autres utilisateurs, le type d'antenne et son gain doivent être choisis de telle sorte que la puissance isotrope rayonnée équivalente (PIRE) ne soit pas supérieure à ce qui est nécessaire pour assurer la réussite de la communication.

Cet appareil est conforme aux normes RSS exemptes de licence d'Industrie Canada. Son fonctionnement est soumis aux deux conditions suivantes : (1) cet appareil ne doit pas causer d'interférences et (2) il doit accepter toutes les interférences, y compris les interférences pouvant entraîner un fonctionnement indésirable.

Pour éviter toute interférence radio au service sous licence, cet appareil est destiné à être utilisé à l'intérieur et à l'écart des fenêtres afin d'assurer une protection maximale.

Notice to users in the European Union

Products bearing the CE mark are in conformity with the protection requirements of EC Council directives 2004/108/EC, 2006/95/EC, 1999/5/EC, and 2011/65/EU on the approximation and harmonization of the laws of the Member States relating to electromagnetic compatibility, safety of electrical equipment designed for use within certain voltage limits, radio equipment and telecommunications terminal equipment, and on the restrictions of use of certain hazardous substances in electrical and electronic equipment.

Compliance is indicated by the CE marking.



The manufacturer of this product is: Lexmark International, Inc., 740 West New Circle Road, Lexington, KY, 40550 USA. The authorized representative is: Lexmark International Technology Hungária Kft., 8 Lechner Ödön fasor, Millennium Tower III, 1095 Budapest HUNGARY, A declaration of conformity to the requirements of the Directives is available upon request from the Authorized Representative.

This product satisfies the Class A limits of EN 55022 and safety requirements of EN 60950-1.

Products equipped with 2.4GHz Wireless LAN option are in conformity with the protection requirements of EC Council directives 2004/108/EC, 2006/95/EC, and 1999/5/EC on the approximation and harmonization of the laws of the Member States relating to electromagnetic compatibility, safety of electrical equipment designed for use within certain voltage limits and on radio equipment and telecommunications terminal equipment.

Compliance is indicated by the CE marking.



Operation is allowed in all EU and EFTA countries, but is restricted to indoor use only.

The manufacturer of this product is: Lexmark International, Inc., 740 West New Circle Road, Lexington, KY, 40550 USA. The authorized representative is: Lexmark International Technology Hungária Kft., 8 Lechner Ödön fasor, Millennium Tower III, 1095 Budapest HUNGARY, A declaration of conformity to the requirements of the Directives is available upon request from the Authorized Representative.

This product may be used in the countries indicated in the table below.

AT	BE	BG	CH	CY	CZ	DE	DK	EE
EL	ES	FI	FR	HR	HU	IE	IS	IT
LI	LT	LU	LV	MT	NL	NO	PL	PT
RO	SE	SI	SK	TR	UK			

Česky	Společnost Lexmark International, Inc. tímto prohlašuje, že výrobek tento výrobek je ve shodě se základními požadavky a dalšími příslušnými ustanoveními směrnice 1999/5/ES.
Dansk	Lexmark International, Inc. erklærer herved, at dette produkt overholder de væsentlige krav og øvrige relevante krav i direktiv 1999/5/EF.
Deutsch	Hiermit erklärt Lexmark International, Inc., dass sich das Gerät dieses Gerät in Übereinstimmung mit den grundlegenden Anforderungen und den übrigen einschlägigen Bestimmungen der Richtlinie 1999/5/EG befindet.
Ελληνική	ΜΕ ΤΗΝ ΠΑΡΟΥΣΑ Η LEXMARK INTERNATIONAL, INC. ΔΗΛΩΝΕΙ ΟΤΙ ΑΥΤΟ ΤΟ ΠΡΟΪΟΝ ΣΥΜΜΟΡΦΩΝΕΤΑΙ ΠΡΟΣ ΤΙΣ ΟΥΣΙΩΔΕΙΣ ΑΠΑΙΤΗΣΕΙΣ ΚΑΙ ΤΙΣ ΛΟΙΠΕΣ ΣΧΕΤΙΚΕΣ ΔΙΑΤΑΞΕΙΣ ΤΗΣ ΟΔΗΓΙΑΣ 1999/5/ΕΚ.
English	Hereby, Lexmark International, Inc., declares that this type of equipment is in compliance with the essential requirements and other relevant provisions of Directive 1999/5/EC.

Español	Por medio de la presente, Lexmark International, Inc. declara que este producto cumple con los requisitos esenciales y cualesquiera otras disposiciones aplicables o exigibles de la Directiva 1999/5/CE.
Eesti	Käesolevaga kinnitab Lexmark International, Inc., et seade see toode vastab direktiivi 1999/5/EÜ põhinõuetele ja nimetatud direktiivist tulenevatele muudele asjakohastele sätetele.
Suomi	Lexmark International, Inc. vakuuttaa täten, että tämä tuote on direktiivin 1999/5/EY oleellisten vaatimusten ja muiden sitä koskevien direktiivin ehtojen mukainen.
Français	Par la présente, Lexmark International, Inc. déclare que l'appareil ce produit est conforme aux exigences fondamentales et autres dispositions pertinentes de la directive 1999/5/CE.
Magyar	Alulírott, Lexmark International, Inc. nyilatkozom, hogy a termék megfelel a vonatkozó alapvető követelményeknek és az 1999/5/EC irányelv egyéb előírásainak.
Íslenska	Hér með lýsir Lexmark International, Inc. yfir því að þessi vara er í samræmi við grunnkröfur og aðrar kröfur, sem gerðar eru í tilskipun 1999/5/EC.
Italiano	Con la presente Lexmark International, Inc. dichiara che questo prodotto è conforme ai requisiti essenziali ed alle altre disposizioni pertinenti stabilite dalla direttiva 1999/5/CE.
Latviski	Ar šo Lexmark International, Inc. deklarē, ka šis izstrādājums atbilst Direktīvas 1999/5/EK būtiskajām prasībām un citiem ar to saistītajiem noteikumiem.
Lietuvių	Šiuo Lexmark International, Inc. deklaruoja, kad šis produktas atitinka esminius reikalavimus ir kitas 1999/5/EB direktyvos nuostatas.
Malti	Bil-preżenti, Lexmark International, Inc., jiddikjara li dan il-prodott huwa konformi mal-ħtiġijiet essenzjali u ma dispozizzjonijiet oħrajn rilevanti li jinsabu fid-Direttiva 1999/5/KE.
Nederlands	Hierbij verklaart Lexmark International, Inc. dat het toestel dit product in overeenstemming is met de essentiële eisen en de andere relevante bepalingen van richtlijn 1999/5/EG.
Norsk	Lexmark International, Inc. erklærer herved at dette produktet er i samsvar med de grunnleggende krav og øvrige relevante krav i direktiv 1999/5/EF.
Polski	Niniejszym Lexmark International, Inc. oświadcza, że niniejszy produkt jest zgodny z zasadniczymi wymogami oraz pozostałymi stosownymi postanowieniami Dyrektywy 1999/5/EC.
Português	A Lexmark International Inc. declara que este produto está conforme com os requisitos essenciais e outras disposições da Diretiva 1999/5/CE.
Slovensky	Lexmark International, Inc. týmto vyhlasuje, že tento produkt spĺňa základné požiadavky a všetky príslušné ustanovenia smernice 1999/5/ES.
Slovensko	Lexmark International, Inc. izjavlja, da je ta izdelek v skladu z bistvenimi zahtevami in ostalimi relevantnimi določili direktive 1999/5/ES.
Svenska	Härmed intygar Lexmark International, Inc. att denna produkt står i överensstämmelse med de väsentliga egenskapskrav och övriga relevanta bestämmelser som framgår av direktiv 1999/5/EG.

STATEMENT OF LIMITED WARRANTY FOR LEXMARK LASER PRINTERS, LEXMARK LED PRINTERS, AND LEXMARK MULTIFUNCTION LASER PRINTERS

STATEMENT OF LIMITED WARRANTY FOR LEXMARK LASER PRINTERS, LEXMARK LED PRINTERS, AND LEXMARK MULTIFUNCTION LASER PRINTERS

Lexmark International, Inc., Lexington, KY

This limited warranty applies to the United States and Canada. For customers outside the U.S., refer to the country-specific warranty information that came with your product.

This limited warranty applies to this product only if it was originally purchased for your use, and not for resale, from Lexmark or a Lexmark Remarketer, referred to in this statement as “Remarketer.”

Limited warranty

Lexmark warrants that this product:

- Is manufactured from new parts, or new and serviceable used parts, which perform like new parts
- Is, during normal use, free from defects in material and workmanship

If this product does not function as warranted during the warranty period, contact a Remarketer or Lexmark for repair or replacement (at Lexmark's option).

If this product is a feature or option, this statement applies only when that feature or option is used with the product for which it was intended. To obtain warranty service, you may be required to present the feature or option with the product.

If you transfer this product to another user, warranty service under the terms of this statement is available to that user for the remainder of the warranty period. You should transfer proof of original purchase and this statement to that user.

Limited warranty service

The warranty period starts on the date of original purchase as shown on the purchase receipt and ends 12 months later provided that the warranty period for any supplies and for any maintenance items included with the printer shall end earlier if it, or its original contents, are substantially used up, depleted, or consumed. Fuser Units, Transfer/Transport Units, Paper Feed items, if any, and any other items for which a Maintenance Kit is available are substantially consumed when the printer displays a “Life Warning” or “Scheduled Maintenance” message for such item.

To obtain warranty service you may be required to present proof of original purchase. You may be required to deliver your product to the Remarketer or Lexmark, or ship it prepaid and suitably packaged to a Lexmark designated location. You are responsible for loss of, or damage to, a product in transit to the Remarketer or the Lexmark designated location.

When warranty service involves the exchange of a product or part, the item replaced becomes the property of the Remarketer or Lexmark. The replacement may be a new or repaired item.

The replacement item assumes the remaining warranty period of the original product.

Replacement is not available to you if the product you present for exchange is defaced, altered, in need of a repair not included in warranty service, damaged beyond repair, or if the product is not free of all legal obligations, restrictions, liens, and encumbrances.

As part of your warranty service and/or replacement, Lexmark may update the firmware in your printer to the latest version. Firmware updates may modify printer settings and cause counterfeit and/or unauthorized products, supplies, parts, materials (such as toners and inks), software, or interfaces to stop working. Authorized use of genuine Lexmark products will not be impacted.

Before you present this product for warranty service, remove all print cartridges, programs, data, and removable storage media (unless directed otherwise by Lexmark).

For further explanation of your warranty alternatives and the nearest Lexmark authorized servicer in your area contact Lexmark on the World Wide Web.

Remote technical support is provided for this product throughout its warranty period. For products no longer covered by a Lexmark warranty, technical support may not be available or only be available for a fee.

Extent of limited warranty

Lexmark does not warrant uninterrupted or error-free operation of any product or the durability or longevity of prints produced by any product.

Warranty service does not include repair of failures caused by:

- Modification or unauthorized attachments
- Accidents, misuse, abuse or use inconsistent with Lexmark user's guides, manuals, instructions or guidance
- Unsuitable physical or operating environment
- Maintenance by anyone other than Lexmark or a Lexmark authorized servicer
- Operation of a product beyond the limit of its duty cycle
- Use of printing media outside of Lexmark specifications
- Refurbishment, repair, refilling or remanufacture by a third party of products, supplies or parts
- Products, supplies, parts, materials (such as toners and inks), software, or interfaces not furnished by Lexmark

TO THE EXTENT PERMITTED BY APPLICABLE LAW, NEITHER LEXMARK NOR ITS THIRD PARTY SUPPLIERS OR REMARKETERS MAKE ANY OTHER WARRANTY OR CONDITION OF ANY KIND, WHETHER EXPRESS OR IMPLIED, WITH RESPECT TO THIS PRODUCT, AND SPECIFICALLY DISCLAIM THE IMPLIED WARRANTIES OR CONDITIONS OF MERCHANTABILITY, FITNESS FOR A PARTICULAR PURPOSE, AND SATISFACTORY QUALITY. ANY WARRANTIES THAT MAY NOT BE DISCLAIMED UNDER APPLICABLE LAW ARE LIMITED IN DURATION TO THE WARRANTY PERIOD. NO WARRANTIES, EXPRESS OR IMPLIED, WILL APPLY AFTER THIS PERIOD. ALL INFORMATION, SPECIFICATIONS, PRICES, AND SERVICES ARE SUBJECT TO CHANGE AT ANY TIME WITHOUT NOTICE.

Limitation of liability

Your sole remedy under this limited warranty is set forth in this document. For any claim concerning performance or nonperformance of Lexmark or a Remarketer for this product under this limited warranty, you may recover actual damages up to the limit set forth in the following paragraph.

Lexmark's liability for actual damages from any cause whatsoever will be limited to the amount you paid for the product that caused the damages. This limitation of liability will not apply to claims by you for bodily injury or damage to real property or tangible personal property for which Lexmark is legally liable. **IN NO EVENT WILL LEXMARK BE LIABLE FOR ANY LOST PROFITS, LOST SAVINGS, INCIDENTAL DAMAGE, OR OTHER ECONOMIC OR CONSEQUENTIAL DAMAGES.** This is true even if you advise Lexmark or a Remarketer of the possibility of such damages. Lexmark is not liable for any claim by you based on a third party claim.

This limitation of remedies also applies to claims against any Suppliers and Remarketers of Lexmark. Lexmark's and its Suppliers' and Remarketers' limitations of remedies are not cumulative. Such Suppliers and Remarketers are intended beneficiaries of this limitation.

Additional rights

Some states do not allow limitations on how long an implied warranty lasts, or do not allow the exclusion or limitation of incidental or consequential damages, so the limitations or exclusions contained above may not apply to you.

This limited warranty gives you specific legal rights. You may also have other rights that vary from state to state.

Patent acknowledgment

The use of this product or service is subject to the reasonable, non-discriminatory terms in the Intellectual Property Rights (IPR) Disclosure of Certicom Corp. at the IETF for Elliptic Curve Cryptography (ECC) Cipher Suites for Transport Layer Security (TLS) implemented in the product or service.

The use of this product or service is subject to the reasonable, non-discriminatory terms in the Intellectual Property Rights (IPR) Disclosure of Certicom Corp. at the IETF for TLS Elliptic Curve Cipher Suites with SHA-256/382 and AES Galois Counter Mode (GCM) implemented in the product or service.

The use of this product or service is subject to the reasonable, non-discriminatory terms in the Intellectual Property Rights (IPR) Disclosure of Certicom Corp. at the IETF for TLS Suite B Profile for Transport Layer Security (TLS) implemented in the product or service.

The use of this product or service is subject to the reasonable, non-discriminatory terms in the Intellectual Property Rights (IPR) Disclosure of Certicom Corp. at the IETF for Addition of the Camellia Cipher Suites to Transport Layer Security (TLS) implemented in the product or service.

The use of certain patents in this product or service is subject to the reasonable, non-discriminatory terms in the Intellectual Property Rights (IPR) Disclosure of Certicom Corp. at the IETF for AES-CCM ECC Cipher Suites for TLS implemented in the product or service.

The use of this product or service is subject to the reasonable, non-discriminatory terms in the Intellectual Property Rights (IPR) Disclosure of Certicom Corp. at the IETF for IKE and IKEv2 Authentication Using the Elliptic Curve Digital Signature Algorithm (ECDSA) implemented in the product or service.

The use of this product or service is subject to the reasonable, non-discriminatory terms in the Intellectual Property Rights (IPR) Disclosure of Certicom Corp. at the IETF for Suite B Cryptographic Suites for IPsec implemented in the product or service.

The use of this product or service is subject to the reasonable, non-discriminatory terms in the Intellectual Property Rights (IPR) Disclosure of Certicom Corp. at the IETF for Algorithms for Internet Key Exchange version 1 (IKEv1) implemented in the product or service.

Index

Numerics

300K maintenance kit
ordering 139

Symbols

[x] maintenance kit very low
[80.xy] 196

[x]-page jam, clear manual feeder.
[200.xx] 166

[x]-page jam, detach the
3000-sheet tray and open door
F. [24y.xx] 174

[x]-page jam, open door C and
clear all jammed media.
[2yy.xx] 167

[x]-page jam, open door D and
clear all jammed media.
[24y.xx] 171

[x]-page jam, open door H and
rotate knob H6 clockwise. Leave
paper in bin. [426.xx–428.xx] 184

[x]-page jam, open doors G, H,
and J and clear jammed paper.
Leave paper in bin. [400–
402] 177

[x]-page jam, press latch to
access area G and clear jammed
staples. Leave paper in bin.
[402.93] 182

[x]-page jam, press latch to
access area G. Leave paper in
bin. [40y.xx] 180

[x]-page jam, slide the
3000-sheet tray and open door
C. [2yy.xx] 169

[x]-page jam, slide the
3000-sheet tray and open door
D. [24y.xx] 172

A

accessing the controller
board 22

accessing the Embedded Web
Server 18

Active NIC menu 82

adding hardware options
print driver 41

adding internal options
print driver 41

adjusting printer display
brightness 126

adjusting Sleep mode 126

adjusting toner darkness 65

AppleTalk menu 87

attaching cables 40

available internal options 22

avoiding jams 59

avoiding paper jams 164

B

Background and Idle Screen
using 19

Bin Setup menu 80

buttons, control panel 14

buttons, touch screen
using 16

C

cables
Ethernet 40
USB 40

canceling a print job
from the computer 70
from the printer control
panel 69

cannot open Embedded Web
Server 238

card stock
tips 54

Cartridge low [88.xy] 190

Cartridge nearly low [88.xy] 190

Cartridge very low [88.xy] 190

Change [paper source] to
[custom string] load
[orientation] 190

Change [paper source] to
[custom type name] load
[orientation] 190

Change [paper source] to [paper
size] load [orientation] 190

Change [paper source] to [paper
type] [paper size] load
[orientation] 191

changing port settings
internal solutions port 45

charger
cleaning 133

checking an unresponsive
printer 203

checking status of parts and
supplies 137

checking the status of parts and
supplies 137

checking the virtual display
using the Embedded Web
Server 162

checking virtual display
using the Embedded Web
Server 162

cleaning
exterior of the printer 133

cleaning the charger 133

cleaning the printer 133

cleaning the printhead lens 133

Close door [x] 191

Complex page, some data may
not have printed [39] 191

confidential data
information on securing 130

confidential jobs
modifying print settings 68

confidential print jobs 67

Confidential Print menu 97

Configuration change, some held
jobs were not restored [57] 191

configuration information
wireless network 42

Configure MP menu 75

configuring
multiple printers 162

configuring port settings 45

configuring supply
notifications 163

connecting the printer to an
outlet 10

connecting to a wireless network
using PIN (Personal
Identification Number)
method 43

using Push Button Configuration
method 43

using the Embedded Web
Server 44

- using wireless setup wizard 43
- conservation settings
 - brightness, adjusting 126
 - conserving supplies 124
 - Eco-Mode 125
 - Hibernate mode 125
 - Sleep Mode 126
- conserving supplies 124
- contacting customer support 239
- control panel
 - factory defaults, restoring 163
 - parts 14
 - using 14
- control panel, printer
 - indicator light 14
 - Sleep button light 14
- controller board
 - accessing 22
- Custom Bin Names menu 79
- Custom Names menu 79
- custom paper type name
 - assigning 53
 - creating 52
- Custom Types menu 79
- customer support
 - contacting 239

D

- Default Source menu 72
- Defective flash detected [51] 191
- device and network settings information
 - erasing 129
- directory list
 - printing 69
- Disk full [62] 192
- Disk must be formatted for use in this device 192
- display troubleshooting
 - printer display is blank 205
- display, control panel 14
- display, printer control panel
 - adjusting brightness 126
- disposing of printer hard disk 128
- documents, printing
 - from a computer 65
- door C
 - paper jams, clearing 167, 169
- door D
 - paper jams, clearing 171, 172

E

- Eco-Mode setting 125
- Eco-Settings
 - about 20
- Edit Security Setups menu 95
- embedded solutions information
 - erasing 129
- Embedded Web Server
 - accessing 18
 - adjusting brightness 126
 - checking the status of parts 137
 - checking the status of supplies 137
 - copying settings to other printers 162
 - modifying confidential print settings 68
 - problem accessing 238
- Embedded Web Server—Security: Administrator's Guide
 - where to find 130
- emission
 - notices 243, 247, 248, 249
- Empty the hole punch box 192
- emptying the hole punch box 136
- encrypting the printer hard disk 130
- envelopes
 - tips on using 54
- environmental settings
 - conserving supplies 124
 - Eco-Mode 125
 - Hibernate mode 125
 - printer display brightness, adjusting 126
 - Sleep Mode 126
- Erase Temporary Data Files menu 97
- erasing hard disk memory 129
- erasing non-volatile memory 129
- erasing volatile memory 129
- Error reading USB drive. Remove USB. 192
- Error reading USB hub. Remove hub. 192
- Ethernet network
 - preparing to set up for Ethernet printing 41
- Ethernet port 40

- Ethernet setup
 - preparing for an 41
- exhaust filter
 - replacing 151
- exporting a configuration
 - using the Embedded Web Server 21
- exterior of the printer
 - cleaning 133

F

- factory defaults
 - restoring 163
- FCC notices 243, 249
- feet
 - stabilizing 35
- finding more information about the printer 9
- finding printer IP address 18
- finding the IP address of the computer 18
- finisher
 - supported paper sizes 62
 - supported paper types 62
 - supported paper weights 62
- Finishing menu 112
- firmware card 22
- firmware, updating
 - using Embedded Web Server 132
 - using the control panel 131
- flash drive
 - printing from 65
- flash drives
 - supported file types 67
- font sample list
 - printing 69
- Forms and Favorites
 - setting up 19

G

- General Settings menu 100
- green settings
 - Eco-Mode 125
 - Hibernate mode 125

H

- hardware options, adding print driver 41

held jobs 67
 printing from a Macintosh computer 68
 printing from Windows 68
held print jobs
 printing from a Macintosh computer 68
 printing from Windows 68
Help menu 122
Hibernate mode
 using 125
hiding icons on the home screen 19
hole punch box
 emptying 136
Home button 14
home screen
 buttons, understanding 15
 hiding icons 19
 showing icons 19
home screen buttons
 understanding 15
HTML menu 121

I

icons on the home screen
 hiding 19
 showing 19
Image menu 122
importing a configuration
 using the Embedded Web Server 21
Incorrect paper size, open [paper source] [34] 192
indicator light 14
individual settings information
 erasing 129
Insert hole punch box 193
Insert Tray [x] 193
installing a memory card 25
installing an optional card 26
installing hardware options
 order of installation 34
installing printer 41
installing printer hard disk 29
installing the optional trays 35
Insufficient memory for Flash Memory Defragment operation [37] 193
Insufficient memory to collate job [37] 193

Insufficient memory to support Resource Save feature [35] 193
Insufficient memory, some Held Jobs were deleted [37] 193
Insufficient memory, some held jobs will not be restored [37] 193
Insufficient space between paper stacks in Tray 3 194
internal options 22
internal options, adding
 print driver 41
internal print server
 troubleshooting 206
Internal Solutions Port
 troubleshooting 207
Internal Solutions Port (ISP)
 installing 27
IP address of computer
 finding 18
IP address, printer
 finding 18
IPv6 menu 86

J

jams
 avoiding 164
 locating jam areas 165
 locations 165
 numbers 165
jams, clearing
 in 3000-sheet tray 174
 in door C 174
 in door F 174
 in multipurpose feeder 166
Job Accounting menu 115

K

keypad 14

L

labels, paper
 tips 55
letterhead
 loading, multipurpose feeder 55
 loading, trays 55
linking trays 52, 53
Load [paper source] with [custom string] [paper orientation] 194

Load [paper source] with [custom type name] [paper orientation] 194
Load [paper source] with [paper size] [paper orientation] 194
Load [paper source] with [paper type] [paper size] [paper orientation] 194
Load Multipurpose Feeder with [custom string] [paper orientation] 194
Load Multipurpose Feeder with [custom type name] [paper orientation] 195
Load Multipurpose Feeder with [paper size] [paper orientation] 195
Load Multipurpose Feeder with [paper type] [paper size] [paper orientation] 195
Load staples 195
Load staples [G11, G12] 196
loading letterhead
 paper orientation 55
loading the multipurpose feeder 49
loading trays 47
lock, security 128

M

maintenance counter, resetting 160
memory
 types installed on printer 128
memory card 22
 installing 25
Memory full [38] 196
menu settings
 loading on multiple printers 162
menu settings page
 printing 46
menus
 Active NIC 82
 AppleTalk 87
 Bin Setup 80
 Confidential Print 97
 Configure MP 75
 Custom Bin Names 79
 Custom Names 79
 Custom Types 79
 Default Source 72
 Edit Security Setups 95

- Erase Temporary Data Files 97
 - Finishing 112
 - General Settings 100
 - Help 122
 - HTML 121
 - Image 122
 - IPv6 86
 - Job Accounting 115
 - list of 71
 - Miscellaneous 96
 - Network [x] 83
 - Network Card 84
 - Network Reports 84
 - Paper Loading 77
 - Paper Size/Type 72
 - Paper Texture 76
 - Parallel [x] 89
 - PCL Emul 118
 - PDF 117
 - PostScript 118
 - Print Settings 108
 - Quality 114
 - Reports 81
 - Security Audit Log 98
 - Serial [x] 92
 - Set Date and Time 98
 - Setup 110
 - SMTP Setup 94
 - Standard Network 83
 - Standard USB 88
 - Substitute Size 76
 - TCP/IP 85
 - Universal Setup 79
 - Utilities 116
 - Wireless 87
 - XPS 117
 - Miscellaneous menu 96
 - mobile device
 - printing from 67
 - moving the printer 10, 161
 - multipurpose feeder
 - loading 49
- N**
- Network [x] menu 83
 - Network [x] software error [54] 196
 - Network Card menu 84
 - Network Reports menu 84
 - network setup page
 - printing 46
 - noise emission levels 243
 - non-volatile memory 128
 - erasing 129
 - Not enough free space in flash memory for resources [52] 196
 - notices 242, 243, 244, 245, 246, 247, 248, 249, 250
 - number of remaining pages
 - estimate 137
- O**
- Open door H and remove paper from beneath area H10 197
 - optional 2 x 500-sheet tray
 - installing 35
 - optional 2500-sheet tray
 - installing 35
 - optional card
 - installing 26
 - optional trays
 - installing 35
 - options
 - firmware cards 22
 - Internal Solutions Port (ISP) 27
 - memory card 22, 25
 - printer hard disk, installing 29
 - printer hard disk, removing 33
 - ordering
 - 300K maintenance kit 139
 - photoconductor unit 138
 - staple cartridges 139
 - ordering supplies
 - toner cartridge 138
 - waste toner bottle 138
 - ozone filter
 - replacing 151
- P**
- paper
 - characteristics 56
 - letterhead 57
 - preprinted forms 57
 - recycled 57
 - selecting 57
 - storing 56, 59
 - unacceptable 57
 - using recycled 124
 - Paper changes needed 197
 - paper characteristics 56
 - paper feed troubleshooting
 - message remains after jam is cleared 210
 - paper jams
 - avoiding 164
 - paper jams, clearing
 - door C 167, 169
 - door D 171, 172
 - in 3000-sheet tray 174
 - in door C 174
 - in door F 174
 - in multipurpose feeder 166
 - Paper Loading menu 77
 - paper size
 - setting 47
 - Paper Size/Type menu 72
 - paper sizes
 - supported 59
 - Paper Texture menu 76
 - paper type
 - setting 47
 - paper types
 - supported by printer 61
 - paper weights
 - supported by printer 61
 - Parallel [x] menu 89
 - Parallel port [x] disabled [56] 197
 - parts
 - checking status 137
 - checking, from printer control panel 137
 - checking, using the Embedded Web Server 137
 - storing 139
 - using genuine Lexmark 138
 - parts, ordering
 - 300K maintenance kit 139
 - PCL Emul menu 118
 - PDF menu 117
 - Personal Identification Number method
 - using 43
 - Photoconductor low [84.xy] 197
 - photoconductor unit
 - ordering 138
 - replacing 140
 - Photoconductor very low [84.xy] 197
 - port settings
 - configuring 45
 - PostScript menu 118
 - power cord socket 40
 - preparing to set up the printer on an Ethernet network 41

- print driver
 - hardware options, adding 41
- print irregularities 223
- print job
 - canceling from the computer 70
- print quality
 - replacing a photoconductor unit 140
- print quality troubleshooting
 - blank pages 227
 - characters have jagged edges 218
 - clipped pages or images 218
 - gray background on prints 220
 - horizontal voids appear on prints 220
 - print irregularities 223
 - print is too dark 224
 - print is too light 226
 - printer is printing solid black pages 228
 - repeating defects appear on prints 229
 - shadow images appear on prints 230
 - skewed print 231
 - streaked horizontal lines appear on prints 231
 - streaked vertical lines 232
 - toner fog or background shading appears on prints 234
 - toner rubs off 234
 - toner specks appear on prints 235
 - transparency print quality is poor 235
 - uneven print density 236
 - white streaks 236
- print quality, troubleshooting
 - cleaning the charger 133
 - cleaning the printhead lens 133
- Print Settings menu 108
- print troubleshooting
 - envelope seals when printing 212
 - error reading flash drive 212
 - held jobs do not print 211
 - incorrect characters print 213
 - incorrect margins on prints 221
 - jammed pages are not reprinted 209
 - job prints from wrong tray 213
 - job prints on wrong paper 213
 - jobs do not print 216
 - Large jobs do not collate 214
 - multiple-language PDF files do not print 214
 - paper curl 222
 - paper frequently jams 209
 - print job takes longer than expected 215
 - tray linking does not work 217
 - unexpected page breaks occur 217
- printer 41
 - basic model 11
 - connecting to an outlet 10
 - fully configured 11
 - minimum clearances 10
 - moving 10, 161
 - selecting a location 10
 - shipping 161
- printer configurations 11
- printer control panel
 - adjusting brightness 126
 - indicator light 14
 - Sleep button light 14
- Printer had to restart. Last job may be incomplete. 197
- printer hard disk
 - disposing of 128
 - encrypting 130
 - installing 29
 - removing 33
- printer hard disk encryption 130
- printer hard disk memory
 - erasing 129
- printer information
 - where to find 9
- printer IP address
 - finding 18
- printer is printing blank pages 227
- printer messages
 - [x] maintenance kit very low [80.xy] 196
 - [x]-page jam, clear manual feeder. [200.xx] 166
 - [x]-page jam, detach the 3000-sheet tray and open door F. [24y.xx] 174
 - [x]-page jam, open door C and clear all jammed media. [2yy.xx] 167
 - [x]-page jam, open door D and clear all jammed media. [24y.xx] 171
 - [x]-page jam, open door H and rotate knob H6 clockwise. Leave paper in bin. [426.xx–428.xx] 184
 - [x]-page jam, open doors G, H, and J and clear jammed paper. Leave paper in bin. [400–402] 177
 - [x]-page jam, press latch to access area G and clear jammed staples. Leave paper in bin. [402.93] 182
 - [x]-page jam, press latch to access area G. Leave paper in bin. [40y.xx] 180
 - [x]-page jam, slide the 3000-sheet tray and open door C. [2yy.xx] 169
 - [x]-page jam, slide the 3000-sheet tray and open door D. [24y.xx] 172
- Cartridge low [88.xy] 190
- Cartridge nearly low [88.xy] 190
- Cartridge very low [88.xy] 190
- Change [paper source] to [custom string] load [orientation] 190
- Change [paper source] to [custom type name] load [orientation] 190
- Change [paper source] to [paper size] load [orientation] 190
- Change [paper source] to [paper type] [paper size] load [orientation] 191
- Close door [x] 191
- Complex page, some data may not have printed [39] 191
- Configuration change, some held jobs were not restored [57] 191
- Defective flash detected [51] 191
- Disk full [62] 192
- Disk must be formatted for use in this device 192

- Disk near full. Securely clearing disk space. 192
- Empty the hole punch box 192
- Error reading USB drive.
 - Remove USB. 192
- Error reading USB hub. Remove hub. 192
- Incorrect paper size, open [paper source] [34] 192
- Insert hole punch box 193
- Insert Tray [x] 193
- Insufficient memory for Flash Memory Defragment operation [37] 193
- Insufficient memory to collate job [37] 193
- Insufficient memory to support Resource Save feature [35] 193
- Insufficient memory, some Held Jobs were deleted [37] 193
- Insufficient memory, some held jobs will not be restored [37] 193
- Insufficient space between paper stacks in Tray 3 194
- Load [paper source] with [custom string] [paper orientation] 194
- Load [paper source] with [custom type name] [paper orientation] 194
- Load [paper source] with [paper size] [paper orientation] 194
- Load [paper source] with [paper type] [paper size] [paper orientation] 194
- Load Multipurpose Feeder with [custom string] [paper orientation] 194
- Load Multipurpose Feeder with [custom type name] [paper orientation] 195
- Load Multipurpose Feeder with [paper size] [paper orientation] 195
- Load Multipurpose Feeder with [paper type] [paper size] [paper orientation] 195
- Load staples 195
- Load staples [G11, G12] 196
- Memory full [38] 196
- Network [x] software error [54] 196
- Not enough free space in flash memory for resources [52] 196
- Open door H and remove paper from beneath area H10 197
- Paper changes needed 197
- Parallel port [x] disabled [56] 197
- Photoconductor low [84.xy] 197
- Photoconductor very low [84.xy] 197
- Printer had to restart. Last job may be incomplete. 197
- Reinstall missing or unresponsive cartridge [31.xy] 197
- Reinstall missing or unresponsive photoconductor [31.xy] 198
- Remove defective disk [61] 198
- Remove packaging material, [area name] 198
- Remove packaging material, open door C, remove metal clips 198
- Remove paper from [linked set bin name] 198
- Remove paper from all bins 198
- Remove paper from bin [x] 198
- Remove paper from standard output bin 198
- Replace [x] maintenance kit, 0 estimated pages remain [80.xy] 199
- Replace cartridge, 0 estimated pages remain [88.xy] 199
- Replace cartridge, printer region mismatch [42.xy] 199
- Replace missing cartridge [31.xy] 200
- Replace missing photoconductor [31.xy] 199
- Replace missing waste toner bottle [82.xy] 199
- Replace paper pick rollers in [paper source], use parts and instructions in tray 1 or tray 2 compartment [80] 200
- Replace photoconductor, 0 pages remain [84.xy] 200
- Replace unsupported cartridge [32.xy] 200
- Replace unsupported photoconductor [32.xy] 200
- Replace waste toner bottle [82.xy] 200
- Restore held jobs? 200
- Serial port [x] disabled [56] 201
- SMTP server not set up. Contact system administrator. 201
- Some held jobs were not restored 201
- Standard network software error [54] 201
- Standard USB port disabled [56] 201
- Supply needed to complete job 201
- The device is operating in safe mode. Some print options may be disabled or provide unexpected results. 202
- Too many flash options installed [58] 202
- Too many trays attached [58] 202
- Tray [x] paper size unsupported 202
- Unformatted flash detected [53] 202
- Unsupported disk 202
- Unsupported option in slot [x] [55] 203
- Unsupported USB hub, please remove 192
- Waste toner bottle nearly full [82.xy] 203
- Weblink server not set up. Contact system administrator. 203
- printer options troubleshooting
 - internal option is not detected 205
 - internal print server 206
 - Internal Solutions Port 207
 - tray problems 207
 - USB/parallel interface card 208
- printer problems, solving basic 203
- printer security information on 130

printhead lens
 cleaning 133
 printing
 canceling, from the printer
 control panel 69
 directory list 69
 font sample list 69
 forms 65
 from a computer 65
 from a mobile device 67
 from flash drive 65
 menu settings page 46
 network setup page 46
 printing a directory list 69
 printing a font sample list 69
 printing a menu settings page 46
 printing a network setup
 page 46
 printing forms 65
 printing from a flash drive 65
 printing from a mobile device 67
 printing held jobs
 from a Macintosh computer 68
 from Windows 68
 publications
 where to find 9
 Push Button Configuration
 method
 using 43

Q

Quality menu 114

R

recycled paper
 using 57, 124
 recycling
 Lexmark packaging 127
 Lexmark products 126
 toner cartridges 127
 Reinstall missing or unresponsive
 cartridge [31.xy] 197
 Reinstall missing or unresponsive
 photoconductor [31.xy] 198
 Remote Operator Panel
 setting up 21
 Remove defective disk [61] 198
 Remove packaging material,
 [area name] 198
 Remove packaging material,
 open door C, remove metal
 clips 198
 Remove paper from [linked set
 bin name] 198
 Remove paper from all bins 198
 Remove paper from bin [x] 198
 Remove paper from standard
 output bin 198
 removing printer hard disk 33
 repeat print jobs 67
 printing from a Macintosh
 computer 68
 printing from Windows 68
 repeating defects appear on
 prints 229
 Replace [x] maintenance kit, 0
 estimated pages remain
 [80.xy] 199
 Replace cartridge, 0 estimated
 pages remain [88.xy] 199
 Replace cartridge, printer region
 mismatch [42.xy] 199
 Replace missing cartridge
 [31.xy] 200
 Replace missing photoconductor
 [31.xy] 199
 Replace missing waste toner
 bottle [82.xy] 199
 Replace paper pick rollers in
 [paper source], use parts and
 instructions in tray 1 or tray 2
 compartment [80] 200
 Replace photoconductor, 0
 pages remain [84.xy] 200
 Replace unsupported cartridge
 [32.xy] 200
 Replace unsupported
 photoconductor [32.xy] 200
 Replace waste toner bottle
 [82.xy] 200
 replacing parts
 pick, feed, separator rollers 153
 transfer module 156
 transfer roller 159
 replacing supplies
 staple cartridge in booklet
 finisher 144
 staple cartridge in staple
 finisher 142
 staple cartridge in staple, hole
 punch finisher 146

 toner cartridge 147
 waste toner bottle 149
 replacing the exhaust filter 151
 replacing the ozone filter 151
 replacing the pick, feed, and
 separator rollers 153
 replacing the staple cartridge in
 the booklet finisher 144
 replacing the staple cartridge in
 the staple finisher 142
 replacing the staple cartridge in
 the staple, hole punch
 finisher 146
 replacing the toner cartridge 147
 replacing the transfer
 module 156
 replacing the transfer roller 159
 replacing the waste toner
 bottle 149
 reports
 viewing 162
 Reports menu 81
 reserve print jobs
 printing from a Macintosh
 computer 68
 printing from Windows 68
 resetting the maintenance
 counter 160
 Restore held jobs? 200
 restoring factory default
 settings 163
 rollers
 replacing 153

S

safety information 6, 7, 8
 security
 modifying confidential print
 settings 68
 Security Audit Log menu 98
 security lock 128
 security settings information
 erasing 129
 security Web page
 printer security information 130
 selecting a location for the
 printer 10
 selecting paper 57
 Serial [x] menu 92
 Serial port [x] disabled [56] 201
 serial printing
 setting up 45

- Set Date and Time menu 98
 - setting
 - paper size 47
 - paper type 47
 - TCP/IP address 85
 - setting the Universal paper size 47
 - setting up serial printing 45
 - Setup menu 110
 - shipping the printer 161
 - showing icons on the home screen 19
 - Sleep button 14
 - Sleep Mode
 - adjusting 126
 - SMTP server not set up. Contact system administrator. 201
 - SMTP Setup menu 94
 - Some held jobs were not restored 201
 - stabilizing feet 35
 - Standard Network menu 83
 - Standard network software error [54] 201
 - Standard USB menu 88
 - Standard USB port disabled [56] 201
 - staple cartridge in booklet finisher
 - replacing 144
 - staple cartridge in staple finisher
 - replacing 142
 - staple cartridge in staple, hole punch finisher
 - replacing 146
 - staple cartridges
 - ordering 139
 - statement of volatility 128
 - status of parts
 - checking 137
 - status of supplies
 - checking 137
 - Stop or Cancel button 14
 - storing
 - paper 59
 - parts 139
 - supplies 139
 - storing print jobs 67
 - streaked horizontal lines appear on prints 231
 - streaked vertical lines appear on prints 232
 - streaks appear 236
 - Substitute Size menu 76
 - supplies
 - checking status 137
 - checking, from printer control panel 137
 - checking, using the Embedded Web Server 137
 - conserving 124
 - storing 139
 - using genuine Lexmark 138
 - using recycled paper 124
 - supplies, ordering
 - photoconductor unit 138
 - staple cartridges 139
 - toner cartridge 138
 - waste toner bottle 138
 - Supply needed to complete job 201
 - supply notifications
 - configuring 163
 - supported flash drives 67
 - supported paper sizes 59
 - finisher 62
 - supported paper types
 - finisher 62
 - printer 61
 - supported paper weights
 - finisher 62
 - printer 61
- T**
- TCP/IP menu 85
 - The device is operating in safe mode. Some print options may be disabled or provide unexpected results. 202
 - tips
 - card stock 54
 - labels, paper 55
 - on using envelopes 54
 - transparencies 56
 - tips on using envelopes 54
 - tips on using letterhead 55
 - toner cartridge
 - ordering 138
 - replacing 147
 - toner cartridges
 - recycling 127
 - toner darkness
 - adjusting 65
 - Too many flash options installed [58] 202
 - Too many trays attached [58] 202
 - touch screen
 - buttons, using 16
 - transfer module
 - replacing 156
 - transfer roller
 - replacing 159
 - transparencies
 - tips 56
 - Tray [x] paper size unsupported 202
 - trays
 - linking 52, 53
 - loading 47
 - unlinking 52, 53
 - troubleshooting
 - an application error has occurred 238
 - cannot open Embedded Web Server 238
 - checking an unresponsive printer 203
 - contacting customer support 239
 - solving basic printer problems 203
 - troubleshooting, display
 - printer display is blank 205
 - troubleshooting, paper feed
 - message remains after jam is cleared 210
 - troubleshooting, print
 - envelope seals when printing 212
 - error reading flash drive 212
 - held jobs do not print 211
 - incorrect characters print 213
 - incorrect margins on prints 221
 - jammed pages are not reprinted 209
 - job prints from wrong tray 213
 - job prints on wrong paper 213
 - jobs do not print 216
 - Large jobs do not collate 214
 - multiple-language PDF files do not print 214
 - paper curl 222
 - paper frequently jams 209

- print job takes longer than expected 215
- tray linking does not work 217
- unexpected page breaks occur 217
- troubleshooting, print quality
 - blank pages 227
 - characters have jagged edges 218
 - clipped pages or images 218
 - gray background on prints 220
 - horizontal voids appear on prints 220
 - print irregularities 223
 - print is too dark 224
 - print is too light 226
 - printer is printing solid black pages 228
 - repeating defects appear on prints 229
 - shadow images appear on prints 230
 - skewed print 231
 - streaked horizontal lines appear on prints 231
 - streaked vertical lines 232
 - toner fog or background shading appears on prints 234
 - toner rubs off 234
 - toner specks appear on prints 235
 - transparency print quality is poor 235
 - uneven print density 236
 - white streaks on a page 236
- troubleshooting, printer options
 - internal option is not detected 205
 - internal print server 206
 - Internal Solutions Port 207
 - tray problems 207
 - USB/parallel interface card 208

U

- understanding the home screen 15
- uneven print density 236
- Unformatted flash detected [53] 202
- Universal paper size setting 47
- Universal Setup menu 79

- unlinking trays 52, 53
- Unsupported option in slot [x] [55] 203
- Unsupported USB hub, please remove 192
- updating firmware
 - using Embedded Web Server 132
 - using the control panel 131
- USB port 40
- USB/parallel interface card
 - troubleshooting 208
- using Forms and Favorites 65
- using Hibernate mode 125
- using recycled paper 124
- using the control panel 14
- using the touch-screen buttons 16
- Utilities menu 116

V

- verify print jobs 67
 - printing from a Macintosh computer 68
 - printing from Windows 68
- vertical voids appear 236
- viewing reports 162
- virtual display
 - checking, using Embedded Web Server 162
- voids appear 236
- volatile memory 128
 - erasing 129
- volatility
 - statement of 128

W

- waste toner bottle
 - ordering 138
 - replacing 149
- Waste toner bottle nearly full [82.xy] 203
- Weblink server not set up. Contact system administrator. 203
- Wireless menu 87
- wireless network
 - configuration information 42

- wireless network setup
 - using the Embedded Web Server 44
- wireless setup wizard
 - using 43

X

- XPS menu 117