



Lexmark™

MB2338, MX321 MFPs

User's Guide

March 2024

www.lexmark.com

Machine type:

7017

Models:

276, 278

Contents

- Safety information..... 6**
 - Conventions..... 6
 - Product statements..... 6

- Learning about the printer..... 10**
 - Finding information about the printer..... 10
 - Finding the printer serial number..... 11
 - Selecting a location for the printer..... 12
 - Printer configurations..... 13
 - Attaching cables..... 14
 - Using the control panel..... 15
 - Understanding the status of the power button and indicator light..... 16

- Loading paper and specialty media..... 17**
 - Setting the size and type of the specialty media..... 17
 - Configuring Universal paper settings..... 17
 - Loading trays..... 17
 - Loading the multipurpose feeder..... 19
 - Linking trays..... 20

- Paper support..... 21**
 - Supported paper sizes..... 21
 - Supported paper types..... 23
 - Supported paper weights..... 23

- Printing..... 24**
 - Printing from a computer..... 24
 - Printing from a mobile device..... 24
 - Printing a font sample list..... 25

- Copying..... 26**
 - Using the automatic document feeder and scanner glass..... 26
 - Making copies..... 26
 - Copying photos..... 26
 - Copying on letterhead..... 27

Copying on both sides of the paper..... 27

Reducing or enlarging copies..... 27

Collating copies..... 27

Placing separator sheets between copies..... 28

Copying multiple pages onto a single sheet..... 28

Creating a copy shortcut..... 28

E-mailing..... 29

Using the automatic document feeder and scanner glass..... 29

Configuring the e-mail SMTP settings..... 29

Creating an e-mail shortcut..... 37

Sending an e-mail using a shortcut number..... 37

Faxing..... 38

Setting up the printer to fax..... 38

Using the automatic document feeder and scanner glass..... 45

Sending a fax..... 45

Scheduling a fax..... 46

Creating a fax destination shortcut..... 47

Changing the fax resolution..... 47

Adjusting the fax darkness..... 47

Printing a fax log..... 47

Blocking junk faxes..... 48

Holding faxes..... 48

Forwarding a fax..... 48

Scanning..... 50

Using the automatic document feeder and scanner glass..... 50

Scanning to a computer..... 50

Creating an FTP shortcut..... 51

Creating a network folder shortcut..... 52

Scanning to an FTP server using a shortcut number..... 52

Understanding the printer menus..... 53

Menu map..... 53

Device..... 54

Print..... 63

Paper..... 71

Copy..... 73

Fax..... 76

E-mail..... 86

FTP..... 93

Network/Ports..... 98

Security..... 110

Reports..... 115

Help..... 116

Troubleshooting..... 117

Printing the Menu Settings Page..... 117

Securing the printer..... 118

Locating the security slot..... 118

Erasing printer memory..... 118

Restoring factory default settings..... 119

Statement of Volatility..... 119

Maintaining the printer..... 120

Networking..... 120

Cleaning printer parts..... 123

Ordering parts and supplies..... 126

Replacing parts and supplies..... 129

Moving the printer..... 141

Saving energy and paper..... 142

Recycling..... 143

Clearing jams..... 144

Avoiding jams..... 144

Identifying jam locations..... 145

Paper jam in door A..... 146

Paper jam in the rear door..... 150

Paper jam in the standard bin..... 151

Paper jam in the duplex unit..... 152

Paper jam in trays..... 153

Paper jam in the multipurpose feeder..... 153

Paper jam in the automatic document feeder..... 154

Troubleshooting.....	156
Print quality problems.....	156
Printing problems.....	157
Network connection problems.....	185
Internal option problems.....	187
Issues with supplies.....	188
Paper feed problems.....	189
E-mailing problems.....	192
Faxing problems.....	193
Scanning problems.....	199
Contacting customer support.....	203
Upgrading and migrating.....	204
Hardware.....	204
Software.....	209
Firmware.....	211
Notices.....	214
Index.....	230

Safety information

Conventions





Note: A *note* identifies information that could help you.

Warning: A *warning* identifies something that could damage the product hardware or software.







WARNING (in full capitals): A *WARNING* indicates a risk of death or serious injury if not avoided.









CAUTION: A *caution* indicates a potentially hazardous situation that could injure you.







Different types of caution statements include:

-  **CAUTION—POTENTIAL INJURY:** Indicates a risk of injury.
-  **CAUTION—SHOCK HAZARD:** Indicates a risk of electrical shock.
-  **CAUTION—HOT SURFACE:** Indicates a risk of burn if touched.
-  **CAUTION—TIPPING HAZARD:** Indicates a crush hazard.
-  **CAUTION—PINCH HAZARD:** Indicates a risk of being caught between moving parts.

Product statements

-  **CAUTION—POTENTIAL INJURY:** To avoid the risk of fire or electrical shock, connect the power cord to an appropriately rated and properly grounded electrical outlet that is near the product and easily accessible.
-  **CAUTION—POTENTIAL INJURY:** To avoid the risk of fire or electrical shock, use only the power cord provided with this product or the manufacturer's authorized replacement.
-  **CAUTION—POTENTIAL INJURY:** Do not use this product with extension cords, multioutlet power strips, multioutlet extenders, or UPS devices. The power capacity of these types of accessories can be easily overloaded by a laser printer and may result in a risk of fire, property damage, or poor printer performance.
-  **CAUTION—POTENTIAL INJURY:** Only a Lexmark Inline Surge Protector that is properly connected between the printer and the power cord provided with the printer may be used with this product. The use of non-Lexmark surge protection devices may result in a risk of fire, property damage, or poor printer performance.
-  **CAUTION—POTENTIAL INJURY:** To reduce the risk of fire, use only a 26 AWG or larger telecommunications (RJ-11) cord when connecting this product to the public switched telephone network. For users in Australia, the cord must be approved by the Australian Communications and Media Authority.
-  **CAUTION—SHOCK HAZARD:** To avoid the risk of electrical shock, do not place or use this product near water or wet locations.

-  **CAUTION—SHOCK HAZARD:** To avoid the risk of electrical shock, do not set up this product or make any electrical or cabling connections, such as the power cord, fax feature, or telephone, during a lightning storm.
-  **CAUTION—POTENTIAL INJURY:** Do not cut, twist, bind, crush, or place heavy objects on the power cord. Do not subject the power cord to abrasion or stress. Do not pinch the power cord between objects such as furniture and walls. If any of these things happen, a risk of fire or electrical shock results. Inspect the power cord regularly for signs of such problems. Remove the power cord from the electrical outlet before inspecting it.
-  **CAUTION—SHOCK HAZARD:** To avoid the risk of electrical shock, make sure that all external connections (such as Ethernet and telephone system connections) are properly installed in their marked plug-in ports.
-  **CAUTION—SHOCK HAZARD:** To avoid the risk of electrical shock, if you are accessing the controller board or installing optional hardware or memory devices sometime after setting up the printer, then turn the printer off, and unplug the power cord from the electrical outlet before continuing. If you have any other devices attached to the printer, then turn them off as well, and unplug any cables going into the printer.
-  **CAUTION—SHOCK HAZARD:** To avoid the risk of electrical shock, do not use the fax feature during a lightning storm.
-  **CAUTION—SHOCK HAZARD:** To avoid the risk of electrical shock when cleaning the exterior of the printer, unplug the power cord from the electrical outlet and disconnect all cables from the printer before proceeding.
-  **CAUTION—POTENTIAL INJURY:** If the printer weight is greater than 20 kg (44 lb), then it may require two or more people to lift it safely.
-  **CAUTION—POTENTIAL INJURY:** When moving the printer, follow these guidelines to avoid personal injury or printer damage:
- Make sure that all doors and trays are closed.
 - Turn off the printer, and then unplug the power cord from the electrical outlet.
 - Disconnect all cords and cables from the printer.
 - If the printer has separate floor-standing optional trays or output options attached to it, then disconnect them before moving the printer.
 - If the printer has a caster base, then carefully roll it to the new location. Use caution when passing over thresholds and breaks in flooring.
 - If the printer does not have a caster base but is configured with optional trays or output options, then remove the output options and lift the printer off the trays. Do not try to lift the printer and any options at the same time.
 - Always use the handholds on the printer to lift it.
 - Any cart used to move the printer must have a surface able to support the full footprint of the printer.
 - Any cart used to move the hardware options must have a surface able to support the dimensions of the options.
 - Keep the printer in an upright position.
 - Avoid severe jarring movements.
 - Make sure that your fingers are not under the printer when you set it down.
 - Make sure that there is adequate clearance around the printer.

-  **CAUTION—TIPPING HAZARD:** Installing one or more options on your printer or MFP may require a caster base, furniture, or other feature to prevent instability causing possible injury. For more information on supported configurations, see www.lexmark.com/multifunctionprinters.
-  **CAUTION—TIPPING HAZARD:** To reduce the risk of equipment instability, load each tray separately. Keep all other trays closed until needed.
-  **CAUTION—HOT SURFACE:** The inside of the printer might be hot. To reduce the risk of injury from a hot component, allow the surface to cool before touching it.
-  **CAUTION—PINCH HAZARD:** To avoid the risk of a pinch injury, use caution in areas marked with this label. Pinch injuries may occur around moving parts, such as gears, doors, trays, and covers.
-  **CAUTION—POTENTIAL INJURY:** This product uses a laser. Use of controls or adjustments or performance of procedures other than those specified in the *User's Guide* may result in hazardous radiation exposure.
-  **CAUTION—POTENTIAL INJURY:** The lithium battery in this product is not intended to be replaced. There is a danger of explosion if a lithium battery is incorrectly replaced. Do not recharge, disassemble, or incinerate a lithium battery. Discard used lithium batteries according to the manufacturer's instructions and local regulations.



WARNING

- **INGESTION HAZARD:** This product contains a button cell or coin battery.
- **DEATH** or serious injury can occur if ingested.
- A swallowed button cell or coin battery can cause **Internal Chemical Burns** in as little as **2 hours**.
- **KEEP** new and used batteries **OUT OF REACH of CHILDREN**.
- **Seek immediate medical attention** if a battery is suspected to be swallowed or inserted inside any part of the body.



Remove and immediately recycle or dispose of used batteries according to local regulations and keep away from children. Do not dispose of batteries in household trash or incinerate. Even used batteries may cause severe injury or death. Call a local poison control center for treatment information.

Battery type: CR6821

Nominal battery voltage: 3V

Do not force discharge, recharge, disassemble, heat above 60°C (140°F), or incinerate. Doing so may result in injury due to venting, leakage, or explosion resulting in chemical burns.

This product is designed, tested, and approved to meet strict global safety standards with the use of specific manufacturer's components. The safety features of some parts may not always be obvious. The manufacturer is not responsible for the use of other replacement parts.

Refer service or repairs, other than those described in the user documentation, to a service representative.

This product uses a printing process that heats the print media, and the heat may cause the media to release emissions. You must understand the section in your operating instructions that discusses the guidelines for selecting print media to avoid the possibility of harmful emissions.

This product may produce small amounts of ozone during normal operation, and may be equipped with a filter designed to limit ozone concentrations to levels well below the recommended exposure limits. To avoid high

ozone concentration levels during extensive usage, install this product in a well-ventilated area and replace the ozone and exhaust filters if instructed to do so in the product maintenance instructions. If there are no references to filters in the product maintenance instructions, then there are no filters requiring replacement for this product.

SAVE THESE INSTRUCTIONS.

Learning about the printer

Finding information about the printer

What are you looking for?	Find it here
Initial setup instructions	See the setup documentation that came with the printer.
<ul style="list-style-type: none"> • Printer software • Print or fax driver • Printer firmware • Utility 	Go to www.lexmark.com/downloads , search for your printer model, and then in the Type menu, select the driver, firmware, or utility that you need.
<ul style="list-style-type: none"> • Selecting and storing paper and specialty media • Loading paper • Configuring printer settings • Viewing and printing documents and photos • Configuring the printer on a network • Caring for and maintaining the printer • Troubleshooting and solving problems 	<p>Information Center—Go to https://infoserve.lexmark.com.</p> <p>How-to videos—Go to https://infoserve.lexmark.com/idv/.</p> <p>Help Menu Pages—Access the guides on the printer firmware, or go to http://support.lexmark.com.</p> <p>Touch Screen Guide—Go to http://support.lexmark.com.</p>
Setting up and configuring the accessibility features of your printer	<i>Lexmark Accessibility Guide</i> —Go to http://support.lexmark.com .
Help information for using the printer software	<p>Help for Microsoft Windows or Macintosh operating systems—Open a printer software program or application, and then click Help.</p> <p>Click  to view context-sensitive information.</p> <p>Notes:</p> <ul style="list-style-type: none"> • Help is automatically installed with the printer software. • Depending on the operating system, the printer software is either in the printer program folder or on the desktop.

What are you looking for?	Find it here
<ul style="list-style-type: none"> • Documentation • Live chat support • E-mail support • Voice support 	<p>Go to http://support.lexmark.com.</p> <p>Note: Select your country or region, and then select your product to view the appropriate support site.</p> <p>Support contact information for your country or region can be found on the website or on the printed warranty that came with the printer.</p> <p>Have the following information ready when you contact customer support:</p> <ul style="list-style-type: none"> • Place and date of purchase • Machine type and serial number <p>For more information, see “Finding the printer serial number” on page 11.</p>
<ul style="list-style-type: none"> • Safety information • Regulatory information • Warranty information • Environmental information 	<p>Warranty information varies by country or region:</p> <ul style="list-style-type: none"> • In the U.S.—See the Statement of Limited Warranty included with the printer, or go to http://support.lexmark.com. • In other countries and regions—See the printed warranty that came with the printer. <p><i>Product Information Guide</i>—See the documentation that came with the printer or go to http://support.lexmark.com.</p>

Finding the printer serial number

- 1 Open the front door.

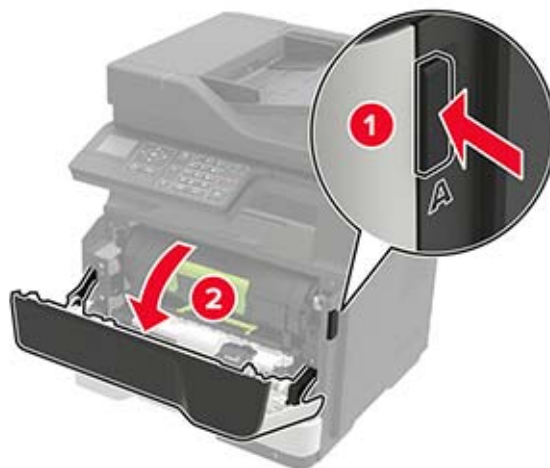

- 2 Locate the printer serial number behind the front door.

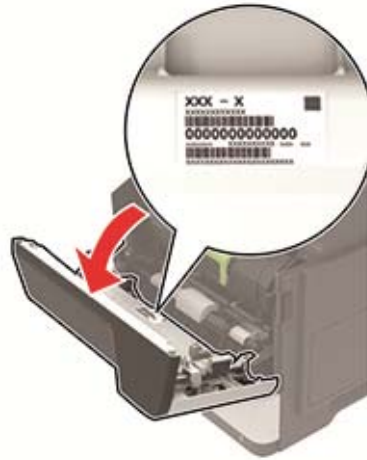

Selecting a location for the printer

- Leave enough room to open trays, covers, and doors and to install hardware options.
- Set up the printer near an electrical outlet.

⚠ CAUTION—POTENTIAL INJURY: To avoid the risk of fire or electrical shock, connect the power cord to an appropriately rated and properly grounded electrical outlet that is near the product and easily accessible.

⚠ CAUTION—SHOCK HAZARD: To avoid the risk of electrical shock, do not place or use this product near water or wet locations.

- Make sure that airflow in the room meets the latest revision of the ASHRAE 62 standard or the CEN Technical Committee 156 standard.
- Provide a flat, sturdy, and stable surface.
- Keep the printer:
 - Clean, dry, and free of dust
 - Away from stray staples and paper clips
 - Away from the direct airflow of air conditioners, heaters, or ventilators
 - Free from direct sunlight and humidity extremes
- Observe the recommended temperatures and avoid fluctuations.

Ambient temperature	10 to 32°C (50 to 90°F)
Storage temperature	0 to 40°C (32 to 104°F)

- Allow the following recommended amount of space around the printer for proper ventilation:

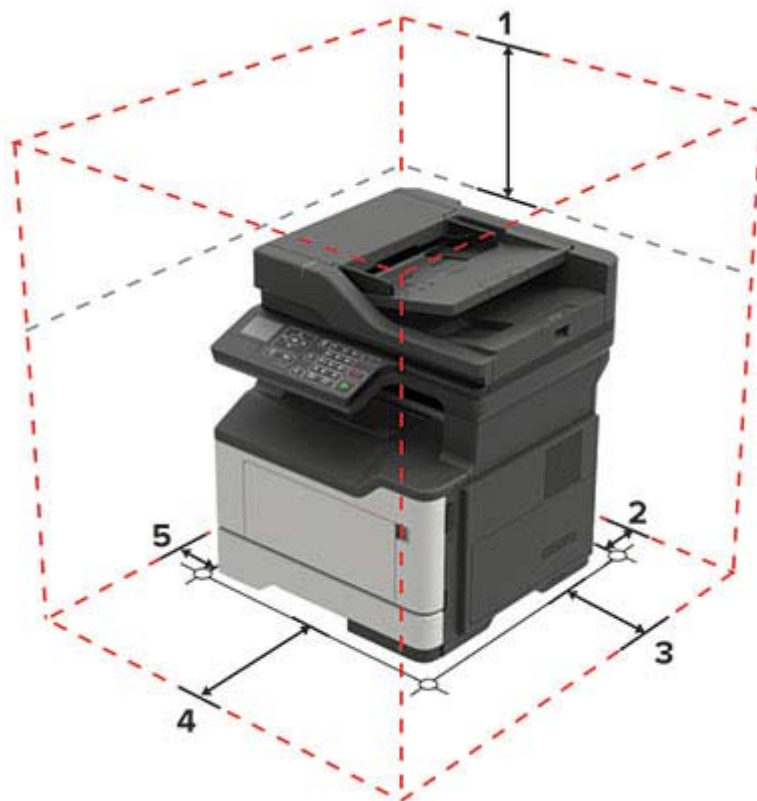

1	Top	540 mm (21 in.)
2	Rear	203 mm (8 in.)
3	Right side	305 mm (12 in.)
4	Front	510 mm (20 in.) Note: The minimum space needed in front of the printer is 76 mm (3 in.).
5	Left side	203 mm (8 in.)

Printer configurations

CAUTION—TIPPING HAZARD: Installing one or more options on your printer or MFP may require a caster base, furniture, or other feature to prevent instability causing possible injury. For more information on supported configurations, see www.lexmark.com/multifunctionprinters.

CAUTION—TIPPING HAZARD: To reduce the risk of equipment instability, load each tray separately. Keep all other trays closed until needed.

You can configure your printer by adding optional 250- or 550-sheet trays. For more information, see [“Installing optional trays” on page 208](#).



1	Control panel
2	Automatic document feeder (ADF)
3	Standard bin
4	Controller board access cover
5	Standard 250-sheet tray
6	Optional 250- or 550-sheet tray
7	Multipurpose feeder
8	Door A

Attaching cables

⚠ CAUTION—SHOCK HAZARD: To avoid the risk of electrical shock, do not set up this product or make any electrical or cabling connections, such as the power cord, fax feature, or telephone, during a lightning storm.

⚠ CAUTION—POTENTIAL INJURY: To avoid the risk of fire or electrical shock, connect the power cord to an appropriately rated and properly grounded electrical outlet that is near the product and easily accessible.

⚠ CAUTION—POTENTIAL INJURY: To avoid the risk of fire or electrical shock, use only the power cord provided with this product or the manufacturer's authorized replacement.

⚠ CAUTION—POTENTIAL INJURY: To reduce the risk of fire, use only a 26 AWG or larger telecommunications (RJ-11) cord when connecting this product to the public switched telephone network. For users in Australia, the cord must be approved by the Australian Communications and Media Authority.

Warning—Potential Damage: To avoid loss of data or printer malfunction, do not touch the USB cable, any wireless network adapter, or the printer in the areas shown while actively printing.



	Use the	To
1	Power cord socket	Connect the printer to a properly grounded electrical outlet.
2	Ethernet port	Connect the printer to a network.
3	LINE port	Connect the printer to an active telephone line through a standard wall jack (RJ-11), DSL filter, or VoIP adapter, or any other adapter that allows you to access the telephone line to send and receive faxes.
4	USB printer port	Connect the printer to a computer.

Using the control panel

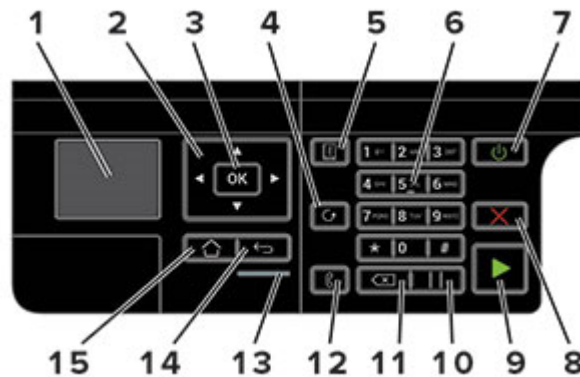

	Use the	To
1	Display	View printing options, printer status, and error messages.
2	Arrow buttons	Scroll through the menus or move between screens and menu options.

	Use the	To
3	Select button	<ul style="list-style-type: none"> Select menu options. Save the settings.
4	Redial button	View the last number dialed.
5	Address book button	View the stored shortcuts.
6	Numeric keypad	Enter numbers or symbols in an input field.
7	Sleep button	Enable Sleep mode. Note: To enable Sleep mode, press the button twice.
8	Stop or Cancel button	Stop the current printer task.
9	Start button	Start a printer task, depending on which mode is selected.
10	Pause button	Place a dial pause in a fax number.
11	Backspace button	Move the cursor backward and delete a character in an input field.
12	Fax button	Send faxes.
13	Indicator light	Check the printer status.
14	Back button	Return to the previous screen.
15	Home button	Go to the home screen.

Understanding the status of the power button and indicator light

Indicator light	Printer status
Off	The printer is off or in Hibernate mode.
Blue	The printer is ready or processing data.
Red	The printer requires user intervention.

Power button light	Printer status
Off	The printer is off, ready, or processing data.
Solid amber	The printer is in Sleep mode.
Blinking amber	The printer is in Hibernate mode.

Loading paper and specialty media

Setting the size and type of the specialty media

1 From the control panel, navigate to:

 > Settings >  > Paper >  > Tray Configuration >  > Paper Size/Type > 

2 Select a paper source, and then configure the size and type of the specialty media.

Configuring Universal paper settings

1 From the control panel, navigate to:

 > Settings >  > Paper >  > Media Configuration >  > Universal Setup > 

2 Select **Portrait Width** or **Portrait Height**, and then press .

3 Adjust the settings, and then press .

Loading trays

 **CAUTION—TIPPING HAZARD:** To reduce the risk of equipment instability, load each tray separately. Keep all other trays closed until needed.

1 Remove the tray.

Note: To avoid paper jams, do not remove trays while the printer is busy.



- 2** Adjust the paper guides to match the size of the paper that you are loading.

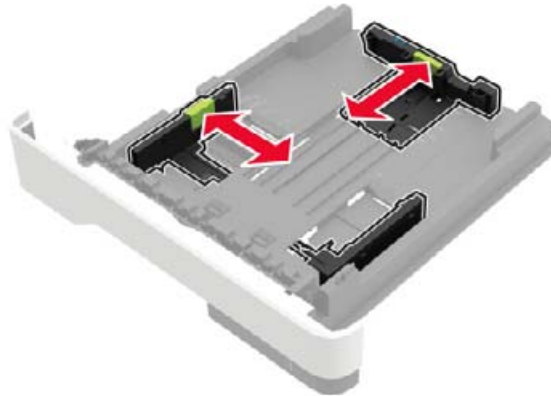

- 3** Flex, fan, and align the paper edges before loading.



- 4** Load the paper stack with the printable side facedown, and then make sure that the side guides fit snugly against the paper.

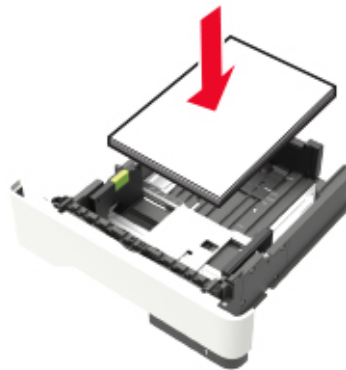

Notes:

- Load letterhead facedown with the top edge of the sheet toward the front of the tray for one-sided printing.
- Load letterhead faceup with the bottom edge of the sheet toward the front of the tray for two-sided printing.
- Do not slide paper into the tray.
- To avoid paper jams, make sure that the stack height is below the maximum paper fill indicator.

- 5** Insert the tray.

If necessary, set the paper size and paper type from the control panel to match the paper loaded.

Loading the multipurpose feeder

1 Open the multipurpose feeder.



2 Adjust the guide to match the size of the paper that you are loading.



3 Flex, fan, and align the paper edges before loading.



4 Load paper with the printable side faceup.

Notes:

- Load letterhead faceup with the top edge of the sheet toward the front of the tray for one-sided printing.
- Load letterhead facedown with the bottom edge of the sheet toward the front of the tray for two-sided printing.

- Load envelopes with the flap facedown on the left side.
- Load European envelopes with the flap facedown and entering the printer first.

Warning—Potential Damage: Do not use envelopes with stamps, clasps, snaps, windows, coated linings, or self-stick adhesives.

5 From the control panel, set the paper size and paper type to match the paper loaded.

Linking trays

1 From the control panel, navigate to:

Settings > **OK** > **Paper** > **OK** > **Tray Configuration** > **OK** > **Paper Size/Type** > **OK**

2 Set the same paper size and paper type for the trays that you are linking.

3 From the control panel, navigate to:

Settings > **OK** > **Device** > **OK** > **Maintenance** > **OK** > **Configuration Menu** > **OK** > **Tray Configuration** > **OK**

4 Set Tray Linking to **Automatic**.

To unlink trays, make sure that no trays have the same paper size and paper type settings.

Warning—Potential Damage: The temperature of the fuser varies according to the specified paper type. To avoid printing issues, match the paper type setting in the printer with the paper loaded in the tray.

Paper support

Supported paper sizes

Paper size	Tray	Multipurpose feeder	Two-sided printing	ADF	Scanner glass
A4 210 x 297 mm (8.3 x 11.7 in.)	✓	✓	✓	✓	✓
A5 210 x 148 mm (8.3 x 5.8 in.)	✓	✓	X	✓	✓
A5 LEF¹ 148 x 210 mm (5.8 x 8.3 in.)	✓	✓	X	✓	✓
A6¹ 105 x 148 mm (4.1 x 5.8 in.)	✓	✓	X	✓	✓
JIS B5 182 x 257 mm (7.2 x 10.1 in.)	✓	✓	X	✓	✓
Oficio (Mexico) 216 x 340 mm (8.5 x 13.4 in.)	✓	✓	✓	✓	✓
Hagaki 100 x 148 mm (3.9 x 5.8 in.)	X	✓	X	X	✓
Business card 50.8 x 88.9 mm (2 x 3.5 in.)	X	X	X	X	✓
Statement 140 x 216 mm (5.5 x 8.5 in.)	✓	✓	X	✓	✓
Executive 184 x 267 mm (7.3 x 10.5 in.)	✓	✓	X	✓	✓

¹ This paper size is not supported in the optional tray.

² This paper source supports paper size only up to 216 x 297 mm (8.5 x 11.7 in.).

Paper size	Tray	Multipurpose feeder	Two-sided printing	ADF	Scanner glass
Letter 216 x 279 mm (8.5 x 11 in.)	✓	✓	✓	✓	✓
Legal 216 x 356 mm (8.5 x 14 in.)	✓	✓	✓	✓	X
Folio 216 x 330 mm (8.5 x 13 in.)	✓	✓	✓	✓	X
Universal 76.2 x 127 mm to 216 x 356 mm (3 x 5 in. to 8.5 x 14 in.)	✓	✓	X	✓	✓ ²
7 3/4 Envelope (Monarch) 98 x 191 mm (3.9 x 7.5 in.)	X	✓	X	X	✓
9 Envelope 98 x 225 mm (3.9 x 8.9 in.)	X	✓	X	X	✓
10 Envelope 105 x 241 mm (4.1 x 9.5 in.)	X	✓	X	X	✓
DL Envelope 110 x 220 mm (4.3 x 8.7 in.)	X	✓	X	X	✓
C5 Envelope 162 x 229 mm (6.4 x 9 in.)	X	✓	X	X	✓
B5 Envelope 176 x 250 mm (6.9 x 9.8 in.)	X	✓	X	X	✓
Other Envelope 76.2 x 127 mm to 216 x 356 mm (3 x 5 in. to 8.5 x 14 in.)	X	✓	X	X	✓

¹ This paper size is not supported in the optional tray.

² This paper source supports paper size only up to 216 x 297 mm (8.5 x 11.7 in.).

Supported paper types

Paper type	Tray	Multipurpose feeder	Two-sided printing
Plain paper	✓	✓	✓
Card stock	X	✓	X
Transparency	✓	✓	X
Recycled	✓	✓	✓
Paper labels ¹	✓	✓	X
Bond ²	✓	✓	✓
Letterhead	✓	✓	✓
Preprinted	✓	✓	✓
Colored Paper	✓	✓	✓
Light Paper	✓	✓	✓
Heavy Paper ²	✓	✓	✓
Rough/Cotton	✓	✓	✓
Envelope	X	✓	X
Rough envelope	X	✓	X

¹ One-sided paper labels designed for laser printers are supported for occasional use. It is recommended to print 20 or fewer pages of paper labels per month. Vinyl, pharmacy, and two-sided labels are not supported.

² Bond and Heavy Paper are supported in two-sided printing up to 90-g/m² (24-lb) paper weight.

Supported paper weights

	Tray	Multipurpose feeder	Two-sided printing
Paper weight	60–120 g/m ² (16–32 lb)	60–216 g/m ² (16–58 lb)	60–90 g/m ² (16–24 lb)

Printing

Printing from a computer

Note: For labels, card stock, and envelopes, set the paper size and type in the printer before printing the document.

- 1 From the document that you are trying to print, open the Print dialog.
- 2 If necessary, adjust the settings.
- 3 Print the document.

Printing from a mobile device

Printing from a mobile device using Lexmark Mobile Print

Lexmark™ Mobile Print allows you to send documents and images directly to a supported Lexmark printer.

- 1 Open the document, and then send or share the document to Lexmark Mobile Print.



Note: Some third-party applications may not support the send or share feature. For more information, see the documentation that came with the application.

- 2 Select a printer.
- 3 Print the document.

Printing from a mobile device using Mopria Print Service

Mopria® Print Service is a mobile printing solution for mobile devices running on Android™ version 5.0 or later. It allows you to print directly to any Mopria-certified printer.

Note: Make sure that you download the Mopria Print Service application from the Google Play™ store and enable it in the mobile device.

- 1 From your Android mobile device, launch a compatible application or select a document from your file manager.
- 2 Tap  > **Print**.
- 3 Select a printer, and then adjust the settings, if necessary.
- 4 Tap .

Printing from a mobile device using AirPrint

The AirPrint software feature is a mobile printing solution that allows you to print directly from Apple devices to an AirPrint-certified printer.

Notes:



- Make sure that the Apple device and the printer are connected to the same network. If the network has multiple wireless hubs, then make sure that both devices are connected to the same subnet.
- This application is supported only in some Apple devices.

- 1 From your mobile device, select a document from your file manager or launch a compatible application.
- 2 Tap  > **Print**.
- 3 Select a printer, and then adjust the settings, if necessary.
- 4 Print the document.

Printing from a mobile device using Wi-Fi Direct®

Wi-Fi Direct® is a printing service that lets you print to any Wi-Fi Direct-ready printer.

Note: Make sure that the mobile device is connected to the printer wireless network. For more information, see [“Connecting a mobile device to the printer” on page 122](#).

- 1 From your mobile device, launch a compatible application or select a document from your file manager.
- 2 Depending on your mobile device, do one of the following:
 - Tap  > **Print**.
 - Tap  > **Print**.
 - Tap  > **Print**.
- 3 Select a printer, and then adjust the settings, if necessary.
- 4 Print the document.

Printing a font sample list



- 1 From the control panel, navigate to:

 > **Settings** >  > **Reports** >  > **Print** >  > **Print Fonts**

- 2 Select **PCL Fonts** or **PostScript Fonts**, and then press .

Copying

Using the automatic document feeder and scanner glass

Automatic document feeder (ADF)	Scanner glass
 <ul style="list-style-type: none"> • Use the ADF for multiple-page or two-sided documents. • Load an original document faceup. For multiple-page documents, make sure to align the leading edge before loading. • Make sure to adjust the ADF guides to match the width of the paper that you are loading. 	 <ul style="list-style-type: none"> • Use the scanner glass for single-page documents, book pages, small items (such as postcards or photos), transparencies, photo paper, or thin media (such as magazine clippings). • Place the document facedown in the corner with the arrow.

Making copies

- 1 Load an original document into the ADF tray or on the scanner glass.

Note: To avoid a cropped image, make sure that the original document and the output have the same paper size.

- 2 From the control panel, specify the number of copies.
- 3 If necessary, adjust the copy settings.
- 4 Copy the document.

Note: To make a quick copy, from the control panel, press .





Copying photos

- 1 Place a photo on the scanner glass.
- 2 From the control panel, navigate to:



 > Copy >  > Content Type >  > Photo

- 3 From the Content Source menu, select the setting that best matches the original photo.
- 4 Send the copy job.



Copying on letterhead

- 1 Load an original document into the ADF tray or on the scanner glass.
- 2 From the control panel, navigate to:
 > **Copy** >  > **Copy from** > select the size of the original document
- 3 In the Copy to menu, select a paper source.
If you are loading into the multipurpose feeder, then navigate to:
MP Feeder >  > select a paper size > **Letterhead** > 
- 4 Copy the document.



Copying on both sides of the paper

- 1 Load an original document into the ADF tray or on the scanner glass.
- 2 From the control panel, navigate to:
 > **Copy** >  > **Sides**
- 3 Adjust the setting.
- 4 Copy the document.



Reducing or enlarging copies

- 1 Load an original document into the ADF tray or on the scanner glass.
- 2 From the control panel, navigate to:
 > **Copy** >  > **Scale** > specify a scale value
Note: Changing the size of the original document or output after setting Scale restores the scale value to Auto.
- 3 Copy the document.



Collating copies

- 1 Load an original document into the ADF tray or on the scanner glass.
- 2 From the control panel, navigate to:
 > **Copy** >  > **Collate** > **On [1,2,1,2,1,2]**
- 3 Copy the document.

Placing separator sheets between copies

- 1 Load an original document into the ADF tray or on the scanner glass.
- 2 From the control panel, navigate to:
 > **Copy** >  > **Separator Sheets**
- 3 Adjust the settings.
- 4 Copy the document.

Copying multiple pages onto a single sheet

- 1 Load an original document into the ADF tray or on the scanner glass.
- 2 From the control panel, navigate to:
 > **Copy** >  > **Pages Per Side**
- 3 Adjust the settings.
- 4 Copy the document.

Creating a copy shortcut

Note: You may need administrative rights to create a shortcut.

- 1 Open a web browser, and then type the printer IP address in the address field.



Notes:

- View the printer IP address on the home screen. The IP address appears as four sets of numbers separated by periods, such as 123.123.123.123.
- If you are using a proxy server, then temporarily disable it to load the web page correctly.

- 2 Click **Shortcuts** > **Add Shortcut**.
- 3 From the Shortcut Type menu, select **Copy**, and then configure the settings.
- 4 Apply the changes.

E-mailing

Using the automatic document feeder and scanner glass

Automatic document feeder (ADF)	Scanner glass
 <ul style="list-style-type: none"> • Use the ADF for multiple-page or two-sided documents. • Load an original document faceup. For multiple-page documents, make sure to align the leading edge before loading. • Make sure to adjust the ADF guides to match the width of the paper that you are loading. 	 <ul style="list-style-type: none"> • Use the scanner glass for single-page documents, book pages, small items (such as postcards or photos), transparencies, photo paper, or thin media (such as magazine clippings). • Place the document facedown in the corner with the arrow.

Configuring the e-mail SMTP settings

Configure the Simple Mail Transfer Protocol (SMTP) settings to send a scanned document through e-mail. The settings vary with each e-mail service provider.

Before you begin, make sure that the printer is connected to a network and that the network is connected to the Internet.

Using the Embedded Web Server

- 1 Open a web browser, and then type the printer IP address in the address field.

Notes:

- View the printer IP address on the printer home screen. The IP address appears as four sets of numbers separated by periods, such as 123.123.123.123.
- If you are using a proxy server, then temporarily disable it to load the web page correctly.

- 2 Click **Settings** > **E-mail**.

- 3 From the E-mail Setup section, configure the settings.

Notes:

- For more information on the password, see the list of [e-mail service providers](#).

- For e-mail service providers that are not on the list, contact your provider and ask for the settings.

4 Click **Save**.

Using the Settings menu in the printer

1 From the control panel, navigate to:

Settings > **OK** > **E-mail** > **OK** > **E-mail Setup** > **OK**

2 Configure the settings.

Notes:

- For more information on the password, see the list of [e-mail service providers](#).
- For e-mail service providers that are not on the list, contact your provider and ask for the settings.

E-mail service providers

- [AOL Mail](#)
- [Comcast Mail](#)
- [Gmail](#)
- [iCloud Mail](#)
- [Mail.com](#)
- [NetEase Mail \(mail.126.com\)](#)
- [NetEase Mail \(mail.163.com\)](#)
- [NetEase Mail \(mail.yeah.net\)](#)
- [Outlook Live or Microsoft 365](#)
- [QQ Mail](#)
- [Sina Mail](#)
- [Sohu Mail](#)
- [Yahoo! Mail](#)
- [Zoho Mail](#)

Notes:

- If you encounter errors using the settings provided, then contact your e-mail service provider.
- For e-mail service providers that are not on the list, contact your provider.

AOL Mail

Setting	Value
Primary SMTP Gateway	smtp.aol.com
Primary SMTP Gateway Port	587
Use SSL/TLS	Required
Require Trusted Certificate	Disabled
Reply Address	Your e-mail address
SMTP Server Authentication	Login / Plain

Setting	Value
Device-Initiated E-mail	Use Device SMTP Credentials
Device UserID	Your e-mail address
Device Password	App password Note: To create an app password, go to the AOL Account Security page, log in to your account, and then click Generate app password .

Comcast Mail

Setting	Value
Primary SMTP Gateway	smtp.comcast.net
Primary SMTP Gateway Port	587
Use SSL/TLS	Required
Require Trusted Certificate	Disabled
Reply Address	Your e-mail address
SMTP Server Authentication	Login / Plain
Device-Initiated E-mail	Use Device SMTP Credentials
Device UserID	Your e-mail address
Device Password	Account password

Gmail™

Note: Make sure that two-step verification is enabled on your Google account. To enable two-step verification, go to the [Google Account Security](#) page, log in to your account, and then from the “Signing in to Google” section, click **2-Step Verification**.

Setting	Value
Primary SMTP Gateway	smtp.gmail.com
Primary SMTP Gateway Port	587
Use SSL/TLS	Required
Require Trusted Certificate	Disabled
Reply Address	Your e-mail address
SMTP Server Authentication	Login / Plain
Device-Initiated E-mail	Use Device SMTP Credentials
Device UserID	Your e-mail address
Device Password	App password Notes: <ul style="list-style-type: none"> To create an app password, go to the Google Account Security page, log in to your account, and then from the “Signing in to Google” section, click App passwords. “App passwords” shows only if two-step verification is enabled.

iCloud Mail

Note: Make sure that two-step verification is enabled on your account.

Setting	Value
Primary SMTP Gateway	smtp.mail.me.com
Primary SMTP Gateway Port	587
Use SSL/TLS	Required
Require Trusted Certificate	Disabled
Reply Address	Your e-mail address
SMTP Server Authentication	Login / Plain
Device-Initiated E-mail	Use Device SMTP Credentials
Device UserID	Your e-mail address
Device Password	App password Note: To create an app password, go to the iCloud Account Management page, log in to your account, and then from the Security section, click Generate Password .

Mail.com

Setting	Value
Primary SMTP Gateway	smtp.mail.com
Primary SMTP Gateway Port	587
Use SSL/TLS	Required
Require Trusted Certificate	Disabled
Reply Address	Your e-mail address
SMTP Server Authentication	Login / Plain
Device-Initiated E-mail	Use Device SMTP Credentials
Device UserID	Your e-mail address
Device Password	Account password

NetEase Mail (mail.126.com)

Note: Make sure that the SMTP service is enabled on your account. To enable the service, from the NetEase Mail home page, click **Settings > POP3/SMTP/IMAP**, and then enable either **IMAP/SMTP service** or **POP3/SMTP service**.

Setting	Value
Primary SMTP Gateway	smtp.126.com
Primary SMTP Gateway Port	465
Use SSL/TLS	Required
Require Trusted Certificate	Disabled

Setting	Value
Reply Address	Your e-mail address
SMTP Server Authentication	Login / Plain
Device-Initiated E-mail	Use Device SMTP Credentials
Device UserID	Your e-mail address
Device Password	Authorization password Note: The authorization password is provided when IMAP/SMTP service or POP3/SMTP service is enabled.

NetEase Mail (mail.163.com)

Note: Make sure that the SMTP service is enabled on your account. To enable the service, from the NetEase Mail home page, click **Settings** > **POP3/SMTP/IMAP**, and then enable either **IMAP/SMTP service** or **POP3/SMTP service**.

Setting	Value
Primary SMTP Gateway	smtp.163.com
Primary SMTP Gateway Port	465
Use SSL/TLS	Required
Require Trusted Certificate	Disabled
Reply Address	Your e-mail address
SMTP Server Authentication	Login / Plain
Device-Initiated E-mail	Use Device SMTP Credentials
Device UserID	Your e-mail address
Device Password	Authorization password Note: The authorization password is provided when IMAP/SMTP service or POP3/SMTP service is enabled.

NetEase Mail (mail.yeah.net)

Note: Make sure that the SMTP service is enabled on your account. To enable the service, from the NetEase Mail home page, click **Settings** > **POP3/SMTP/IMAP**, and then enable either **IMAP/SMTP service** or **POP3/SMTP service**.

Setting	Value
Primary SMTP Gateway	smtp.yeah.net
Primary SMTP Gateway Port	465
Use SSL/TLS	Required
Require Trusted Certificate	Disabled
Reply Address	Your e-mail address
SMTP Server Authentication	Login / Plain

Setting	Value
Device-Initiated E-mail	Use Device SMTP Credentials
Device UserID	Your e-mail address
Device Password	Authorization password Note: The authorization password is provided when IMAP/SMTP service or POP3/SMTP service is enabled.

Outlook Live or Microsoft 365

These settings apply to outlook.com and hotmail.com e-mail domains, and Microsoft 365 accounts.

Setting	Value
Primary SMTP Gateway	smtp.office365.com
Primary SMTP Gateway Port	587
Use SSL/TLS	Required
Require Trusted Certificate	Disabled
Reply Address	Your e-mail address
SMTP Server Authentication	Login / Plain
Device-Initiated E-mail	Use Device SMTP Credentials
Device UserID	Your e-mail address
Device Password	Account password or app password Notes: <ul style="list-style-type: none"> • For accounts with two-step verification disabled, use your account password. • For outlook.com or hotmail.com accounts with two-step verification enabled, use an app password. To create an app password, go to the Outlook Live Account Management page, and then log in to your account.

Note: For additional setup options for business using Microsoft 365, go to the [Microsoft 365 help page](#).

QQ Mail

Note: Make sure that the SMTP service is enabled on your account. To enable the service, from the QQ Mail home page, click **Settings** > **Account**. From the POP3/IMAP/SMTP/Exchange/CardDAV/CalDAV Service section, enable either **POP3/SMTP service** or **IMAP/SMTP service**.

Setting	Value
Primary SMTP Gateway	smtp.qq.com
Primary SMTP Gateway Port	587
Use SSL/TLS	Required
Require Trusted Certificate	Disabled
Reply Address	Your e-mail address

Setting	Value
SMTP Server Authentication	Login / Plain
Device-Initiated E-mail	Use Device SMTP Credentials
Device UserID	Your e-mail address
Device Password	Authorization code Note: To generate an authorization code, from the QQ Mail home page, click Settings > Account , and then from the POP3/IMAP/SMTP/Exchange/CardDAV/CalDAV Service section, click Generate authorization code .

Sina Mail

Note: Make sure that the POP3/SMTP service is enabled on your account. To enable the service, from the Sina Mail home page, click **Settings > More settings > User-end POP/IMAP/SMTP**, and then enable **POP3/SMTP service**.

Setting	Value
Primary SMTP Gateway	smtp.sina.com
Primary SMTP Gateway Port	587
Use SSL/TLS	Required
Require Trusted Certificate	Disabled
Reply Address	Your e-mail address
SMTP Server Authentication	Login / Plain
Device-Initiated E-mail	Use Device SMTP Credentials
Device UserID	Your e-mail address
Device Password	Authorization code Note: To create an authorization code, from the e-mail home page, click Settings > More settings > User-end POP/IMAP/SMTP , and then enable Authorization code status .

Sohu Mail

Note: Make sure that the SMTP service is enabled on your account. To enable the service, from the Sohu Mail home page, click **Options > Settings > POP3/SMTP/IMAP**, and then enable either **IMAP/SMTP service** or **POP3/SMTP service**.

Setting	Value
Primary SMTP Gateway	smtp.sohu.com
Primary SMTP Gateway Port	465
Use SSL/TLS	Required
Require Trusted Certificate	Disabled
Reply Address	Your e-mail address
SMTP Server Authentication	Login / Plain

Setting	Value
Device-Initiated E-mail	Use Device SMTP Credentials
Device UserID	Your e-mail address
Device Password	Independent password Note: The independent password is provided when IMAP/SMTP service or POP3/SMTP service is enabled.

Yahoo! Mail

Setting	Value
Primary SMTP Gateway	smtp.mail.yahoo.com
Primary SMTP Gateway Port	587
Use SSL/TLS	Required
Require Trusted Certificate	Disabled
Reply Address	Your e-mail address
SMTP Server Authentication	Login / Plain
Device-Initiated E-mail	Use Device SMTP Credentials
Device UserID	Your e-mail address
Device Password	App password Note: To create an app password, go to the Yahoo Account Security page, log in to your account, and then click Generate app password .

Zoho Mail

Setting	Value
Primary SMTP Gateway	smtp.zoho.com
Primary SMTP Gateway Port	587
Use SSL/TLS	Required
Require Trusted Certificate	Disabled
Reply Address	Your e-mail address
SMTP Server Authentication	Login / Plain
Device-Initiated E-mail	Use Device SMTP Credentials
Device UserID	Your e-mail address

Setting	Value
Device Password	Account password or app password Notes: <ul style="list-style-type: none">• For accounts with two-step verification disabled, use your account password.• For accounts with two-step verification enabled, use an app password. To create an app password, go to the Zoho Mail Account Security page, log in to your account, and then from the Application-Specific Passwords section, click Generate New Password.

Creating an e-mail shortcut

Note: You may need administrative rights to create a shortcut.

- 1 Open a web browser, and then type the printer IP address in the address field.

Notes:

- View the printer IP address on the home screen. The IP address appears as four sets of numbers separated by periods, such as 123.123.123.123.
- If you are using a proxy server, then temporarily disable it to load the web page correctly.

- 2 Click **Shortcuts > Add Shortcut**.

- 3 From the Shortcut Type menu, select **E-mail**, and then configure the settings.

- 4 Apply the changes.

Sending an e-mail using a shortcut number

- 1 Load the original document into the ADF tray or on the scanner glass.
- 2 From the control panel, press **#**, and then enter the shortcut number using the keypad.
- 3 Send the e-mail.

Faxing

Setting up the printer to fax

Notes:

- The following connection methods are applicable only in some countries or regions.
- During the initial printer setup, clear the fax function check box and any other function you plan to set up later, and then select **Continue**.
- If the fax function is enabled and not fully set up, then the indicator light may blink red.

Warning—Potential Damage: To avoid loss of data or printer malfunction, do not touch cables or the printer in the area shown while actively sending or receiving a fax.



Supported fax

Printer model	Analog fax	etherFAX ¹	Fax server	Fax over IP (FoIP) ²
MB2338adw	✓	✓	✗	✓
MX321adn	✓	✓	✗	✓
MX321adw	✓	✓	✗	✓

¹ Needs a subscription. For more information, go to <https://www.etherfax.net/lexmark> or contact the place where you purchased the printer.

² Needs an installed license bundle. For more information, contact the place where you purchased the printer.

Setting up the fax function using analog fax

Notes:

- Some connection methods are applicable only in some countries or regions.
- If the fax function is enabled and not fully set up, then the indicator light may blink red.
- If you do not have a TCP/IP environment, then use the control panel to set up fax.

Warning—Potential Damage: To avoid loss of data or printer malfunction, do not touch cables or the printer in the area shown while actively sending or receiving a fax.



Using the Settings menu in the printer

1 From the control panel, navigate to:

Settings > **OK** > **Fax** > **OK** > **Fax Setup** > **OK** > **General Fax settings** > **OK**

2 Configure the settings.

Using the Embedded Web Server

1 Open a web browser, and then type the printer IP address in the address field.

Notes:

- View the printer IP address on the home screen. The IP address appears as four sets of numbers separated by periods, such as 123.123.123.123.
- If you are using a proxy server, then temporarily disable it to load the web page correctly.

2 Click **Settings** > **Fax** > **Fax Setup** > **General Fax Settings**.

- 3 Configure the settings.
- 4 Apply the changes.

Setting up the fax function using etherFAX

Notes:

- The printer firmware must be updated to the latest version. For more information, see the “Updating firmware” section.
- An appropriate license bundle must be installed in your printer. For more information, contact etherFAX.
- Make sure that you have registered your printer to the etherFAX portal. For more information, go to <https://www.etherfax.net/lexmark>.
- The printer serial number is required on registration. To locate the serial number, see [“Finding the printer serial number” on page 11](#).

- 1 Open a web browser, and then type the printer IP address in the address field.

Notes:

- View the printer IP address on the home screen. The IP address appears as four sets of numbers separated by periods, such as 123.123.123.123.
- If you are using a proxy server, then temporarily disable it to load the web page correctly.

- 2 Click **Settings > Fax > Fax Setup > General Fax Settings**.

Note: Fax Setup appears only if Fax Mode is set to Fax.



- 3 In the Fax Name field, type a unique name.
- 4 In the Fax Number field, enter the fax number that etherFAX provided.
- 5 From the Fax Transport menu, select **etherFAX**.

Notes:

- This menu shows up only when more than one fax transport is available.
- If the printer only has etherFAX installed, then it is automatically configured.

- 6 Apply the changes.

Setting up fax using a standard telephone line

-  **CAUTION—SHOCK HAZARD:** To avoid the risk of electrical shock, do not set up this product or make any electrical or cabling connections, such as the power cord, fax feature, or telephone, during a lightning storm.
-  **CAUTION—SHOCK HAZARD:** To avoid the risk of electrical shock, do not use the fax feature during a lightning storm.
-  **CAUTION—POTENTIAL INJURY:** To reduce the risk of fire, use only a 26 AWG or larger telecommunications (RJ-11) cord when connecting this product to the public switched telephone network. For users in Australia, the cord must be approved by the Australian Communications and Media Authority.

Setup 1: Printer is connected to a dedicated fax line

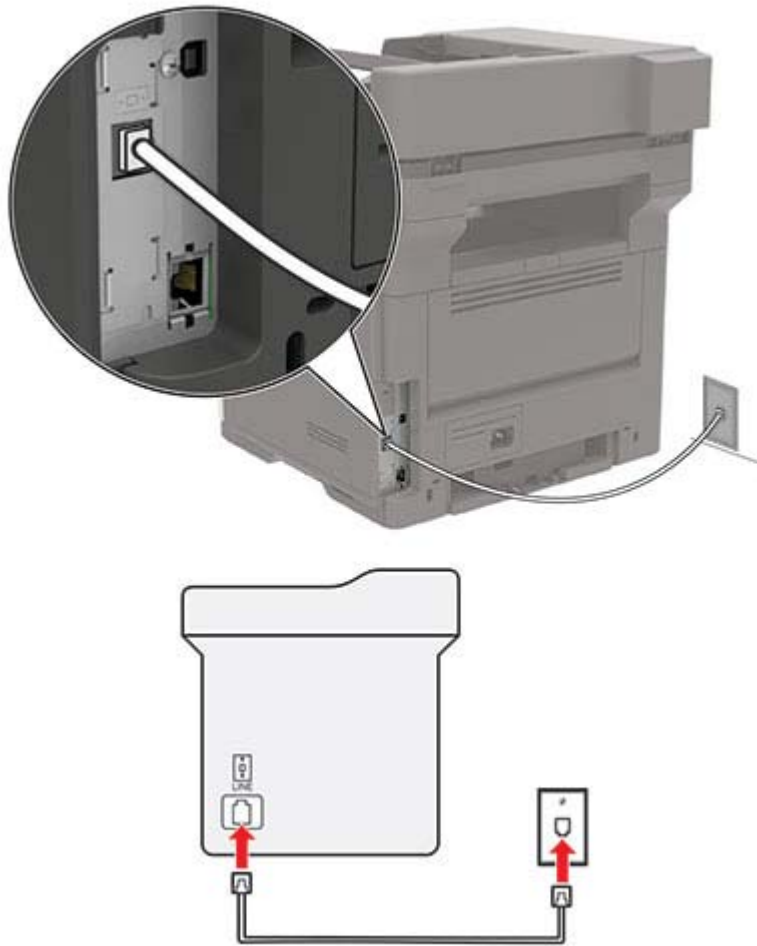

- 1 Connect one end of the telephone cable to the line port of the printer.
- 2 Connect the other end of the cable to an active analog wall jack.

Notes:

- You can set the printer to receive faxes automatically (Auto Answer On) or manually (Auto Answer Off).
- If you want to receive faxes automatically, then set the printer to pick up on a specified number of rings.

Setup 2: Printer is sharing the line with an answering machine

Note: If you subscribe to a distinctive ring service, then make sure that you set the correct ring pattern for the printer. Otherwise, the printer does not receive faxes even if you have set it to receive faxes automatically.

Connected to different wall jacks

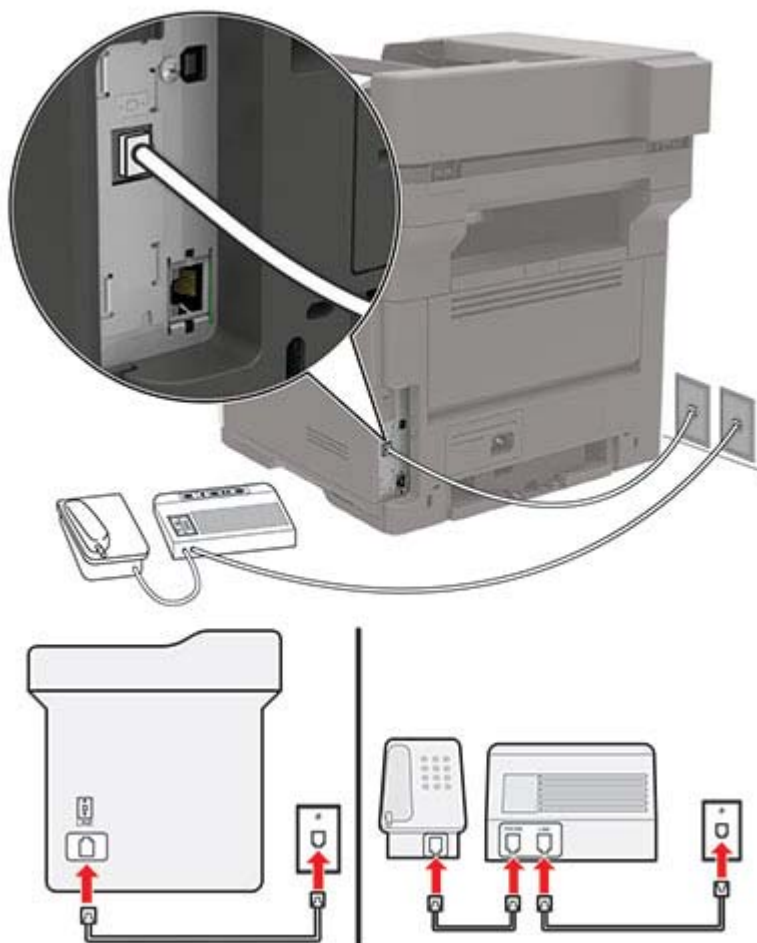

- 1 Connect one end of the telephone cable to the line port of the printer.
- 2 Connect the other end of the cable to an active analog wall jack.

Notes:

- If you have only one telephone number on your line, then set the printer to receive faxes automatically.
- Set the printer to pick up calls two rings after the answering machine. For example, if the answering machine picks up calls after four rings, then set the printer Rings to Answer setting to six.

Setting up fax in countries or regions with different telephone wall jacks and plugs

⚡ CAUTION—SHOCK HAZARD: To avoid the risk of electrical shock, do not set up this product or make any electrical or cabling connections, such as the power cord, fax feature, or telephone, during a lightning storm.

⚡ CAUTION—SHOCK HAZARD: To avoid the risk of electrical shock, do not use the fax feature during a lightning storm.

⚠ CAUTION—POTENTIAL INJURY: To reduce the risk of fire, use only a 26 AWG or larger telecommunications (RJ-11) cord when connecting this product to the public switched telephone network. For users in Australia, the cord must be approved by the Australian Communications and Media Authority.

The standard wall jack adopted by most countries or regions is RJ11. If the wall jack or equipment in your facility is not compatible with this type of connection, then use a telephone adapter. An adapter for your country or region may not come with your printer, and you may need to purchase it separately.

There may be an adapter plug installed in the telephone port of the printer. Do not remove the adapter plug from the telephone port of the printer if you are connecting to a serial or cascaded telephone system.

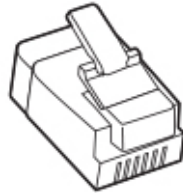

Part name	Part number
Lexmark adapter plug	40X8519

Connecting the printer to a non-RJ11 wall jack

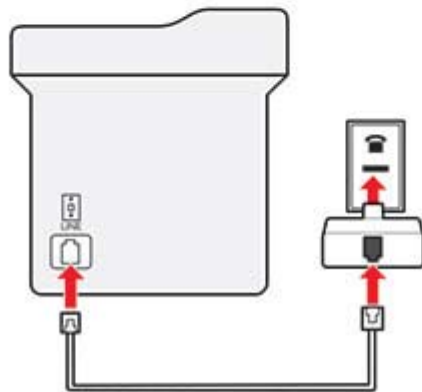
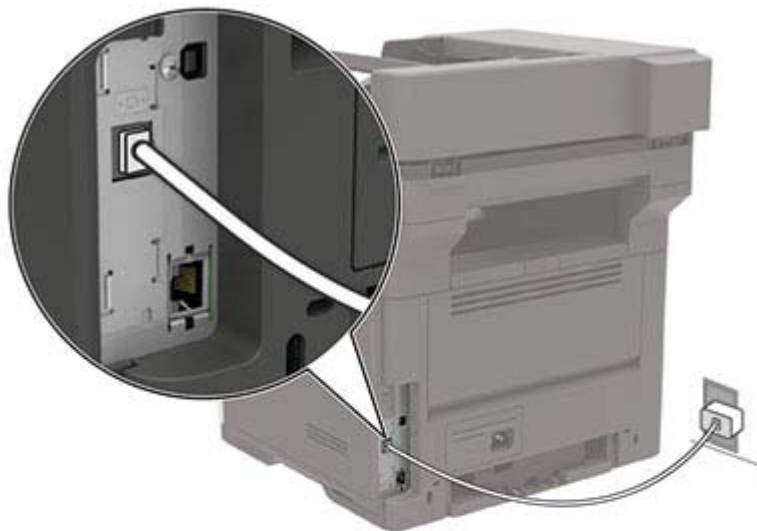

- 1 Connect one end of the telephone cable to the line port of the printer.
- 2 Connect the other end of the cable to the RJ11 adapter, and then connect the adapter to the wall jack.
- 3 If you want to connect another device with a non-RJ11 connector to the same wall jack, then connect it directly to the telephone adapter.

Connecting to a distinctive ring service

A distinctive ring service lets you have multiple telephone numbers on one telephone line. Each telephone number is assigned a different ring pattern.

- 1 From the control panel, navigate to:

Settings > **OK** > **Fax** > **OK** > **Fax Setup** > **OK** > **Fax Receive Settings** > **OK** > **Admin Controls** > **OK** >
Answer On > **OK**

- 2 Select a ring pattern.

Setting the fax date and time

Note: Make sure that fax is configured. For more information, see [“Setting up the printer to fax” on page 38](#).

1 From the control panel, navigate to:

Settings > **OK** > Device > **OK** > Preferences > **OK** > Date and Time > **OK** > Configure > **OK**

2 Configure the settings.

Configuring daylight saving time

Note: Make sure that fax is configured. For more information, see [“Setting up the printer to fax” on page 38](#).



1 From the control panel, navigate to:

Settings > **OK** > Device > **OK** > Preferences > **OK** > Date and Time > **OK** > Configure > **OK**

2 In the Time Zone menu, select **(UTC+user) Custom**.

3 Configure the settings.

Using the automatic document feeder and scanner glass

Automatic document feeder (ADF)	Scanner glass
 <ul style="list-style-type: none"> • Use the ADF for multiple-page or two-sided documents. • Load an original document faceup. For multiple-page documents, make sure to align the leading edge before loading. • Make sure to adjust the ADF guides to match the width of the paper that you are loading. 	 <ul style="list-style-type: none"> • Use the scanner glass for single-page documents, book pages, small items (such as postcards or photos), transparencies, photo paper, or thin media (such as magazine clippings). • Place the document facedown in the corner with the arrow.



Sending a fax

Note: Make sure that fax is configured. For more information, see [“Setting up the printer to fax” on page 38](#).

Using the control panel

1 Load an original document into the ADF tray or on the scanner glass.

2 From the control panel, navigate to:

 > **Fax** >  > enter the needed information > 

If necessary, adjust the settings.

3 Send the fax.

Using the computer

Before you begin, make sure that the fax driver is installed. For more information, see [“Installing the fax driver” on page 210](#).

For Windows users

1 From the document that you are trying to fax, open the Print dialog.

2 Select the printer, and then click **Properties, Preferences, Options,** or **Setup**.

3 Click **Fax > Enable fax > Always display settings prior to faxing**, and then enter the recipient number.
If necessary, configure other fax settings.

4 Send the fax.

For Macintosh users

1 With a document open, choose **File > Print**.

2 Select the printer that has - **Fax** added after its name.

3 In the To field, enter the recipient number.
If necessary, configure other fax settings.



4 Send the fax.

Scheduling a fax

Note: Make sure that fax is configured. For more information, see [“Setting up the printer to fax” on page 38](#).

1 Load an original document into the ADF tray or on the scanner glass.

2 From the control panel, navigate to:

 > **Fax** >  > enter the fax number > **Send Time** > 

3 Configure the date and time, and then press .

4 Send the fax.

Creating a fax destination shortcut

Note: Make sure that fax is configured. For more information, see [“Setting up the printer to fax” on page 38](#).

- 1 Open a web browser, and then type the printer IP address in the address field.

Notes:



- View the printer IP address on the home screen. The IP address appears as four sets of numbers separated by periods, such as 123.123.123.123.
- If you are using a proxy server, then temporarily disable it to load the web page correctly.

- 2 Click **Shortcuts** > **Add Shortcut**.
- 3 From the Shortcut Type menu, select **Fax**, and then configure the settings.
- 4 Apply the changes.

Changing the fax resolution

Note: Make sure that fax is configured. For more information, see [“Setting up the printer to fax” on page 38](#).

- 1 Load an original document into the ADF tray or on the scanner glass.
- 2 From the control panel, navigate to:



 > **Fax** >  > enter the needed information

- 3 Adjust the **Resolution** setting.
- 4 Send the fax.

Adjusting the fax darkness

Note: Make sure that fax is configured. For more information, see [“Setting up the printer to fax” on page 38](#).

- 1 Load an original document into the ADF tray or on the scanner glass.
- 2 From the control panel, navigate to:

 > **Fax** >  > enter the needed information

- 3 Adjust the **Darkness** setting.
- 4 Send the fax.

Printing a fax log

Note: Make sure that fax is configured. For more information, see [“Setting up the printer to fax” on page 38](#).

- 1 From the control panel, navigate to:

Settings >  > **Reports** >  > **Fax** > 

- 2 Select **Fax Job Log** or **Fax Call Log**, and then press .

Blocking junk faxes

Note: Make sure that fax is configured. For more information, see [“Setting up the printer to fax” on page 38](#).

1 From the control panel, navigate to:

Settings > **OK** > **Fax** > **OK** > **Fax Defaults** > **OK** > **Fax Setup** > **OK** > **Fax Receive Settings** > **OK** > **Admin Controls** > **OK**

2 Set **Block No Name Fax** to **On**, and then press **OK**.

Holding faxes

Note: Make sure that fax is configured. For more information, see [“Setting up the printer to fax” on page 38](#).

1 Open a web browser, and then type the printer IP address in the address field.

Notes:

- View the printer IP address on the printer home screen. The IP address appears as four sets of numbers separated by periods, such as 123.123.123.123.
- If you are using a proxy server, then temporarily disable it to load the web page correctly.

2 Click **Settings** > **Fax** > **Fax Setup** > **Fax Receive Settings** > **Holding Faxes**.

3 Select a mode.

4 Click **Save**.

Forwarding a fax

Note: Make sure that fax is configured. For more information, see [“Setting up the printer to fax” on page 38](#).

1 Create a destination shortcut.

a Open a web browser, and then type the printer IP address in the address field.

Notes:

- View the printer IP address on the home screen. The IP address appears as four sets of numbers separated by periods, such as 123.123.123.123.
- If you are using a proxy server, then temporarily disable it to load the web page correctly.

b Click **Shortcuts** > **Add Shortcut**.

c Select a shortcut type, and then configure the settings.

Note: Take note of the shortcut number.

d Apply the changes.



2 Click **Settings** > **Fax** > **Fax Setup** > **Fax Receive Settings** > **Admin Controls**.

3 In the Fax Forwarding menu, select **Forward** or **Print and Forward**.

- 4** In the Forward to menu, select the destination type and then type the shortcut number.
- 5** Apply the changes.

Scanning

Using the automatic document feeder and scanner glass

Automatic document feeder (ADF)	Scanner glass
 <ul style="list-style-type: none"> • Use the ADF for multiple-page or two-sided documents. • Load an original document faceup. For multiple-page documents, make sure to align the leading edge before loading. • Make sure to adjust the ADF guides to match the width of the paper that you are loading. 	 <ul style="list-style-type: none"> • Use the scanner glass for single-page documents, book pages, small items (such as postcards or photos), transparencies, photo paper, or thin media (such as magazine clippings). • Place the document facedown in the corner with the arrow.

Scanning to a computer

Before you begin, make sure that:

- The printer firmware is updated. For more information, see the “Updating firmware” section.
- The computer and the printer are connected to the same network.

For Windows users

Using Lexmark ScanBack Utility

- 1 From the computer, run Lexmark ScanBack Utility, and then click **Next**.

Note: To download the utility, go to www.lexmark.com/downloads.

- 2 Click **Setup**, and then add the printer IP address.

Note: View the printer IP address on the printer home screen. The IP address appears as four sets of numbers separated by periods, such as 123.123.123.123.

- 3 Click **Close > Next**.

- 4 Select the size of the original document, and then click **Next**.

- 5 Select a file format and scan resolution, and then click **Next**.

- 6 Type a unique scan profile name, and then click **Next**.

- 7 Browse to the location you want to save the scanned document, create a file name, and then click **Next**.
Note: To reuse the scan profile, enable **Create Shortcut**, and then create a unique shortcut name.
- 8 Click **Finish**.
- 9 Load an original document into the automatic document feeder or on the scanner glass.
- 10 From the printer control panel, select **Scan to Computer**, and then select a scan profile.
Note: Make sure that Scan to Computer is enabled. From the control panel, navigate to **Settings > Device > Visible Home Screen Icons > Scan to Computer > Display**.

Using Windows Fax and Scan

Note: Make sure that the printer is added to the computer. For more information, see [“Adding printers to a computer” on page 210](#).

- 1 Load an original document into the automatic document feeder or on the scanner glass.
- 2 From the computer, open **Windows Fax and Scan**.
- 3 From the Source menu, select a scanner source.
- 4 If necessary, change the scan settings.
- 5 Scan the document.

For Macintosh users

Note: Make sure that the printer is added to the computer. For more information, see [“Adding printers to a computer” on page 210](#).

- 1 Load an original document into the automatic document feeder or on the scanner glass.
- 2 From the computer, do either of the following:
 - Open **Image Capture**.
 - Open **Printers & Scanners**, and then select a printer. Click **Scan > Open Scanner**.
- 3 From the Scanner window, do one or more of the following:
 - Select where you want to save the scanned document.
 - Select the size of the original document.
 - To scan from the ADF, select **Document Feeder** from the Scan Menu or enable **Use Document Feeder**.
 - If necessary, configure the scan settings.
- 4 Click **Scan**.

Creating an FTP shortcut

Note: You may need administrative rights to create a shortcut.

- 1 Open a web browser, and then type the printer IP address in the address field.

Notes:

- View the printer IP address on the printer home screen. The IP address appears as four sets of numbers separated by periods, such as 123.123.123.123.

- If you are using a proxy server, then temporarily disable it to load the web page correctly.

2 Click **Shortcuts > Add Shortcut**.

3 From the Shortcut Type menu, select **FTP**, and then configure the settings.

4 Apply the changes.

Creating a network folder shortcut

1 Open a web browser, and then type the printer IP address in the address field.

Notes:

- View the printer IP address on the printer home screen. The IP address appears as four sets of numbers separated by periods, such as 123.123.123.123.
- If you are using a proxy server, then temporarily disable it to load the web page correctly.

2 Click **Shortcuts > Add Shortcut**.

3 From the Shortcut Type menu, select **Network Folder**, and then configure the settings.

4 Apply the changes.

Scanning to an FTP server using a shortcut number

1 Load the original document into the ADF tray or on the scanner glass.

2 From the control panel, press **#**, and then enter the shortcut number using the keypad.

3 Scan the document.

Understanding the printer menus

Menu map

Device	<ul style="list-style-type: none"> • Preferences • Eco-Mode • Remote Operator Panel • Notifications • Power Management 	<ul style="list-style-type: none"> • Anonymous Data Collection • Restore Factory Defaults • Maintenance • Visible Home Screen Icons • About this Printer
Print	<ul style="list-style-type: none"> • Layout • Setup • Quality • Job Accounting • XPS 	<ul style="list-style-type: none"> • PDF • PostScript • PCL • HTML • Image
Paper	<ul style="list-style-type: none"> • Tray Configuration 	<ul style="list-style-type: none"> • Media Configuration
Copy	Copy Defaults	
Fax	Fax Defaults	
E-mail	<ul style="list-style-type: none"> • E-mail Setup • E-mail Defaults 	<ul style="list-style-type: none"> • Web Link Setup
FTP	FTP Defaults	
Network/Ports	<ul style="list-style-type: none"> • Network Overview • Wireless • Wi-Fi Direct • Ethernet • TCP/IP • SNMP 	<ul style="list-style-type: none"> • IPSec • 802.1x • LPD Configuration • HTTP/FTP Settings • ThinPrint • USB
Security	<ul style="list-style-type: none"> • Security Audit Log • Login Restrictions • Confidential Print Setup 	<ul style="list-style-type: none"> • Solutions LDAP Settings • Mobile Services Management • Miscellaneous
Reports	<ul style="list-style-type: none"> • Menu Settings Page • Device • Print 	<ul style="list-style-type: none"> • Shortcuts • Fax • Network
Help	<ul style="list-style-type: none"> • Print All Guides • Connection Guide • Copy Guide • E-mail Guide • Fax Guide • FTP Guide 	<ul style="list-style-type: none"> • Information Guide • Media Guide • Mono Quality Guide • Moving Guide • Print Quality Guide • Supplies Guide
Troubleshooting	<ul style="list-style-type: none"> • Print Quality Test Pages 	<ul style="list-style-type: none"> • Cleaning the Scanner

Device

Preferences

Menu item	Description
Display Language [List of languages]	Set the language of the text that appears on the display. Note: Not all languages are available for all printer models. You may need to install special hardware for some languages.
Country/Region [List of countries]	Identify the country that the printer is configured to operate.
Run Initial Setup No Yes*	Run the setup wizard.
Displayed information Display Text 1 Display Text 2 Custom Text 1 Custom Text 2	Specify the information to show on the home screen. Note: Custom Text 1 and Custom Text 2 appear only in some printer models.
Date and Time Configure Manually Set Date and Time Date Format Time Format Time Zone Network Time Protocol Enable NTP NTP Server Enable Authentication Key ID Password	Configure the printer date and time. Notes: <ul style="list-style-type: none"> • Enable Authentication appears only in some printer models. • When Enable Authentication is set to MD5 key, Key ID and Password appear.
Paper Sizes U.S.* Metric	Specify the unit of measurement for paper sizes. Note: The country or region selected in the initial setup wizard determines the initial paper size setting.
Allow Background Removal On* Off	Allow image background removal in copy, fax, e-mail, FTP, or scan-to-USB jobs.
One Page Flatbed Scanning On Off*	Set copies from the scanner glass to only one page at a time.
Note: An asterisk (*) next to a value indicates the factory default setting.	

Menu item	Description
Screen Timeout 10–300 (60*)	Set the idle time in seconds before the display shows the home screen, or before the printer logs off a user account automatically.
Note: An asterisk (*) next to a value indicates the factory default setting.	

Eco-Mode

Menu item	Description
Print Sides 1-Sided* 2-Sided	Specify whether to print on one side or two sides of the paper.
Print Pages per Side Off* 2 pages per side 3 pages per side 4 pages per side 6 pages per side 9 pages per side 12 pages per side 16 pages per side	Print multiple page images on one side of a sheet of paper.
Print Toner Darkness 1–10 (8*)	Determine the lightness or darkness of text images.
Copy Sides 1 sided to 1 sided* 1 sided to 2 sided 2 sided to 1 sided 2 sided to 2 sided	Specify the scanning behavior based on the original document.
Copy Pages per Side Off* 2 Portrait pages 4 Portrait pages 2 Landscape pages 4 Landscape pages	Specify the scanning behavior based on the original document.
Copy Darkness 1–9 (5*)	Determine the darkness of the scanned text images.
Note: An asterisk (*) next to a value indicates the factory default setting.	

Remote Operator Panel

Menu item	Description
External VNC Connection Don't Allow* Allow	Connect an external Virtual Network Computing (VNC) client to the remote control panel.
Authentication Type None* Standard Authentication	Set the authentication type when accessing the VNC client server.
VNC Password	Specify the password to connect to the VNC client server. Note: This menu item appears only if Authentication Type is set to Standard Authentication.
Note: An asterisk (*) next to a value indicates the factory default setting.	

Notifications

Menu item	Description
ADF Loaded Beep Off On*	Enable a sound when loading paper into the ADF.
Alarm Control Off Single* Continuous	Set the number of times that the alarm sounds when the printer requires user intervention.
Supplies Show Supply Estimates Show estimates* Do not show estimates	Show the estimated status of the supplies.
Supplies Display Estimates Pages* Percent	Determine the unit that the printer uses to estimate supply usage and trigger custom notifications when user intervention is required. Note: This menu item appears only in the Embedded Web Server.
Supplies Cartridge Alarm Off* Single Continuous	Set the number of times that the alarm sounds when the toner cartridge is low.
Supplies Custom Supply Notifications	Configure notification settings when the printer requires user intervention. Note: This menu item appears only in the Embedded Web Server.
Note: An asterisk (*) next to a value indicates the factory default setting.	

Menu item	Description
Error Prevention Jam Assist Off On*	Set the printer to flush automatically blank pages or pages with partial prints to the standard bin after a jammed page is cleared.
Error Prevention Auto Continue Disabled 5–255 (5*)	Let the printer continue processing or printing a job automatically after clearing certain attendance conditions.
Error Prevention Auto Reboot Auto Reboot Reboot when idle Reboot always* Reboot never	Set the printer to restart when an error occurs.
Error Prevention Auto Reboot Max Auto Reboots 1–20 (2*)	Set the number of automatic reboots that the printer can perform.
Error Prevention Auto Reboot Auto Reboot Window 1–525600 (720*)	Set the number of seconds before the printer performs an automatic reboot.
Error Prevention Auto Reboot Auto Reboot Counter	Show a read-only information of the reboot counter.
Error Prevention Display Short Paper Error On Auto-clear*	Set the printer to show a message when a short paper error occurs. Note: Short paper refers to the size of the paper loaded.
Error Prevention Page Protect Off* On	Set the printer to process the entire page into the memory before printing it.
Jam Content Recovery Jam Recovery Off On Auto*	Set the printer to reprint jammed pages.
Note: An asterisk (*) next to a value indicates the factory default setting.	

Menu item	Description
Jam Content Recovery Scanner Jam Recovery Job level Page level*	Specify how to restart a scan job after resolving a paper jam.
Note: An asterisk (*) next to a value indicates the factory default setting.	

Power Management

Menu item	Description
Sleep Mode Profile Print with Display off Allow printing with display off* Display on when printing	Allow printing with the display turned off.
Timeouts Sleep Mode 1–120 minutes (15*)	Set the idle time before the printer begins operating in Sleep mode.
Timeouts Hibernate Timeout Disabled 1 hour 2 hours 3 hours 6 hours 1 day 2 days 3 days* 1 week 2 weeks 1 month	Set the time before the printer enters Hibernate mode.
Timeouts Hibernate Timeout on Connection Hibernate Do Not Hibernate*	Set the printer to Hibernate mode even when an active Ethernet connection exists.
Eco-Mode Off* Energy Energy/Paper Paper	Minimize the use of energy, paper, or specialty media. Note: Setting Eco-Mode to Energy or Paper may affect printer performance, but not print quality.
Note: An asterisk (*) next to a value indicates the factory default setting.	

Anonymous Data Collection

Menu item	Description
Anonymous Data Collection Device Usage and Performance Information None*	Send printer usage and performance information to Lexmark. Note: Anonymous Data Send Time appears only when you set Anonymous Data Collection to Device Usage and Performance.
Anonymous Data Send Time Start Time Stop Time	
Note: An asterisk (*) next to a value indicates the factory default setting.	

Restore Factory Defaults

Menu item	Description
Restore Settings Restore all settings Restore printer settings Restore network settings Restore fax settings	Restore the printer factory default settings.

Maintenance

Config Menu

Menu item	Description
USB Configuration USB PnP 1* 2	Change the USB driver mode of the printer to improve its compatibility with a personal computer.
USB Configuration USB Scan to Local On* Off	Enable scanning to a computer.
USB Configuration USB Speed Full Auto*	Set the USB port to run at full speed and disable its high-speed capabilities.
Tray Configuration Tray Linking Automatic* Off	Set the printer to link the trays that have the same paper type and paper size settings.
Note: An asterisk (*) next to a value indicates the factory default setting.	

Menu item	Description
Tray Configuration Show Tray Insert Message Off Only for unknown sizes* Always	Show the Tray Insert message.
Tray Configuration A5 Loading Short Edge* Long Edge	Specify the page orientation when loading A5 paper size.
Tray Configuration Paper Prompts Auto* MP Feeder Manual Paper Envelope Prompts Auto* MP Feeder Manual Envelope	Set the paper source that the user fills when a prompt to load paper or envelope appears. Note: For Multipurpose Feeder to appear, set Configure MP to Cassette from the Paper menu.
Tray Configuration Action for Prompts Prompt user* Continue Use current	Set the printer to resolve paper- or envelope-related change prompts.
Reports Menu Settings Page Event Log Event Log Summary Health Check Statistics	Print reports about printer menu settings, status, and event logs.
Supply Usage And Counters Clear Supply Usage History Reset Black Cartridge Counter Reset Black Imaging Unit Counter Reset Maintenance Counter	Reset the supply page counter or view the total printed pages.
Printer Emulations PPDS Emulation Off* On	Set the printer to use the PPDS data stream.
Fax Configuration Fax Low Power Support Disable Sleep Permit Sleep Auto*	Specify the printer power setting when it is in fax mode.
Note: An asterisk (*) next to a value indicates the factory default setting.	

Menu item	Description
Print Configuration Font Sharpening 0–150(24*)	Set a text point-size value below which the high-frequency screens are used when printing font data.
Print Configuration Print Density 1–5 (3*) Copy Density 1–5 (3*)	Adjust the toner density when printing or copying documents.
Device Operations Quiet Mode On Off*	Set the printer to reduce the amount of noise that it makes when printing. Note: This setting slows down the overall performance of the printer.
Device Operations Panel Menus Enable* Disable	Set the printer to show the control panel menus.
Device Operations Safe Mode Off* On	Set the printer to operate in a special mode, in which it attempts to continue offering as much functionality as possible, despite known issues.
Device Operations Minimum Copy Memory 20MB* 30MB 50MB 80MB 100MB	Set the memory allocation for storing copy jobs. Note: The values appear only if the amount of installed DRAM is at least twice the amount of the value.
Device Operations Clear Custom Status	Erase all custom messages.
Device Operations Clear all remotely-installed messages	Delete all logs created during remote installation.
Device Operations Automatically Display Error Screens On* Off	Set the printer to automatically show existing printer-related messages on the home screen after the printer remains inactive.
Device Operations Honor orientation on fast path copy On Off*	Set the printer to use the Orientation setting under Copy menu when sending quick copy jobs.
Note: An asterisk (*) next to a value indicates the factory default setting.	

Menu item	Description
Scanner Configuration Scanner Manual Registration Print Quick Test Front ADF Registration Flatbed Registration	Align the scan area with the paper location.
Scanner Configuration Edge Erase ADF Edge Erase 0–6 (3*) Flatbed Edge Erase 0–6 (3*)	Set the border size around the scanned image that will be erased.
Scanner Configuration Disable Scanner Enabled* Disabled ADF Disabled	Disable the scanner if it is not working properly.
Scanner Configuration Tiff Byte Order CPU Endianness* Little Endian Big Endian	Determine the byte order of a TIFF-formatted scan output.
Scanner Configuration Exact Tiff Rows Per Strip On* Off	Set the RowsPerStrip tag value of a TIFF-formatted scan output.
Note: An asterisk (*) next to a value indicates the factory default setting.	

Out of Service Erase

Menu item	Description
Erase Printer Memory Printer Memory Last Sanitized Sanitize all information on non-volatile memory Erase all printer and network settings Erase all shortcuts and shortcut settings	Clear all settings and applications that are stored in the printer hard disk.

Visible Home Screen Icons

Menu	Description
<ul style="list-style-type: none"> Copy E-mail Fax Change Language Bookmarks Held Jobs FTP 	Specify which icons to show on the home screen.

About this Printer

Menu item	Description
Asset Tag	Show the serial number of the printer.
Printer's Location	Identify the printer location. The maximum length is 63 characters.
Contact	Personalize the printer name. The maximum length is 63 characters.

Print

Layout

Menu item	Description
Sides <ul style="list-style-type: none"> 1-sided* 2-sided 	Specify whether to print on one side or two sides of the paper.
Flip Style <ul style="list-style-type: none"> Long Edge* Short Edge 	Determine which side of the paper (long edge or short edge) is bound when performing two-sided printing. Note: Depending on the option selected, the printer automatically offsets each printed information of the page to bind the job correctly.
Blank Pages <ul style="list-style-type: none"> Print Do Not Print* 	Print blank pages that are included in a print job.
Collate <ul style="list-style-type: none"> Off [1,1,1,2,2,2]* On [1,2,1,2,1,2] 	Keep the pages of a print job stacked in sequence, particularly when printing multiple copies of the job.
Separator Sheets <ul style="list-style-type: none"> None* Between Copies Between Jobs Between Pages 	Insert blank separator sheets when printing.
Note: An asterisk (*) next to a value indicates the factory default setting.	

Menu item	Description
Separator Sheet Source Tray [x] (1*) Multipurpose Feeder	Specify the paper source for the separator sheet. Note: The multipurpose feeder is available only in some printer models.
Pages per Side Off* 2 pages per side 3 pages per side 4 pages per side 6 pages per side 9 pages per side 12 pages per side 16 pages per side	Print multiple page images on one side of a sheet of paper.
Pages per Side Ordering Horizontal* Reverse Horizontal Vertical Reverse Vertical	Specify the positioning of multiple page images when using Pages per Side. Note: The positioning depends on the number of page images and their page orientation.
Pages per Side Orientation Auto* Landscape Portrait	Specify the orientation of a multiple-page document when using Pages per Side.
Pages per Side Border None* Solid	Print a border around each page image when using Pages per Side.
Copies 1–9999 (1*)	Specify the number of copies for each print job.
Print Area Normal* Fit to page Whole Page	Set the printable area on a sheet of paper.
Note: An asterisk (*) next to a value indicates the factory default setting.	

Setup

Menu item	Description
Printer Language PCL Emulation* PS Emulation	Set the printer language. Note: Setting a default printer language does not prevent a software program from sending print jobs that use another printer language.
Note: An asterisk (*) next to a value indicates the factory default setting.	

Menu item	Description
Resource Save Off* On	Set the printer to handle temporary downloads when it receives a job that requires more than the available memory. Notes: <ul style="list-style-type: none"> • Off sets the printer to retain downloads only until memory is needed. Downloads are deleted to process print jobs. • When set to On and the printer runs out of memory, a Memory Full [38] appears on the display but downloads are not deleted.
Print All Order Alphabetical* Oldest First Newest First	Specify the order in which held and confidential jobs are printed when Print All is selected.
Note: An asterisk (*) next to a value indicates the factory default setting.	

Quality

Menu item	Description
Print Resolution 600 dpi* 1200 Image Q 2400 Image Q 1200 dpi 300 dpi	Set the resolution for the text and images on the printed output. Note: Resolution is determined in dots per inch or image quality.
Pixel Boost Off* Fonts Horizontally Vertically Both directions	Enable more pixels to print in clusters for clarity, in order to enhance text and images.
Toner Darkness 1–10 (8*)	Determine the lightness or darkness of text images.
Halftone Normal* Detail	Enhance the printed output to have smoother lines with sharper edges.
Brightness -6 to 6 (0*)	Adjust the brightness of the printed output.
Contrast 0 to 5 (0*)	Adjust the contrast of the printed output.
Gray Correction Off Auto*	Adjust the contrast enhancement applied to images.
Note: An asterisk (*) next to a value indicates the factory default setting.	

Job Accounting

Note: This menu appears only when a printer hard disk is installed.

Menu item	Description
Job Accounting Off* On	Set the printer to create a log of the print jobs that it receives.
Accounting Log Frequency Daily Weekly Monthly*	Specify how often the printer creates a log file.
Log Action at End of Frequency None* E-mail Current Log E-mail & Delete Current Log Post Current Log Post & Delete Current Log	Specify how the printer responds when the frequency threshold expires. Note: The value defined in Accounting Log Frequency determines when this action is triggered.
Log Near Full Level Off* On	Specify the maximum size of the log file before the printer executes the Log Action at Near Full.
Log Action at Near Full None* E-mail Current Log E-mail & Delete Current Log E-mail & Delete Oldest Log Post Current Log Post & Delete Current Log Post & Delete Oldest Log Delete Current Log Delete Oldest Log Delete All But Current Delete All Logs	Specify how the printer responds when the hard disk is nearly full. Note: The value defined in Log Near Full Level determines when this action is triggered.
Log Action at Full None* E-mail & Delete Current Log E-mail & Delete Oldest Log Post & Delete Current Log Post & Delete Oldest Log Delete Current Log Delete Oldest Log Delete All But Current Delete All Logs	Specify how the printer responds when disk usage reaches the maximum limit (100MB).

Note: An asterisk (*) next to a value indicates the factory default setting.

Menu item	Description
URL to Post Log	Specify where the printer posts job accounting logs.
E-mail Address to Send Logs	Specify the e-mail address to which the printer sends job accounting logs.
Log File Prefix	Specify the prefix for the log file name. Note: The current host name defined in the TCP/IP menu is used as the default log file prefix.
Note: An asterisk (*) next to a value indicates the factory default setting.	

XPS

Menu item	Description
Print Error Pages Off* On	Print a test page that contains information on errors, including XML markup errors.
Minimum Line Width 1–30 (2*)	Set the minimum stroke width of any job printed in 1200 dpi.
Note: An asterisk (*) next to a value indicates the factory default setting.	

PDF

Menu item	Description
Scale to Fit Off* On	Scale the page content to fit the selected paper size.
Annotations Do Not Print* Print	Specify whether to print annotations in the PDF.
Note: An asterisk (*) next to a value indicates the factory default setting.	

PostScript

Menu item	Description
Print PS Error On Off*	Print a test page that contains the PostScript error.
Minimum Line Width 1–30 (2*)	Set the minimum stroke width of any job printed in 1200 dpi.
Lock PS Startup Mode On Off*	Disable the SysStart file.
Note: An asterisk (*) next to a value indicates the factory default setting.	

Menu item	Description
Font Priority Resident* Flash/Disk	Establish the font search order. Notes: <ul style="list-style-type: none"> Resident sets the printer to search its memory for the requested font before searching the flash memory. Flash/Disk sets the printer to search the flash memory for the requested font before searching the printer memory. This menu item appears only when a flash memory is installed.
Wait Timeout Disabled 15–65535 (40*)	Set the printer to wait for additional data before canceling a print job.
Note: An asterisk (*) next to a value indicates the factory default setting.	

PCL

Menu item	Description
Font Source Resident* All	Choose the source which contains the default font selection.
Font Name [List of available fonts]	Select a font from the specified font source.
Symbol Set [List of available symbol set]	Specify the symbol set for each font name. Note: A symbol set is a set of alphabetic and numeric characters, punctuation, and special symbols. Symbol sets support the different languages or specific programs such as math symbols for scientific text.
Pitch 0.08–100 (10*)	Specify the font pitch for scalable monospaced fonts. Note: Pitch refers to the number of fixed-space characters in a horizontal inch of type.
Orientation Portrait* Landscape	Specify the orientation of text and graphics on the page.
Lines per Page 1–255	Specify the number of lines of text for each page printed through the PCL® datastream. Notes: <ul style="list-style-type: none"> This menu item activates vertical escapement that causes the selected number of requested lines to print between the default margins of the page. 60 is the U.S. factory default setting. 64 is the international factory default setting.
Note: An asterisk (*) next to a value indicates the factory default setting.	

Menu item	Description
PCL5 Minimum Line Width 1–30 (2*)	Set the initial minimum stroke width.
PCLXL Minimum Line Width 1–30 (2*)	Notes: <ul style="list-style-type: none"> • Jobs printed in 1200 dpi use the value directly. • Jobs printed in 4800CQ use half the value.
A4 Width 198 mm* 203 mm	Set the width of the logical page on A4-size paper. Note: Logical page is the space on the physical page where data is printed.
Auto CR after LF On Off*	Set the printer to perform a carriage return after a line feed control command. Note: Carriage return is a mechanism that commands the printer to move the position of the cursor to the first position on the same line.
Auto LF after CR On Off*	Set the printer to perform a line feed after a carriage return control command.
Tray Renumber Assign MP Feeder Off* None 0–201 Assign Tray [x] Off* None 0–201 Assign Manual Paper Off* None 0–201 Assign Manual Envelope Off* None 0–201	Configure the printer to work with print drivers or applications that use different source assignments for the paper source.
Tray Renumber View Factory Defaults	Show the factory default setting assigned for each paper source.
Tray Renumber Restore Defaults	Return all tray assignments to factory default values.
Print Timeout Disabled 1–255 (90*)	Set the printer to end a print job after it has been idle for the specified amount of time in seconds.

Note: An asterisk (*) next to a value indicates the factory default setting.

HTML

Menu item	Description
Font Name [List of fonts] (Times*)	Set the font to use for HTML documents.
Font Size 1–255 (12*)	Set the font size to use for HTML documents.
Scale 1–400% (100*)	Scale HTML documents.
Orientation Portrait* Landscape	Set the page orientation for HTML documents.
Margin Size 8–255 mm (19*)	Set the page margin for HTML documents.
Backgrounds Do Not Print Print*	Print background information or graphics for HTML documents.
Note: An asterisk (*) next to a value indicates the factory default setting.	

Image

Menu item	Description
Auto Fit Off On*	Select the best available paper size and orientation setting for an image. Note: When set to On, this menu item overrides the scaling and orientation settings for the image.
Invert Off* On	Invert bitonal monochrome images. Note: This menu item does not apply to GIF or JPEG image formats.
Scaling Best Fit* Anchor Top Left Anchor Center Fit Height/Width Fit Height Fit Width	Adjust the image to fit the printable area. Note: When Auto Fit is set to On, Scaling is automatically set to Best Fit.
Orientation Portrait* Landscape Reverse Portrait Reverse Landscape	Specify the orientation of text and graphics on the page.
Note: An asterisk (*) next to a value indicates the factory default setting.	

Paper

Tray Configuration

Menu item	Description
Default Source Tray [x] (1*) MP Feeder Manual Paper Manual Envelope	Set the paper source for all print jobs. Note: Multipurpose Feeder only appears when Configure MP is set to Cassette.
Paper Size/Type Tray [x] MP Feeder Manual Paper Manual Envelope	Specify the paper size or paper type loaded in each paper source.
Substitute Size Off Statement/A5 Letter/A4 All Listed*	Set the printer to substitute a specified paper size if the requested size is not loaded in any paper source. Notes: <ul style="list-style-type: none"> • Off prompts the user to load the required paper size. • Statement/A5 prints A5-size document on statement when loading statement and statement-size jobs on A5 paper size when loading A5. • Letter/A4 prints A4-size document on letter when loading letter and letter-size jobs on A4 paper size when loading letter. • All Listed substitutes Letter/A4.
Configure MP Cassette* Manual First	Set the printer when to pick paper loaded in the multipurpose feeder. Notes: <ul style="list-style-type: none"> • When set to Cassette, the printer treats the multipurpose feeder like a tray. • When set to Manual, the printer treats the multipurpose feeder like a manual feeder. • When set to First, the printer picks paper from the multipurpose feeder until it is empty, regardless of the required paper source or paper size.

Note: An asterisk (*) next to a value indicates the factory default setting.

Media Configuration

Universal Setup

Menu item	Description
Units of Measure Inches Millimeters	Specify the unit of measurement for the universal paper. Note: Inches is the U.S. factory default setting. Millimeters is the international factory default setting.
Portrait Width 3–14.17 inches (8.50*) 76–359.91 mm (216*)	Set the portrait width of the universal paper.
Portrait Height 3–14.17 inches (14*) 76–359.91 mm (356*)	Set the portrait height of the universal paper.
Feed Direction Short Edge* Long Edge	Set the printer to pick paper from the short edge or long edge direction. Note: Long Edge appears only when the longest edge is shorter than the maximum width supported.
Note: An asterisk (*) next to a value indicates the factory default setting.	

Custom Scan Sizes

Menu item	Description
Custom Scan Size [x] Scan Size Name Width 1–8.50 inches (8.50*) 25–216 mm (216*) Height 1–14 inches (14*) 25–356 mm (297*) Orientation Portrait* Landscape 2 scans per side Off* On	Assign a scan size name and configure the scan settings.

Media Types

Menu item	Description
Plain	Specify the texture and weight of the paper loaded.
Card Stock	Select from the following options:
Transparency	Paper Texture
Recycled	Smooth
Labels	Normal*
Bond	Rough
Envelope	Paper Weight
Rough Envelope	Light
Letterhead	Normal*
Preprinted	Heavy
Colored Paper	
Light	
Heavy	
Rough/Cotton	
Custom Type [x]	

Note: An asterisk (*) next to a value indicates the factory default setting.

Copy

Copy Defaults

Menu item	Description
Content Type Text Text/Photo* Photo Graphics	Improve the output result based on the content of the original document.
Content Source Black and White Laser Color Laser* Inkjet Photo/Film Magazine Newspaper Press Other	Improve the output result based on the source of the original document.
Sides 1 sided to 1 sided* 1 sided to 2 sided	Specify the scanning behavior based on the original document.

Note: An asterisk (*) next to a value indicates the factory default setting.

Menu item	Description
Separator Sheets None* Between Copies Between Jobs Between Pages	Specify whether to insert blank separator sheets when printing.
Separator Sheet Source Tray [x] (1*) MP Feeder	Specify the paper source for the separator sheet.
Pages per Side Off* 2 Portrait pages 4 Portrait pages 2 Landscape pages 4 Landscape pages	Specify the number of page images to print on one side of a sheet of paper.
Print Page Borders On Off*	Place a border around each image when printing multiple pages on a single page.
Collate Off [1,1,1,2,2,2] On [1,2,1,2,1,2]*	Print multiple copies in sequence.
“Copy from” Size [List of paper sizes]	Set the paper size of the original document. Notes: <ul style="list-style-type: none"> • Letter is the U.S. factory default setting. A4 is the international factory default setting. • This menu item may vary depending on your printer model.
“Copy to” Source Tray [x] (1*) MP Feeder Auto Size Match	Specify the paper source for the copy job.
Darkness 1–9 (5*)	Adjust the darkness of the scanned image.
Number of Copies 1–9999 (1*)	Specify the number of copies.
Overlay Confidential Copy Draft Urgent Custom Off*	Specify the overlay text printed on each page of the copy job.
Note: An asterisk (*) next to a value indicates the factory default setting.	

Menu item	Description
Custom Overlay	Type a custom overlay text.
Note: An asterisk (*) next to a value indicates the factory default setting.	

Advanced Imaging

Menu item	Description
Color Dropout None* Red Green Blue Default Red Threshold 0–255 (128*) Default Green Threshold 0–255 (128*) Default Blue Threshold 0–255 (128*)	Specify which color to drop during scanning, and adjust the dropout setting for that color.
Contrast Best for Content* 0 1 2 3 4 5	Specify the contrast of the output.
Background Removal Background detection Content-based Fixed Level -4 to 4 (0*)	Adjust the amount of background visible on a scanned image.
Auto Center Off* On	Align the content at the center of the page.
Mirror Image Off* On	Create a mirror image of the original document.
Negative Image Off* On	Create a negative image of the original document.
Note: An asterisk (*) next to a value indicates the factory default setting.	

Menu item	Description
Shadow Detail -4 to 4 (0*)	Adjust the amount of shadow detail visible on a scanned image.
Scan Edge to Edge Off* On	Allow edge-to-edge scanning of the original document.
Sharpness 1–5 (3*)	Adjust the sharpness of a scanned image.
Note: An asterisk (*) next to a value indicates the factory default setting.	

Admin Controls

Menu item	Description
Transparency Separators Off On*	Insert a blank sheet between transparencies.
Allow Priority Copies On* Off	Interrupt a print job to copy a page or document.
Note: An asterisk (*) next to a value indicates the factory default setting.	

Fax

Fax Mode

Menu item	Description
Fax Mode Fax* Disabled	Select a fax mode.
Note: An asterisk (*) next to a value indicates the factory default setting.	

Fax Setup

General Fax Settings

Menu item	Description
Fax Name	Identify your fax machine.
Fax Number	Identify your fax number.
Note: An asterisk (*) next to a value indicates the factory default setting.	

Menu item	Description
Fax ID Fax Name Fax Number*	Notify fax recipients of your fax name or fax number.
Enable Manual Fax Off* On	Set the printer to fax manually. Notes: <ul style="list-style-type: none"> • This menu item does not appear if Fax Transport is set to T.38 or G711. • This menu item requires a line splitter and a telephone handset. • Use a regular telephone line to answer an incoming fax job and to dial a fax number. • To go directly to the Manual Fax function, touch # and 0 on the keypad.
Memory Use All receive Mostly receive Equal* Mostly send All send	Set the amount of internal printer memory allocated for faxing. Note: This menu item prevents memory buffer conditions and failed faxes.
Cancel Faxes Allow* Don't Allow	Cancel outgoing faxes before they are transmitted, or cancel incoming faxes before they finish printing.
Caller ID Off On* Alternate	Show the telephone number of the person sending the fax.
Fax Number Masking Off* From Left From Right	Specify the format for masking an outgoing fax number.
Digits to Mask 0–58 (0*)	Specify the number of digits to mask in an outgoing fax number.
Enable Line Connected Detection Off On*	Determine whether a telephone line is connected to the printer. Notes: <ul style="list-style-type: none"> • Detection takes place when turning on the printer and before each call. • This menu item does not appear if Fax Transport is set to T.38.
Enable Line In Wrong Jack Detection Off* On	Determine whether a telephone line is connected to the correct port on the printer. Notes: <ul style="list-style-type: none"> • Detection takes place when turning on the printer and before each call. • This menu item does not appear if Fax Transport is set to T.38.
Note: An asterisk (*) next to a value indicates the factory default setting.	

Menu item	Description
Enable Extension in Use Support Off On*	Determine whether a telephone line is used by another device such as another phone on the same line. Notes: <ul style="list-style-type: none"> • This menu item is monitored continuously after turning on the printer. • This menu item does not appear if Fax Transport is set to T.38.
Optimize Fax Compatibility	Configure the printer fax functionality for optimal compatibility with other fax machines.
Note: An asterisk (*) next to a value indicates the factory default setting.	

Fax Send Settings

Menu item	Description
Resolution Standard* Fine Super Fine Ultra Fine	Set the resolution of the scanned image. Note: A higher resolution increases fax transmission time and requires higher memory.
Original Size [List of paper sizes]	Specify the size of the original document. Note: Mixed Sizes is the U.S. factory default setting. A4 is the international factory default setting.
Orientation Portrait* Landscape	Specify the orientation of the original document.
Sides Off* Long Edge Short Edge	Specify the page orientation of text and graphics when scanning a two-sided document.
Content Type Text* Text/Photo Photo Graphics	Improve the output result based on the content of the original document.
Content Source Black and White Laser Color Laser* Inkjet Photo/Film Magazine Newspaper Press Other	Improve the output result based on the source of the original document.
Note: An asterisk (*) next to a value indicates the factory default setting.	

Menu item	Description
Darkness 1–9 (5*)	Adjust the darkness of the scanned image.
Behind a PABX On Off*	Set the printer to dial a fax number without waiting to recognize the dial tone. Note: Private Automated Branch Exchange (PABX) is a telephone network that allows a single access number to offer multiple lines to outside callers.
Dial Mode Tone* Pulse	Specify the dial mode for incoming or outgoing faxes.
Note: An asterisk (*) next to a value indicates the factory default setting.	

Advanced Imaging

Menu item	Description
Color Dropout None* Red Green Blue Default Red Threshold 0–255 (128*) Default Green Threshold 0–255 (128*) Default Blue Threshold 0–255 (128*)	Specify which color to drop during scanning, and adjust the dropout setting for that color.
Contrast Best for Content* 0 1 2 3 4 5	Set the contrast of the output.
Background Removal Background Detection Content-based* Fixed Level -4 to 4 (0*)	Adjust the amount of background visible on a scanned image. Note: If you want to remove the background color from the original document, then set Background Detection to Content-based. If you want to remove image noise from a photo, then set Background Detection to Fixed.
Mirror Image On Off*	Create a mirror image of the original document.
Note: An asterisk (*) next to a value indicates the factory default setting.	

Menu item	Description
Negative Image On Off*	Create a negative image of the original document.
Shadow Detail -4 to 4 (0*)	Adjust the amount of shadow detail visible on a scanned image.
Scan Edge to Edge On Off*	Allow edge-to-edge scanning of the original document.
Sharpness 1–5 (3*)	Adjust the sharpness of the scanned image.
Temperature -4 to 4 (0*)	Specify whether to generate a cooler or warmer output.
Note: An asterisk (*) next to a value indicates the factory default setting.	

Admin Controls

Menu item	Description
Automatic Redial 0–9 (5*)	Adjust the number of redial attempts based on the activity levels of recipient fax machines.
Redial Frequency 1–200 minutes (3*)	Increase the time between redial attempts to increase the chance of sending fax successfully.
Enable ECM On* Off	Activate Error Correction Mode (ECM) for fax jobs. Note: ECM detects and corrects errors in the fax transmission process that are caused by telephone line noise and poor signal strength.
Enable Fax Scans On* Off	Fax documents that are scanned at the printer.
Driver to Fax On* Off	Allow the print driver to send fax.
Allow Save as Shortcut On* Off	Save fax numbers as shortcuts in the printer.
Max Speed 33600* 14400 9600 4800 2400	Set the maximum speed for sending fax.
Note: An asterisk (*) next to a value indicates the factory default setting.	

Menu item	Description
Enable Color Fax Scans Off by default* On by default Never use Always use	Enable color scans for fax.
Auto Convert Color Faxes to Mono Faxes On* Off	Convert all outgoing color faxes to black and white.
Confirm Fax Number Off* On	Ask the user to confirm the fax number.
Dial Prefix	Set a dialing prefix.
Note: An asterisk (*) next to a value indicates the factory default setting.	

Fax Receive Settings

Menu item	Description
Rings to Answer 1–25 (3*)	Set the number of rings for incoming fax.
Auto Reduction Off On*	Scale incoming fax to fit on the page.
Paper Source Tray [x] MP Feeder Auto*	Set the paper source for printing incoming fax. Note: MP Feeder appears only when an optional 650-sheet duo tray is installed.
Sides Off* On	Print on both sides of the paper.
Separator Sheets None* Before Job After Job	Specify whether to insert blank separator sheets when printing.
Separator Sheet Source Tray [x] (1*) MP Feeder	Specify the paper source for the separator sheet. Note: MP Feeder appears only when an optional 650-sheet duo tray is installed.
Output Bin Standard Bin	Specify the output bin for received faxes.
Note: An asterisk (*) next to a value indicates the factory default setting.	

Menu item	Description
Fax Footer On Off*	Print the transmission information at the bottom of each page from a received fax.
Fax Footer Time Stamp Receive* Print	Print the time stamp at the bottom of each page from a received fax.
Note: An asterisk (*) next to a value indicates the factory default setting.	

Admin Controls

Menu item	Description
Enable Fax Receive Off On*	Set the printer to receive fax.
Enable Color Fax Receive Off On*	Set the printer to receive fax in color.
Enable Caller ID Off On*	Show the number that is sending the incoming fax.
Block No Name Fax Off* On	Block incoming faxes sent from devices with no station ID or fax ID specified.
Answer On All Rings* Single Ring Only Double Ring Only Triple Ring Only Single or Double Rings Only Single or Triple Rings Only Double or Triple Rings Only	Set a distinctive ring pattern for incoming fax.
Auto Answer Off On*	Set the printer to receive fax automatically.
Manual Answer Code 0–9 (9*)	Manually enter a code on the telephone number pad to begin receiving fax. Notes: <ul style="list-style-type: none"> • This menu item appears only when the printer shares a line with a telephone. • This menu item appears only when you set the printer to receive fax manually.
Note: An asterisk (*) next to a value indicates the factory default setting.	

Menu item	Description
Fax Forwarding Print* Print and Forward Forward	Specify how to forward received fax.
Forward to Destination [x] Type Shortcut Number	Specify the destination for forwarding received fax.
Confirmation E-mail	Send a confirmation e-mail when fax forwarding is successful. Note: The e-mail is sent only when forwarding to FTP or Network Share destinations.
Max Speed 33600* 14400 9600 4800 2400	Set the maximum speed for transmitting fax.
Note: An asterisk (*) next to a value indicates the factory default setting.	

Fax Cover Page

Menu item	Description
Fax Cover Page Off by Default* On by Default Never Use Always Use	Configure the settings for the fax cover page.
Include To field Off* On	
Include From field Off* On	
From	
Include Message Field Off* On	
Message:	
Include Logo Off* On	
Include Footer [x] Off* On	
Footer [x]	
Note: An asterisk (*) next to a value indicates the factory default setting.	

Fax Log Settings

Menu item	Description
Transmission Log Frequency Always* Never Only for Error	Specify how often the printer creates a transmission log.
Transmission Log Action Print Off On* E-mail Off* On	
Note: An asterisk (*) next to a value indicates the factory default setting.	

Menu item	Description
Receive Error Log Print Never* Print on Error	Print a log for fax-receive failures.
Auto Print Logs On* Off	Print all fax activity.
Log Paper Source Tray [x] (1*) Multipurpose Feeder	Specify the paper source for printing logs.
Logs Display Remote Fax Name* Dialed Number	Identify the sender by remote fax name or fax number.
Enable Job Log On* Off	View a summary of all fax jobs.
Enable Call Log On* Off	View a summary of fax dialing history.
Log Output Bin Standard Bin* Bin [x]	Specify the output bin for printed logs.
Note: An asterisk (*) next to a value indicates the factory default setting.	

Speaker Settings

Menu item	Description
Speaker Mode Always Off Always On On until Connected*	Set the fax speaker mode.
Speaker Volume Low High*	Adjust the fax speaker volume.
Ringer Volume Off On*	Enable the ringer volume.
Note: An asterisk (*) next to a value indicates the factory default setting.	

E-mail

E-mail Setup

Menu item	Description
Primary SMTP Gateway	Type the IP address or host name of the primary SMTP server for sending e-mail.
Primary SMTP Gateway Port 1–65535 (25*)	Enter the port number of the primary SMTP server.
Secondary SMTP Gateway	Type the server IP address or host name of your secondary or backup SMTP server.
Secondary SMTP Gateway Port 1–65535 (25*)	Enter the server port number of your secondary or backup SMTP server.
SMTP Timeout 5–30 seconds (30*)	Set the time before the printer times out if the SMTP server does not respond.
Reply Address	Specify a reply address in the e-mail.
Always use SMTP default Reply Address On* Off	Always use the default reply address in the SMTP server.
Use SSL/TLS Disabled* Negotiate Required	Specify whether to send e-mail using an encrypted link.
Require Trusted Certificate Off On*	Require a trusted certificate when accessing the SMTP server.
SMTP Server Authentication No authentication required* Login / Plain NTLM CRAM-MD5 Digest-MD5 Kerberos 5	Set the authentication type for the SMTP server.
Device-Initiated E-mail None* Use Device SMTP Credentials	Specify whether credentials are required for device-initiated e-mail.
Note: An asterisk (*) next to a value indicates the factory default setting.	

Menu item	Description
User-Initiated E-mail None* Use Device SMTP Credentials Use Session User ID and Password Use Session E-mail address and Password Prompt user	Specify whether credentials are required for user-initiated e-mail.
Use Active Directory Device Credentials Off On*	Enable user credentials and group designations to connect to the SMTP server.
Device Userid	Specify the user ID and password to connect to the SMTP server.
Device Password	
Kerberos 5 REALM	Specify the realm for the Kerberos 5 authentication protocol.
NTLM Domain	Specify the domain name for the NTLM security protocol.
Disable "SMTP server not set up" error Off* On	Hide the "SMTP server not set up" error message.
Note: An asterisk (*) next to a value indicates the factory default setting.	

E-mail Defaults

Menu item	Description
Subject	Specify the e-mail subject and message.
Message	
File Name	Specify the file name for the scanned image.
Format PDF (.pdf)* TIFF (.tif) JPEG (.jpg) XPS (.xps) TXT (.txt) RTF (.rtf) DOCX (.docx)	Specify the file format for the scanned image.
Note: An asterisk (*) next to a value indicates the factory default setting.	

Menu item	Description
<p>Global OCR Settings</p> <ul style="list-style-type: none"> Recognized Languages Auto Rotate Despeckle Auto Contrast Enhance 	<p>Configure the settings for optical character recognition (OCR).</p> <p>Note: This menu item appears only if you have purchased and installed an OCR solution.</p>
<p>PDF Settings</p> <ul style="list-style-type: none"> PDF Version <ul style="list-style-type: none"> 1.3 1.4 1.5* 1.6 1.7 Archival Version <ul style="list-style-type: none"> A-1a* A-1b Highly Compressed <ul style="list-style-type: none"> Off* On Secure <ul style="list-style-type: none"> Off* On Searchable <ul style="list-style-type: none"> Off* On Archival (PDF/A) <ul style="list-style-type: none"> Off* On 	<p>Set the PDF format of the scanned image.</p>
<p>Content Type</p> <ul style="list-style-type: none"> Text Text/Photo* Photo Graphics 	<p>Improve the output result based on the content of the original document.</p>
<p>Content Source</p> <ul style="list-style-type: none"> Black and White Laser* Color Laser Inkjet Photo/Film Magazine Newspaper Press Other 	<p>Improve the output result based on the original document.</p>

Note: An asterisk (*) next to a value indicates the factory default setting.

Menu item	Description
Color Black and White Gray Color* Auto	Specify the color when scanning an image.
Resolution 75 dpi 150 dpi* 200 dpi 300 dpi 400 dpi 600 dpi	Set the resolution of the scanned image.
Darkness -4 to 4 (0*)	Adjust the darkness of the scanned image.
Orientation Portrait* Landscape	Specify the orientation of text and graphics on the page.
Original Size [List of paper sizes]	Set the paper size of the original document. Note: Mixed Sizes is the factory default setting.
Sides Off* Long Edge Short Edge	Specify the page orientation of text and graphics when scanning a two-sided document.
Note: An asterisk (*) next to a value indicates the factory default setting.	

Advanced Imaging

Menu item	Description
Color Balance Cyan to Red -4 to 4 (0*) Magenta to Green -4 to 4 (0*) Yellow to Blue -4 to 4 (0*)	Adjust the color intensity during scanning.
Note: An asterisk (*) next to a value indicates the factory default setting.	

Menu item	Description
Color Dropout Color Dropout None* Red Green Blue Default Red Threshold 0–255 (128*) Default Green Threshold 0–255 (128*) Default Blue Threshold 0–255 (128*)	Specify which color to drop during scanning, and adjust the dropout setting for that color.
Auto Color Detect Color Sensitivity 1–9 (5*) Area Sensitivity 1–9 (5*) E-mail Bit Depth 1 bit* 8 bit	Set the amount of color that the printer detects from the original document. Note: This menu item appears only when Color is set to Auto.
JPEG Quality Best for content* 5–95	Set the quality of a JPEG-format scanned image. Notes: <ul style="list-style-type: none"> • 5 reduces the file size, but lessens the image quality. • 95 provides the best image quality, but produces a large file size.
Contrast Best for content* 0 1 2 3 4 5	Specify the contrast of the output.
Background Removal Background Detection Content-based* Fixed Level -4 to 4 (0*)	Adjust the amount of background visible on a scanned image. Note: If you want to remove the background color from the original document, then set Background Detection to Content-based. If you want to remove image noise from a photo, then set Background Detection to Fixed.
Mirror Image Off* On	Create a mirror image of the original document.
Note: An asterisk (*) next to a value indicates the factory default setting.	

Menu item	Description
Negative Image Off* On	Create a negative image of the original document.
Shadow Detail -4 to 4 (0*)	Adjust the amount of shadow detail visible on a scanned image.
Scan Edge to Edge Off* On	Allow edge-to-edge scanning of the original document.
Sharpness 1–5 (3*)	Adjust the sharpness of a scanned image.
Temperature -4 to 4 (0*)	Specify whether to generate a cooler or warmer output.
Blank Pages Blank Page Removal Blank Page Sensitivity	Specify whether to include blank pages.
Note: An asterisk (*) next to a value indicates the factory default setting.	

Admin Controls

Menu item	Description
Max E-mail Size 0–65535 (0*)	Set the allowable file size for each e-mail.
Size Error Message	Specify an error message that the printer sends when an e-mail exceeds its allowable file size. Note: You can type up to 1024 characters.
Limit Destinations	Limit sending of e-mail only to the specified list of domain names. Note: Use a comma to separate each domain.
Send Me a Copy Never appears* On by Default Off by Default Always On	Send a copy of the e-mail to yourself.
Limit E-mail Recipients Off* On	Limit the number of e-mail recipients.
Use cc:/bcc: Off* On	Enable carbon copy and blind carbon copy in e-mail.
Note: An asterisk (*) next to a value indicates the factory default setting.	

Menu item	Description
Use Multi-Page TIFF On* Off	Choose between single- and multiple-page TIFF files.
TIFF Compression LZW* JPEG	Set a compression option for TIFF files.
Text Default 5–95 (75*)	Set the quality of text on a scanned image.
Text/Photo Default 5–95 (75*)	Set the quality of text or photo on a scanned image.
Photo Default 5–95 (50*)	Set the quality of a photo on a scanned image.
Transmission Log Print log* Do Not Print Log Print Only For Error	Print a log for successful e-mail transmission.
Log Paper Source Tray [x] (1*) Multipurpose Feeder	Specify the paper source for printing logs.
Custom Job Scanning Off* On	Turn on scanning of custom jobs by default. Note: This menu item appears only when a hard disk is installed.
Scan Preview Off On*	Show the scan preview on the display. Note: This menu item appears only when a printer hard disk is installed.
Allow Save as Shortcut Off On*	Save e-mail addresses as shortcuts. Note: When set to Off, the Save As Shortcut button does not appear on the e-mail Destination screen.
E-mail Images Sent As Attachment* Web Link	Specify how to send the images in e-mail.
Reset E-mail Information After Sending Off On*	Restore the default e-mail information after sending an e-mail.
Note: An asterisk (*) next to a value indicates the factory default setting.	

Web Link Setup

Menu item	Description
Server	Set the printer to send e-mail as a web link.
Login	
Password	
Path	
File Name	
Web Link	

FTP

FTP Defaults

Menu item	Description
Format PDF (.pdf)* TIFF (.tif) JPEG (.jpg) XPS (.xps) TXT (.txt) RTF (.rtf) DOCX (.docx)	Specify the file format for the scanned image. Note: The menu items may vary depending on your printer model.
Global OCR Settings Recognized Languages Auto Rotate Despeckle Auto Contrast Enhance	Configure the settings for optical character recognition (OCR). Note: This menu appears only if you have purchased and installed an OCR solution.
Note: An asterisk (*) next to a value indicates the factory default setting.	

Menu item	Description
PDF Settings PDF Version 1.3 1.4 1.5* 1.6 1.7 Archival Version A-1a* A-1b Highly Compressed Off* On Secure Off* On Searchable Off* On Archival (PDF/A) Off* On	Set the PDF format for the scanned image.
Content Type Text Text/Photo* Graphics Photo	Improve the output result based on the content of the original document.
Content Source Black and White Laser Color Laser* Inkjet Photo/Film Magazine Newspaper Press Other	Improve the output result based on the source of the original document.
Color Black and White Gray Color* Auto	Specify the color when scanning an image.
Note: An asterisk (*) next to a value indicates the factory default setting.	

Menu item	Description
Resolution 75 dpi 150 dpi* 200 dpi 300 dpi 400 dpi 600 dpi	Set the resolution of the scanned image.
Darkness -4 to 4 (0*)	Adjust the darkness of the scanned image.
Orientation Portrait* Landscape	Specify the orientation of text and graphics on the page.
Original Size [List of paper sizes]	Set the paper size of the original document. Notes: <ul style="list-style-type: none"> • Letter is the U.S. factory default setting. A4 is the international factory default setting. • The menu items may vary depending on your printer model.
Sides Off* Long Edge Short Edge	Specify the page orientation of text and graphics when scanning a two-sided document.
File Name	Specify the file name of the scanned image.
Note: An asterisk (*) next to a value indicates the factory default setting.	

Advanced Imaging

Menu item	Description
Color Balance Cyan to Red -4 to 4 (0*) Magenta to Green -4 to 4 (0*) Yellow to Blue -4 to 4 (0*)	Adjust the color intensity during scanning.
Note: An asterisk (*) next to a value indicates the factory default setting.	

Menu item	Description
Color Dropout Color Dropout None* Red Green Blue Default Red Threshold 0–255 (128*) Default Green Threshold 0–255 (128*) Default Blue Threshold 0–255 (128*)	Specify which color to drop during scanning, and adjust the dropout setting for that color.
Auto Color Detect Color Sensitivity 1–9 (5*) Area Sensitivity 1–9 (5*) FTP Bit Depth 1 bit* 8 bit	Set the amount of color that the printer detects from the original document. Note: This menu item appears only when Color is set to Auto.
JPEG Quality Best for content* 5–95	Set the quality of a JPEG-format image. Notes: <ul style="list-style-type: none"> • 5 reduces the file size, but lessens the image quality. • 90 provides the best image quality, but produces a large file size.
Contrast Best for content* 0 1 2 3 4 5	Specify the contrast of the output.
Background Removal Background Detection Content-based* Fixed Level -4 to 4 (0*)	Adjust the amount of background visible on a scanned image. Note: If you want to remove the background color from the original document, then set Background Detection to Content-based. If you want to remove image noise from a photo, then set Background Detection to Fixed.
Mirror Image Off* On	Create a mirror image of the original document.
Note: An asterisk (*) next to a value indicates the factory default setting.	

Menu item	Description
Negative Image Off* On	Create a negative image of the original document.
Shadow Detail -4 to 4 (0*)	Adjust the amount of shadow detail visible on a scanned image.
Scan Edge to Edge Off* On	Allow edge-to-edge scanning of the original document.
Sharpness 1–5 (3*)	Adjust the sharpness of a scanned image.
Temperature -4 to 4 (0*)	Specify whether to generate a cooler or warmer output.
Blank Pages Blank Page Removal Blank Page Sensitivity	Specify whether to include blank pages.
Note: An asterisk (*) next to a value indicates the factory default setting.	

Admin Controls

Menu item	Description
Text Default 5–95 (75*)	Set the quality of text on a scanned image.
Text/Photo Default 5–95 (75*)	Set the quality of text or photo image on a scanned image.
Photo Default 5–95 (50*)	Set the quality of a photo image on a scanned image.
Use Multi-Page TIFF On* Off	Choose between single- and multiple-page TIFF files.
TIFF Compression LZW* JPEG	Set a compression option for TIFF files.
Transmission Log Print Log* Do Not Print Log Print Only For Error	Print a log for successful FTP scan transmission.
Log Paper Source Tray [x] (1*) Multipurpose Feeder	Specify the paper source for printing FTP logs.
Note: An asterisk (*) next to a value indicates the factory default setting.	

Menu item	Description
Custom Job Scanning Off* On	Turn on scanning of custom jobs by default. Note: This menu item appears only when a hard disk is installed.
Scan Preview Off On*	Show a preview of the scan on the display. Note: This menu item appears only when a hard disk is installed.
Allow Save as Shortcut Off On*	Save custom FTP settings as shortcuts.
Note: An asterisk (*) next to a value indicates the factory default setting.	

Network/Ports

Network Overview

Menu item	Description
Active Adapter Auto* Standard Network	Specify how a network is connected.
Network Status	Show the connection status of the printer network.
Display Network Status on Printer On* Off	Show the network status on the display.
Speed, Duplex	Show the speed of the currently active network card.
IPv4	Show the IPv4 address.
All IPv6 Addresses	Show all IPv6 addresses.
Reset Print Server	Reset all active network connections to the printer. Note: This setting removes all network configuration settings.
Network Job Timeout Off On* (90 seconds)	Set the time before the printer cancels a network print job.
Banner Page Off* On	Print a banner page.
Scan to PC Port Range 9751:12000*	Specify a valid port range for printers that are behind a port blocking firewall.
Note: An asterisk (*) next to a value indicates the factory default setting.	

Wireless

Note: This menu is available only in printers connected to a Wi-Fi network or printers that have a wireless network adapter.

Menu item	Description
Setup Using Mobile App	Configure the Wi-Fi connection using Lexmark Mobile Assistant.
Setup On Printer Panel Choose Network Add Wi-Fi Network Network Name Network Mode Infrastructure Wireless Security Mode Disabled* WEP WPA2/WPA - Personal WPA2 - Personal 802.1x - RADIUS	Configure the Wi-Fi connection using the control panel. Note: 802.1x - RADIUS can be configured only from the Embedded Web Server.
Wi-Fi Protected Setup WPS Auto Detect Off On* Start Push Button Method Start PIN Method	Establish a Wi-Fi network and enable network security. Notes: <ul style="list-style-type: none"> • WPS Auto Detect appears only when the Wireless Security Mode is set to WEP. • Start Push-Button Method connects the printer to a Wi-Fi network when buttons on both the printer and the access point (wireless router) are pressed within a given time. • Start PIN Method connects the printer to a Wi-Fi network when a PIN on the printer is entered into the wireless settings of the access point.
Network Mode BSS Type Infrastructure*	Specify the network mode.
Enable Wi-Fi Direct On Off*	Enable Wi-Fi Direct-capable devices to connect directly to the printer.
Compatibility 802.11b/g/n (2.4GHz)* 802.11a/b/g/n/ac (2.4GHz/5GHz) 802.11a/n/ac (5GHz)	Specify the standard for the Wi-Fi network. Note: 802.11a/b/g/n/ac (2.4GHz/5GHz) and 802.11a/n/ac (5GHz) only appear when a Wi-Fi option is installed.
Wireless Security Mode Disabled* WEP WPA2/WPA-Personal WPA2-Personal 802.1x - RADIUS	Set the security mode for connecting the printer to Wi-Fi devices. Note: 802.1x - RADIUS can be configured only from the Embedded Web Server.

Menu item	Description
WEP Authentication Mode Auto* Open Shared	Set the type of Wireless Encryption Protocol (WEP) for the printer. Note: This menu item appears only when the Wireless Security Mode is set to WEP.
Set WEP Key	Specify a WEP password for secure Wi-Fi connection.
WPA2/WPA Personal AES	Enable Wi-Fi security through Wi-Fi Protected Access (WPA). Note: This menu item appears only when the Wireless Security Mode is set to WPA2/WPA-Personal.
Set Pre-Shared Key	Set the password for secure Wi-Fi connection.
WPA2-Personal AES	Enable Wi-Fi security through WPA2. Note: This menu item appears only when the Wireless Security Mode is set to WPA2-Personal.
802.1x Encryption Mode WPA+ WPA2*	Enable Wi-Fi security through 802.1x standard. Notes: <ul style="list-style-type: none"> • This menu item appears only when the Wireless Security Mode is set to 802.1x - RADIUS. • 802.1x - RADIUS can be configured only from the Embedded Web Server.
IPv4 Enable DHCP On* Off Set Static IP Address IP Address Netmask Gateway	Enable and configure IPv4 settings in the printer.
IPv6 Enable IPv6 On* Off Enable DHCPv6 On Off* Stateless Address Autoconfiguration On* Off DNS Server Address Manually Assigned IPv6 Address Manually Assigned IPv6 Router Address Prefix All IPv6 Addresses All IPv6 Router Addresses	Enable and configure IPv6 settings in the printer.

Menu item	Description
Network Address UAA LAA	View the network addresses.
PCL SmartSwitch Off On*	Set the printer to switch automatically to PCL emulation when a print job requires it, regardless of the default printer language. Note: If PCL SmartSwitch is off, then the printer does not examine incoming data and uses the default printer language specified in the Setup menu.
PS SmartSwitch Off On*	Set the printer to switch automatically to PS emulation when a print job requires it, regardless of the default printer language. Note: If PS SmartSwitch is off, then the printer does not examine incoming data and uses the default printer language specified in the Setup menu.
Job Buffering On Off*	Temporarily store print jobs in the printer hard disk before printing. Note: This menu item appears only when a hard disk is installed.
Mac Binary PS Auto* On Off	Set the printer to process Macintosh binary PostScript print jobs. Notes: <ul style="list-style-type: none"> • On processes raw binary PostScript print jobs. • Off filters print jobs using the standard protocol.

Ethernet

Menu item	Description
Network Speed	Show the speed of an active network adapter.
IPv4 Enable DHCP On* Off	Enable Dynamic Host Configuration Protocol (DHCP). Note: DHCP is a standard protocol that allows a server to distribute IP addressing and configuration information dynamically to clients.
IPv4 Set Static IP Address IP Address Netmask Gateway	Set the static IP address of your printer.
IPv6 Enable IPv6 Off On*	Enable IPv6 in the printer.
Note: An asterisk (*) next to a value indicates the factory default setting.	

Menu item	Description
IPv6 Enable DHCPv6 Off* On	Enable DHCPv6 in the printer.
IPv6 Stateless Address Autoconfiguration Off On*	Set the network adapter to accept the automatic IPv6 address configuration entries provided by a router.
IPv6 DNS Server Address	Specify the DNS server address.
IPv6 Manually Assigned IPv6 Address	Assign the IPv6 address.
IPv6 Manually Assigned IPv6 Router	Assign the IPv6 address.
IPv6 Address Prefix 0–128 (64*)	Specify the address prefix.
IPv6 All IPv6 Addresses	Show all IPv6 addresses.
IPv6 All IPv6 Router Addresses	Show all IPv6 router addresses.
Network Address UAA LAA	Show the printer Media Access Control (MAC) addresses: Locally Administered Address (LAA) and Universally Administered Address (UAA). Note: You can change the printer LAA manually.
PCL SmartSwitch Off On*	Set the printer to switch automatically to PCL emulation when a print job requires it, regardless of the default printer language. Note: If PCL SmartSwitch is off, then the printer does not examine incoming data and uses the default printer language specified in the Setup menu.
PS SmartSwitch Off On*	Set the printer to switch automatically to PS emulation when a print job requires it, regardless of the default printer language. Note: If PS SmartSwitch is off, then the printer does not examine incoming data and uses the default printer language specified in the Setup menu.
Mac Binary PS Auto* On Off	Set the printer to process Macintosh binary PostScript print jobs. Notes: <ul style="list-style-type: none"> • On processes raw binary PostScript print jobs. • Off filters print jobs using the standard protocol.
Note: An asterisk (*) next to a value indicates the factory default setting.	

Menu item	Description
Energy Efficient Ethernet Off On*	Reduce power consumption when the printer does not receive data from the Ethernet network.
Note: An asterisk (*) next to a value indicates the factory default setting.	

TCP/IP

Note: This menu appears only in network printers or printers attached to print servers.

Menu item	Description
Set Hostname	Set the current TCP/IP host name.
Domain Name	Set the domain name.
Allow DHCP/BOOTP to update NTP server On* Off	Allow the DHCP and BOOTP clients to update the NTP settings of the printer.
Zero Configuration Name	Specify a service name for the zero configuration network.
Enable Auto IP On* Off	Assign an IP address automatically.
DNS Address	Specify the current Domain Name System (DNS) server address.
Backup DNS Address	Specify the backup DNS server addresses.
Backup DNS Address 2	
Backup DNS Address 3	
Domain Search Order	Specify a list of domain names to locate the printer and its resources that reside in different domains on the network.
Enable DDNS On* Off	Update Dynamic DNS settings.
DDNS TTL	Specify the current DDNS settings.
Default TTL	
DDNS Refresh Time	
Enable mDNS Off On*	Update multicast DNS settings.
WINS Address	Specify a server address for Windows Internet Name Service (WINS).
Note: An asterisk (*) next to a value indicates the factory default setting.	

Menu item	Description
Enable BOOTP Off* On	Allow the BOOTP to assign a printer IP address.
Restricted Server List	Specify an IP address for the TCP connections. Notes: <ul style="list-style-type: none"> • Use a comma to separate each IP address. • You can add up to 50 IP addresses.
Restricted Server List Options Block All Ports* Block Printing Only Block Printing and HTTP Only	Specify how the IP addresses in the list can access the printer functionality.
MTU	Specify a maximum transmission unit (MTU) parameter for the TCP connections.
Raw Print Port 1–65535 (9100*)	Specify a raw port number for printers connected on a network.
Outbound Traffic Maximum Speed Off* 100 to 1000000	Enable the printer maximum transfer rate.
Enable SSLv2 Off* On	Enable the SSLv2 protocol.
Enable SSLv3 Off* On	Enable the SSLv3 protocol.
Enable TLSv1.0 Off On*	Enable the TLSv1.0 protocol.
Enable TLSv1.1 Off On*	Enable the TLSv1.1 protocol.
SSL Cipher List	Specify the cipher algorithms to use for the SSL or the TLS connections.
Resolve Hostnames Using DNS Off On*	Use DNS to resolve host names to IP addresses.
Note: An asterisk (*) next to a value indicates the factory default setting.	

SNMP

Note: This menu appears only in network printers or printers that are attached to print servers.

Menu item	Description
SNMP Versions 1 and 2c Enabled Off On* Allow SNMP Set Off On* Enable PPM MIB Off On* SNMP Community	Configure Simple Network Management Protocol (SNMP) versions 1 and 2c to install print drivers and applications.
SNMP Version 3 Enabled Off On* Set Read/Write Credentials User Name Password Set Read-only Credentials User Name Password Authentication Hash MD5 SHA1* Minimum Authentication Level No Authentication, No Privacy Authentication, No Privacy Authentication, Privacy* Privacy Algorithm DES AES-128*	Configure SNMP version 3 to install and update printer security.
Note: An asterisk (*) next to a value indicates the factory default setting.	

IPSec

Note: This menu appears only in network printers or printers that are attached to print servers.

Menu item	Description
Enable IPSec Off* On	Enable Internet Protocol Security (IPSec).
Note: An asterisk (*) next to a value indicates the factory default setting.	

Menu item	Description
Base Configuration Default* Compatibility Secure	Set the IPSec base configuration. Note: This menu item appears only when Enable IPSec is set to On.
IPSec Device Certificate	Specify an IPSec certificate. Note: This menu item appears only when Base Configuration is set to Compatibility.
Pre-Shared Key Authenticated Connections Host [x] Address Key	Configure the authenticated connections of the printer. Note: These menu items appear only when Enable IPSec is set to On.
Certificate Authenticated Connections Host [x] Address[/subnet] Address[/subnet]	
Note: An asterisk (*) next to a value indicates the factory default setting.	

802.1x

Note: This menu appears only in network printers or printers that are attached to print servers.

Menu item	Description
Active Off* On	Let the printer join networks that require authentication before allowing access. Note: To configure the settings of this menu item, access the Embedded Web Server.
Note: An asterisk (*) next to a value indicates the factory default setting.	

LPD Configuration

Note: This menu appears only in network printers or printers that are attached to print servers.

Menu item	Description
LPD Timeout 0–65535 seconds (90*)	Set the time-out value to stop the Line Printer Daemon (LPD) server from waiting indefinitely for hung or invalid print jobs.
LPD Banner Page Off* On	Print a banner page for all LPD print jobs. Note: A banner page is the first page of a print job used as a separator of print jobs and to identify the originator of the print job request.
Note: An asterisk (*) next to a value indicates the factory default setting.	

Menu item	Description
LPD Trailer Page Off* On	Print a trailer page for all LPD print jobs. Note: A trailer page is the last page of a print job.
LPD Carriage Return Conversion Off* On	Enable carriage return conversion. Note: Carriage return is a mechanism that commands the printer to move the position of the cursor to the first position on the same line.
Note: An asterisk (*) next to a value indicates the factory default setting.	

HTTP/FTP Settings

Note: This menu appears only in network printers or printers attached to print servers.

Menu item	Description
Enable HTTP Server Off On*	Access the Embedded Web Server to monitor and manage the printer.
Enable HTTPS Off On*	Configure the Hypertext Transfer Protocol Secure (HTTPS) settings.
Enable FTP/TFTP Off On*	Send files using FTP.
Local Domains	Specify domain names for HTTP and FTP servers. Note: This menu item appears only in some printer models.
HTTP Proxy IP Address	Configure the HTTP and FTP server settings. Note: These menu items appear only in some printer models.
FTP Proxy IP Address	
HTTP Default IP Port 1–65535 (80*)	
HTTPS Device Certificate	
FTP Default IP Port 1–65535 (21*)	
Timeout for HTTP/FTP Requests 1–299 (30*)	Specify the amount of time before the server connection stops.
Retries for HTTP/FTP Requests 1–299 (3*)	Set the number of retries to connect to the HTTP/FTP server.
Note: An asterisk (*) next to a value indicates the factory default setting.	

ThinPrint

Menu item	Description
Enable ThinPrint Off On*	Print using ThinPrint.
Port Number 4000–4999 (4000*)	Set the port number for the ThinPrint server.
Bandwidth (bits/sec) 0* 100–1000000	Set the speed to transmit data in a ThinPrint environment.
Packet Size (kbytes) 0–64000 (0*)	Set the packet size for data transmission.
Note: An asterisk (*) next to a value indicates the factory default setting.	

USB

Menu item	Description
PCL SmartSwitch On* Off	Set the printer to switch to PCL emulation when a print job received through a USB port requires it, regardless of the default printer language. Note: If PCL SmartSwitch is off, then the printer does not examine incoming data and uses the default printer language specified in the Setup menu.
PS SmartSwitch On* Off	Set the printer to switch to PS emulation when a print job received through a USB port requires it, regardless of the default printer language. Note: If PS SmartSwitch is off, then the printer does not examine incoming data and uses the default printer language specified in the Setup menu.
Mac Binary PS Auto* On Off	Set the printer to process Macintosh binary PostScript print jobs. Notes: <ul style="list-style-type: none"> • On processes raw binary PostScript print jobs. • Off filters print jobs using the standard protocol.
Enable USB Port Enable* Disable	Enable the standard USB port.
Note: An asterisk (*) next to a value indicates the factory default setting.	

Google Cloud Print

Menu item	Description
Registration Register	Register the printer to the Google Cloud Print server.
Note: An asterisk (*) next to a value indicates the factory default setting.	

Menu item	Description
Options Enable Google Cloud Print Off On*	Print directly from your Google account.
Options Enable Local Discovery Off On*	Allow the registered user and other users on the same subnet to send jobs to the printer locally.
Options Enable SSL Peer Verification Off On*	Verify authenticity of the peer certificate to connect to your Google account.
Options Always Print As Image Off* On	Set the printer to process PDF files as an image for faster printing.
Note: An asterisk (*) next to a value indicates the factory default setting.	

Wi-Fi Direct

Note: This menu appears only when a direct Wi-Fi network is the active network.

Menu item	Description
SSID	Specify the service set identifier (SSID) of the Wi-Fi network.
Set Preshared Key	Set the preshared key (PSK) to authenticate and validate users on a Wi-Fi connection.
Show PSK on Setup Page Off On*	Show the PSK on the Network Setup Page.
Group Owner IP Address	Specify the IP address of the group owner.
Auto-Accept Push Button Requests Off* On	Accept requests to connect to the network automatically. Note: Accepting clients automatically is not secured.
Note: An asterisk (*) next to a value indicates the factory default setting.	

Security

Security Audit Log

Menu item	Description
Enable Audit Off* On	Record the events in the secure audit log and remote syslog.
Enable Remote Syslog Off* On	Send audit logs to a remote server.
Remote Syslog Server	Specify the remote syslog server.
Remote Syslog Port 1–65535 (514*)	Specify the remote syslog port.
Remote Syslog Method Normal UDP* Stunnel	Specify a syslog method to transmit logged events to a remote server.
Note: An asterisk (*) next to a value indicates the factory default setting.	

Menu item	Description
<p>Remote Syslog Facility</p> <ul style="list-style-type: none"> 0 - Kernel Messages 1 - User-Level Messages 2 - Mail System 3 - System Daemons 4 - Security/Authorization Messages* 5 - Messages Generated Internally by Syslogs 6 - Line Printer Subsystem 7 - Network News Subsystem 8 - UUCP Subsystem 9 - Clock Daemon 10 - Security/Authorization Messages 11 - FTP Daemon 12 - NTP Subsystem 13 - Log Audit 14 - Log Alert 15 - Clock Daemon 16 - Local Use 0 (local0) 17 - Local Use 1 (local1) 18 - Local Use 2 (local2) 19 - Local Use 3 (local3) 20 - Local Use 4 (local4) 21 - Local Use 5 (local5) 22 - Local Use 6 (local6) 23 - Local Use 7 (local7) 	<p>Specify a facility code that the printer uses when sending log events to a remote server.</p>
<p>Severity of Events to Log</p> <ul style="list-style-type: none"> 0 - Emergency 1 - Alert 2 - Critical 3 - Error 4 - Warning* 5 - Notice 6 - Informational 7 - Debug 	<p>Specify the priority level cutoff for logging messages and events.</p>
<p>Remote Syslog Non-Logged Events</p> <ul style="list-style-type: none"> Off* On 	<p>Send all events, regardless of severity level, to the remote server.</p>
<p>Admin's E-mail Address</p>	<p>Send e-mail notification of logged events to the administrator.</p>
<p>Note: An asterisk (*) next to a value indicates the factory default setting.</p>	

Menu item	Description
E-mail Log Cleared Alert Off* On	Send e-mail notification to the administrator when a log entry is deleted.
E-mail Log Wrapped Alert Off* On	Send e-mail notification to the administrator when the log becomes full and begins to overwrite the oldest entries.
Log Full Behavior Wrap Over Older Entries* E-mail Log Then Delete All Entries	Resolve log storage issues when the log fills its allotted memory.
E-mail % Full Alert Off* On	Send e-mail notification to the administrator when the log fills its allotted memory.
% Full Alert Level 1–99 (90*)	
E-mail Log Exported Alert Off* On	Send e-mail notification to the administrator when a log is exported.
E-mail Log Settings Changed Alert Off* On	Send e-mail notification to the administrator when Enable Audit is set.
Log Line Endings LF (\n)* CR (\r) CRLF (\r\n)	Specify how the log file terminates the end of each line.
Digitally Sign Exports Off* On	Add a digital signature to each exported log file.
Clear Log	Delete all audit logs.
Export Log Syslog (RFC 5424) Syslog (RFC 3164) CSV	Export a security log to a flash drive.
Note: An asterisk (*) next to a value indicates the factory default setting.	

Login Restrictions

Menu item	Description
Login failures 1–10 (3*)	Specify the number of failed login attempts before the user gets locked out.
Failure time frame 1–60 minutes (5*)	Specify the time frame between failed login attempts before the user gets locked out.
Lockout time 1–60 minutes (5*)	Specify the lockout duration.
Web Login Timeout 1–120 minutes (10*)	Specify the delay for a remote login before the user is logged off automatically.
Note: An asterisk (*) next to a value indicates the factory default setting.	

Confidential Print Setup

Menu item	Description
Max Invalid PIN 2–10	Set the number of times an invalid PIN can be entered. Notes: <ul style="list-style-type: none"> • A value of zero turns off this setting. • When the limit is reached, the print jobs for that user name and PIN are deleted. • This menu item appears only when a hard disk is installed.
Confidential Job Expiration Off* 1 Hour 4 Hours 24 Hours 1 Week	Set the expiration time for confidential print jobs. Notes: <ul style="list-style-type: none"> • If this menu item is changed while confidential print jobs reside in the printer memory or hard disk, then the expiration time for those print jobs does not change to the new default value. • If the printer is turned off, then all confidential jobs held in the printer memory are deleted.
Repeat Job Expiration Off* 1 Hour 4 Hours 24 Hours 1 Week	Set the expiration time for a print job that you want to repeat.
Verify Job Expiration Off* 1 Hour 4 Hours 24 Hours 1 Week	Set the expiration time that the printer prints a copy for the user to examine its quality, before printing the remaining copies.
Note: An asterisk (*) next to a value indicates the factory default setting.	

Menu item	Description
Reserve Job Expiration Off* 1 Hour 4 Hours 24 Hours 1 Week	Set the expiration time that the printer stores print jobs for printing at a later time.
Require All Jobs to be Held Off* On	Set the printer to hold all print jobs.
Note: An asterisk (*) next to a value indicates the factory default setting.	

Solutions LDAP Settings

Use	To
Follow LDAP Referrals Off* On	Search the different servers in the domain for the logged-in user account.
LDAP Certificate Verification No* Yes	Enable verification of LDAP certificates.

Mobile Services Management

Use	To
AirPrint Print Scan Fax	Enable functions in the AirPrint software feature.

Miscellaneous

Menu item	Description
Print Permission On Off*	Allow users to print.
Note: An asterisk (*) next to a value indicates the factory default setting.	

Menu item	Description
Security Reset Jumper Enable “Guest” access* No Effect	Specify the effect of using the security reset jumper. Notes: <ul style="list-style-type: none"> • The jumper is located beside a lock icon on the controller board. • Enable “Guest” access provides guests with full access control. • No Effect means that the reset has no effect on the printer security configuration.
Minimum Password Length 0–32 (0*)	Specify the minimum characters allowed for a password.
Note: An asterisk (*) next to a value indicates the factory default setting.	

Reports

Menu Settings Page

Menu item	Description
Menu Settings Page	Print a report that contains the printer preferences, settings, and configurations.

Device

Menu item	Description
Device Information	Print a report that contains information about the printer.
Device Statistics	Print a report about printer usage and supply status.
Profile List	Print a list of profiles that are stored in the printer.
Asset Report	Print a report that contains the printer serial number and model name.

Print

Menu item	Description
Print Fonts PCL Fonts PostScript Fonts	Print samples and information about the fonts that are available in each printer language.
Print Demo Demo Page	Print a page that shows the printer capabilities and supported solutions.

Shortcuts

Menu item	Description
All Shortcuts	Print a report that lists the shortcuts that are stored in the printer.
Fax Shortcuts	
Copy Shortcuts	
E-mail Shortcuts	
FTP Shortcuts	
Network Folder Shortcuts	

Fax

Menu item	Description
Fax Job Log	Print a report about the last 200 completed fax jobs. Note: This menu item appears only when Enable Job Log is set to On.
Fax Call Log	Print a report about the last 100 attempted, received, and blocked calls. Note: This menu item appears only when Enable Job Log is set to On.

Network

Menu item	Description
Network Setup Page	Print a page that shows the configured network and wireless settings on the printer. Note: This menu item appears only in network printers or printers connected to print servers.

Help

Menu item	Description
Print All Guides	Prints all the guides
Connection Guide	Provides information about connecting the printer locally (USB) or to a network
Copy Guide	Provides information about making copies and configuring the settings
E-mail Guide	Provides information about sending e-mails and configuring the settings
Fax Guide	Provides information about sending faxes and configuring the settings
FTP Guide	Provides information about scanning documents and configuring the settings
Information Guide	Provides more information sources about the printer
Media Guide	Provides information about loading paper and specialty media
Mono Quality Guide	Provides information about mono print quality settings

Menu item	Description
Moving Guide	Provides information about moving, locating, or shipping the printer
Print Quality Guide	Provides information about solving print quality issues
Supplies Guide	Provides information about ordering supplies

Troubleshooting

Menu item	Description
Print Quality Test Pages	Print sample pages to identify and correct print quality defects.
Cleaning the Scanner	Print instructions on how to clean the scanner.

Printing the Menu Settings Page

1 From the control panel, navigate to:

 > **Settings** >  > **Reports** > 

2 Select **Menu Settings Page**, and then press .

Securing the printer

Locating the security slot

The printer is equipped with a security lock feature. Attach a security lock compatible with most laptop computers in the location shown to secure the printer in place.



Erasing printer memory

To erase volatile memory or buffered data, turn off the printer.

To erase non-volatile memory or individual settings, device and network settings, security settings, and embedded solutions, do the following:

- 1 From the control panel, navigate to:

 > **Settings** >  > **Device** >  > **Maintenance** >  > **Out of Service Erase** > 

- 2 Select **Sanitize all information on nonvolatile memory**, and then press .

- 3 To start the job, select **Continue**, and then press .

- 4 Follow the instructions on the display.

Restoring factory default settings

1 From the control panel, navigate to:

 > **Settings** >  > **Device** >  > **Restore Factory Defaults** >  > **Restore Settings** > 

2 Select **Restore all settings**, and then press .

3 Select **RESTORE**, and then press .

For a more comprehensive method of restoring the factory default settings, see [“Erasing printer memory” on page 118](#).

Statement of Volatility

Your printer contains various types of memory that can store device and network settings, and user data.

Type of memory	Description
Volatile memory	Your printer uses standard <i>random access memory</i> (RAM) to temporarily buffer user data during simple print jobs.
Non-volatile memory	Your printer may use two forms of non-volatile memory: EEPROM and NAND (flash memory). Both types are used to store operating system, device settings, and network information.

Erase the content of any installed printer memory in the following circumstances:

- The printer is being decommissioned.
- The printer is being moved to a different department or location.
- The printer is being serviced by someone from outside your organization.
- The printer is being removed from your premises for service.
- The printer is being sold to another organization.

Maintaining the printer

Warning—Potential Damage: Failure to maintain optimum printer performance, or to replace parts and supplies, may cause damage to your printer.

Networking

Connecting the printer to a Wi-Fi network

Make sure that Active Adapter is set to Auto. From the control panel, navigate to:

Settings > **OK** > **Network/Ports** > **OK** > **Network Overview** > **OK** > **Active Adapter** > **OK** > **Auto** > **OK**

Using the control panel

- 1 From the control panel, navigate to:

Settings > **OK** > **Network/Ports** > **OK** > **Wireless** > **OK** > **Setup On Printer Panel** > **OK** > **Choose Network**
> **OK**

- 2 Select a Wi-Fi network, and then type the network password.

Note: For Wi-Fi-network-ready printer models, a prompt for Wi-Fi network setup appears during initial setup.

Using Lexmark Mobile Assistant

- 1 Depending on your mobile device, download the Lexmark Mobile Assistant application from either the Google Play store or App Store online store.
- 2 From the printer control panel, navigate to:

Settings > **OK** > **Network/Ports** > **OK** > **Wireless** > **OK** > **Setup Using Mobile App** > **OK** > **Printer ID** >
OK

- 3 From your mobile device, launch the application, and then accept the Terms of Use.

Note: If necessary, grant permissions.

- 4 Tap **Connect to Printer** > **Go to Wi-Fi Settings**.
- 5 Connect your mobile device to the printer wireless network.
- 6 Return to the application, and then tap **Setup Wi-Fi Connection**
- 7 Select a Wi-Fi network, and then type the network password.
- 8 Tap **Done**.

Connecting the printer to a wireless network using Wi-Fi Protected Setup (WPS)

Before you begin, make sure that:

- The access point (wireless router) is WPS-certified or WPS-compatible. For more information, see the documentation that came with your access point.
- A wireless network adapter is installed in your printer. For more information, see the instructions that came with the adapter.
- Make sure that Active Adapter is set to Auto. From the control panel, navigate to:

 > **Settings** >  > **Network/Ports** >  > **Network Overview** >  > **Active Adapter** >  > **Auto** > 

Using the Push Button method

- 1 From the control panel, navigate to:

 > **Settings** >  > **Network/Ports** >  > **Wireless** >  > **Wi-Fi Protected Setup** >  > **Start Push Button Method** > 

- 2 Follow the instructions on the display.

Using the personal identification number (PIN) method

- 1 From the control panel, navigate to:

 > **Settings** >  > **Network/Ports** >  > **Wireless** >  > **Wi-Fi Protected Setup** >  > **Start PIN Method** > 

- 2 Copy the eight-digit WPS PIN.
- 3 Open a web browser, and then type the IP address of your access point in the address field.

Notes:

- To know the IP address, see the documentation that came with your access point.
 - If you are using a proxy server, then temporarily disable it to load the web page correctly.
- 4 Access the WPS settings. For more information, see the documentation that came with your access point.
 - 5 Enter the eight-digit PIN, and then save the changes.

Configuring Wi-Fi Direct

Note: This feature is available only in some printer models.

Wi-Fi Direct® is a Wi-Fi-based peer-to-peer technology that allows wireless devices to connect directly to a Wi-Fi Direct-enabled printer without using an access point (wireless router).

1 From the control panel, navigate to:

Settings >  > **Network/Ports** >  > **Wi-Fi Direct** > 

2 Configure the settings.

- **Enable Wi-Fi Direct**—Enables the printer to broadcast its own Wi-Fi Direct network.
- **Wi-Fi Direct Name**—Assigns a name for the Wi-Fi Direct network.
- **Wi-Fi Direct Password**—Assigns the password for negotiating the wireless security when using the peer-to-peer connection.
- **Show Password on Setup Page**—Shows the password on the Network Setup Page.
- **Auto-Accept Push Button Requests**—Lets the printer accept connection requests automatically.

Note: Accepting push-button requests automatically is not secured.

Connecting a mobile device to the printer

Before connecting your mobile device, make sure that Wi-Fi Direct has been configured. For more information, see [“Configuring Wi-Fi Direct” on page 122](#).

Connecting using Wi-Fi Direct

Note: These instructions apply only to Android mobile devices.

- 1 From the mobile device, go to the settings menu.
- 2 Enable **Wi-Fi**, and then tap **Wi-Fi Direct**.
- 3 Select the printer Wi-Fi Direct name.
- 4 Confirm the connection on the printer control panel.

Connecting using Wi-Fi

- 1 From the mobile device, go to the settings menu.
- 2 Tap **Wi-Fi**, and then select the printer Wi-Fi Direct name.

Note: The string DIRECT-xy (where x and y are two random characters) is added before the Wi-Fi Direct name.

- 3 Enter the Wi-Fi Direct password.

Connecting a computer to the printer

Before connecting your computer, make sure that Wi-Fi Direct has been configured. For more information, see [“Configuring Wi-Fi Direct” on page 122](#).

For Windows users

- 1 Open **Printers & scanners**, and then click **Add a printer or scanner**.
- 2 Click **Show Wi-Fi Direct printers**, and then select the printer Wi-Fi Direct name.
- 3 From the printer display, take note of the eight-digit PIN of the printer.
- 4 Enter the PIN on the computer.

Note: If the print driver is not already installed, then Windows downloads the appropriate driver.

For Macintosh users

- 1 Click the wireless icon, and then select the printer Wi-Fi Direct name.

Note: The string DIRECT-xy (where x and y are two random characters) is added before the Wi-Fi Direct name.

- 2 Type the Wi-Fi Direct password.

Note: Switch your computer back to its previous network after disconnecting from the Wi-Fi Direct network.

Deactivating the Wi-Fi network

- 1 From the printer control panel, navigate to:

 > **Settings** >  > **Network/Ports** >  > **Network Overview** >  > **Active Adapter** >  > **Standard Network** > 

- 2 Follow the instructions on the display.

Cleaning printer parts

Cleaning the printer

 **CAUTION—SHOCK HAZARD:** To avoid the risk of electrical shock when cleaning the exterior of the printer, unplug the power cord from the electrical outlet and disconnect all cables from the printer before proceeding.

Notes:

- Perform this task after every few months.
- Damage to the printer caused by improper handling is not covered by the printer warranty.

- 1 Turn off the printer, and then unplug the power cord from the electrical outlet.
- 2 Remove paper from the standard bin and multipurpose feeder.
- 3 Remove any dust, lint, and pieces of paper around the printer using a soft brush or vacuum.

4 Wipe the outside of the printer with a damp, soft, lint-free cloth.

Notes:

- Do not use household cleaners or detergents, as they may damage the finish of the printer.
- Make sure that all areas of the printer are dry after cleaning.

5 Connect the power cord to the electrical outlet, and then turn on the printer.

 **CAUTION—POTENTIAL INJURY:** To avoid the risk of fire or electrical shock, connect the power cord to an appropriately rated and properly grounded electrical outlet that is near the product and easily accessible.

Cleaning the scanner

1 Open the scanner cover.



2 Using a damp, soft, lint-free cloth, wipe the following areas:

- ADF glass



- ADF glass pad



- Scanner glass



- Scanner glass pad



3 Close the scanner cover.

Ordering parts and supplies

To order parts and supplies in the U.S., contact 1-800-539-6275 for information about Lexmark authorized dealers in your area. In other countries or regions, go to www.lexmark.com or contact the place where you purchased the printer.

Note: All life estimates for printer supplies assume printing on letter- or A4-size plain paper.

Checking the status of parts and supplies

From the control panel, navigate to:

 > **Status/Supplies** >  > **Supplies** > 

Using genuine Lexmark parts and supplies

Your Lexmark printer is designed to function best with genuine Lexmark parts and supplies. Use of third-party supplies or parts may affect the performance, reliability, or life of the printer and its imaging components. It can also affect warranty coverage. Damage caused by the use of third-party parts and supplies is not covered by the warranty. All life indicators are designed to function with Lexmark parts and supplies, and may deliver unpredictable results if third-party parts and supplies are used. Imaging component usage beyond the intended life may damage your Lexmark printer or its associated components.

Warning—Potential Damage: Supplies and parts without Return Program agreement terms may be reset and remanufactured. However, the manufacturer’s warranty does not cover any damage caused by non-genuine supplies or parts. Resetting counters on the supply or part without proper remanufacturing can cause damage to your printer. After resetting the supply or part counter, your printer may display an error indicating the presence of the reset item.

Ordering a toner cartridge

Notes:

- The estimated cartridge yield is based on the ISO/IEC 19752 standard.
- Extremely low print coverage for extended periods of time may negatively affect actual yield.

Lexmark MX321 Return Program toner cartridges

Item	United States and Canada	European Economic Area	Rest of Asia Pacific	Latin America	Rest of Europe, Middle East, and Africa	Australia and New Zealand
Return Program toner cartridge	56F1000	56F2000	56F3000	56F4000	56F5000	56F6000
High yield Return Program toner cartridge	56F1H00	56F2H00	56F3H00	56F4H00	56F5H00	56F6H00
High yield Corporate Return Program toner cartridge*	56F1H0E	56F2H0E	56F3H0E	56F4H0E	56F5H0E	56F6H0E

* Available only for contract-managed printers. For more information, contact your Lexmark representative or system administrator.

Lexmark MX321 regular toner cartridge

Item	Worldwide
High yield regular toner cartridge	56F0HA0

Lexmark MB2338 Return Program toner cartridge

Item	United States, Canada, Australia, and New Zealand	European Economic Area	Rest of Asia Pacific	Latin America	Rest of Europe, Middle East, and Africa
Return Program toner cartridge	B231000	B232000	B233000	B234000	B235000

Lexmark MB2338 regular toner cartridge

Item	Worldwide
Regular toner cartridge	B2300A0

Ordering an imaging unit

Extremely low print coverage for extended periods of time may cause imaging unit parts to fail before the toner is exhausted.

Item	Part Number
Return Program imaging unit	56F0Z00
Regular imaging unit	56F0ZA0
Corporate Return Program imaging unit*	56F0Z0E

* This imaging unit is available only for contract-managed printers. For more information, contact your Lexmark representative or system administrator.

Configuring supply notifications

- 1 Open a web browser, and then type the printer IP address in the address field.

Notes:

- View the printer IP address on the printer home screen. The IP address appears as four sets of numbers separated by periods, such as 123.123.123.123.
- If you are using a proxy server, then temporarily disable it to load the web page correctly.

- 2 Click **Settings > Device > Notifications**.
- 3 From the Supplies menu, click **Custom Supply Notifications**.
- 4 Select a notification for each supply item.
- 5 Apply the changes.

Replacing parts and supplies

Replacing the toner cartridge

- 1 Open door A.

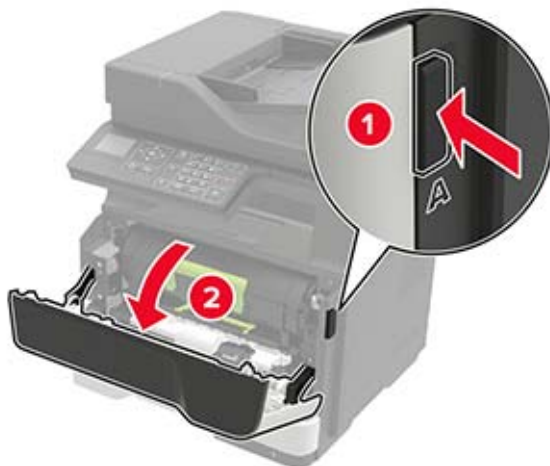

- 2 Remove the used toner cartridge.



- 3 Unpack the new toner cartridge, and then shake it three times to redistribute the toner.



- 4 Insert the new toner cartridge.

Note: Use the arrows inside the printer as guides.



- 5 Close door A.

Replacing the imaging unit

1 Open door A.

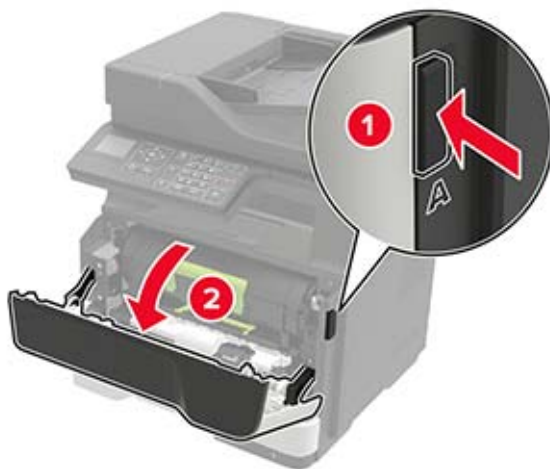

2 Remove the toner cartridge.



3 Remove the used imaging unit.



- 4 Unpack the new imaging unit, and then shake it three times to redistribute the toner.



Warning—Potential Damage: Do not expose the imaging unit to direct light for more than 10 minutes. Extended exposure to light may cause print quality problems.

Warning—Potential Damage: Do not touch the photoconductor drum. Doing so may affect the quality of future print jobs.



- 5 Insert the new imaging unit.

Note: Use the arrows inside the printer as guides.



- 6 Insert the toner cartridge.

Note: Use the arrows inside the printer as guides.



7 Close door A.

Replacing the pick tires

- 1** Turn off the printer.
- 2** Unplug the power cord from the electrical outlet, and then from the printer.
- 3** Remove the tray.



4 Remove the used pick tires one after the other.

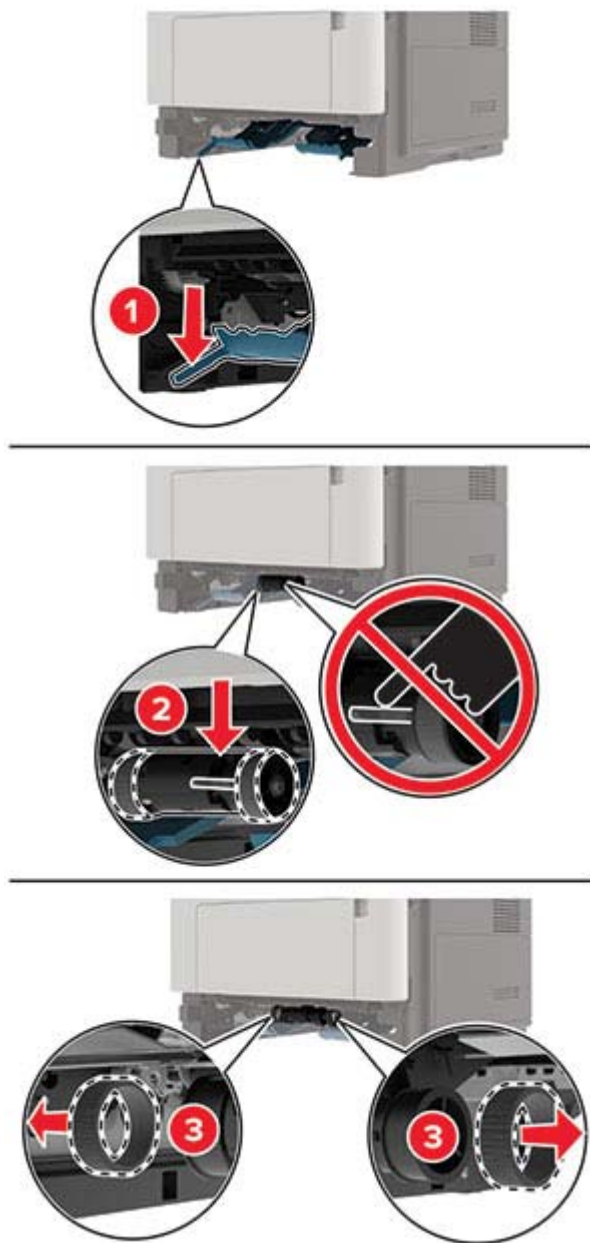

5 Unpack the new pick tires.

- 6 Insert the new pick tires.

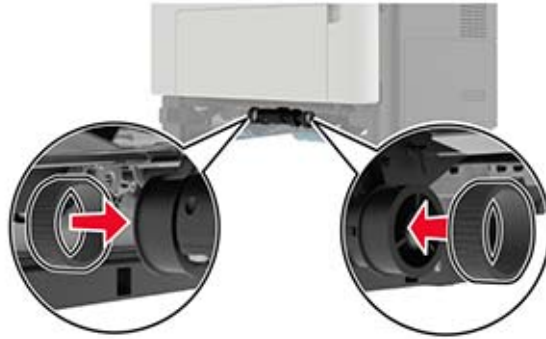

- 7 Insert the tray.
- 8 Connect the power cord to the printer, and then to the electrical outlet.

⚠ CAUTION—POTENTIAL INJURY: To avoid the risk of fire or electrical shock, connect the power cord to an appropriately rated and properly grounded electrical outlet that is near the product and easily accessible.

- 9 Turn on the printer.

Replacing the pick roller assembly

- 1 Turn off the printer.
- 2 Unplug the power cord from the electrical outlet, and then from the printer.
- 3 Remove the optional tray.

⚠ CAUTION—POTENTIAL INJURY: If the printer weight is greater than 20 kg (44 lb), then it may require two or more people to lift it safely.



4 Remove the tray insert, and then flip the tray base.

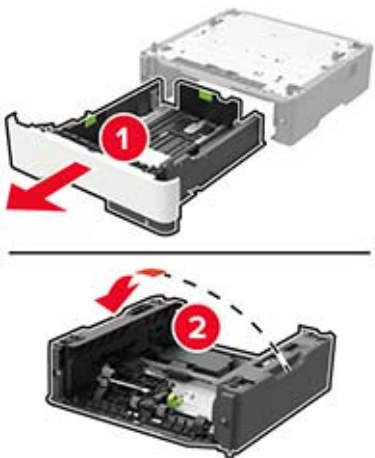

5 Remove the used pick roller assembly.

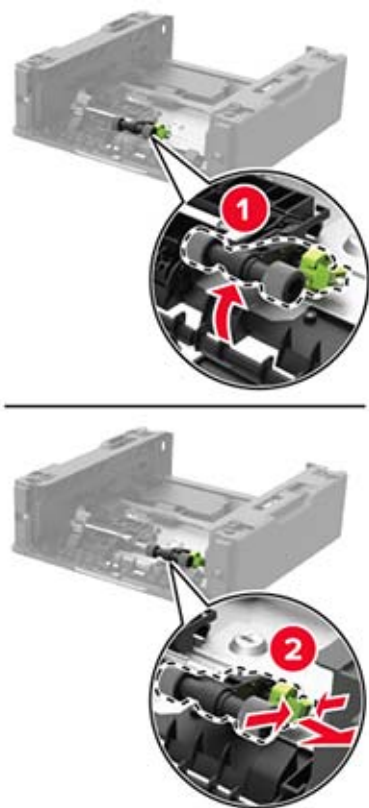

6 Unpack the new pick roller assembly.

7 Insert the new pick roller assembly.

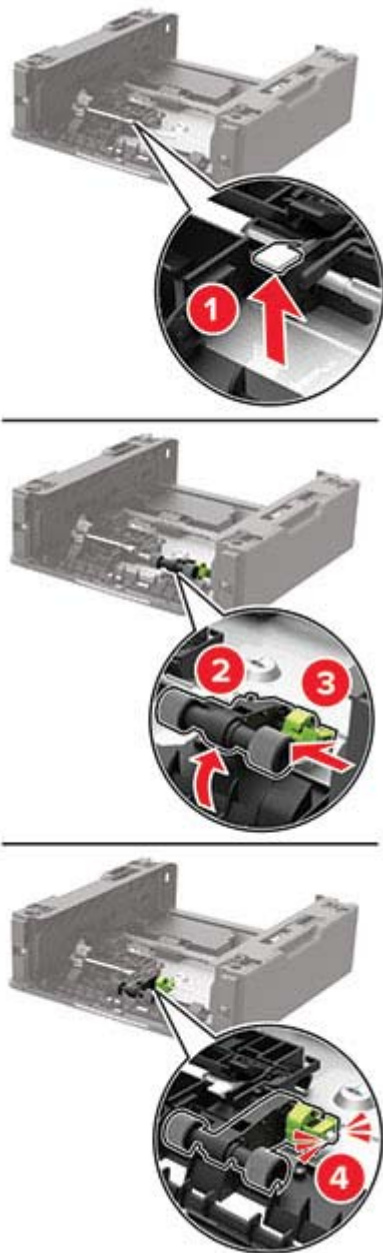

8 Flip the tray base, and then insert the tray insert.

- 9 Align the printer with the optional tray, and then lower the printer until it *clicks* into place.



- 10 Connect the power cord to the printer, and then to the electrical outlet.

 **CAUTION—POTENTIAL INJURY:** To avoid the risk of fire or electrical shock, connect the power cord to an appropriately rated and properly grounded electrical outlet that is near the product and easily accessible.

- 11 Turn on the printer.

Replacing the ADF separator roller

- 1 Open the ADF cover.



- 2 Remove the used ADF separator roller.

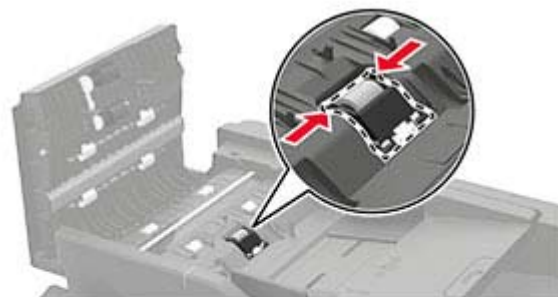

- 3 Unpack the new ADF separator roller.

Warning—Potential Damage: To avoid damage and poor printer performance, handle this part with clean hands.

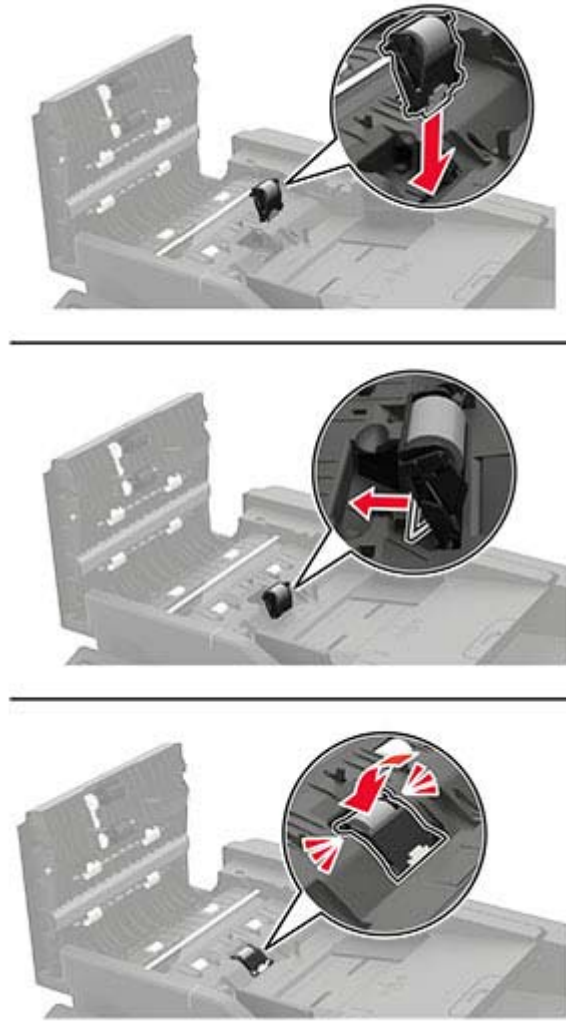

- 4 Insert the new ADF separator roller until it *clicks* into place.



- 5 Close the ADF cover.

Moving the printer

Moving the printer to another location

-  **CAUTION—POTENTIAL INJURY:** If the printer weight is greater than 20 kg (44 lb), then it may require two or more people to lift it safely.
-  **CAUTION—POTENTIAL INJURY:** To avoid the risk of fire or electrical shock, use only the power cord provided with this product or the manufacturer's authorized replacement.
-  **CAUTION—POTENTIAL INJURY:** When moving the printer, follow these guidelines to avoid personal injury or printer damage:
 - Make sure that all doors and trays are closed.
 - Turn off the printer, and then unplug the power cord from the electrical outlet.

- Disconnect all cords and cables from the printer.
- If the printer has separate floor-standing optional trays or output options attached to it, then disconnect them before moving the printer.
- If the printer has a caster base, then carefully roll it to the new location. Use caution when passing over thresholds and breaks in flooring.
- If the printer does not have a caster base but is configured with optional trays or output options, then remove the output options and lift the printer off the trays. Do not try to lift the printer and any options at the same time.
- Always use the handholds on the printer to lift it.
- Any cart used to move the printer must have a surface able to support the full footprint of the printer.
- Any cart used to move the hardware options must have a surface able to support the dimensions of the options.
- Keep the printer in an upright position.
- Avoid severe jarring movements.
- Make sure that your fingers are not under the printer when you set it down.
- Make sure that there is adequate clearance around the printer.

Note: Damage to the printer caused by improper moving is not covered by the printer warranty.

Shipping the printer

For shipping instructions, go to <http://support.lexmark.com> or contact customer support.

Saving energy and paper

Configuring the power save mode settings

Sleep mode

- 1 From the control panel, navigate to:

Settings > **OK** > **Device** > **OK** > **Power Management** > **OK** > **Timeouts** > **OK** > **Sleep Mode** > **OK**

- 2 Enter the amount of time that the printer stays idle before it enters Sleep mode.

Hibernate mode

- 1 From the control panel, navigate to:

Settings > **OK** > **Device** > **OK** > **Power Management** > **OK** > **Timeouts** > **OK** > **Hibernate Timeout** > **OK**

- 2 Select the amount of time before the printer enters Hibernate mode.

Notes:

- Make sure to wake the printer from Hibernate mode before sending a print job.
- To wake the printer from Hibernate mode, press the power button.

- The Embedded Web Server is disabled when the printer is in Hibernate mode.

Conserving supplies

- Print on both sides of the paper.
Note: Two-sided printing is the default setting in the print driver.
- Print multiple pages on a single sheet of paper.
- Use the preview feature to see how the document looks like before printing it.
- Print one copy of the document to check its content and format for accuracy.

Recycling

Recycling Lexmark products

To return Lexmark products for recycling:

- 1 Go to www.lexmark.com/recycle.
- 2 Select the product you want to recycle.

Note: Printer supplies and hardware not listed in the Lexmark Collection and Recycling Program may be recycled through your local recycling center.

Recycling Lexmark packaging

Lexmark continually strives to minimize packaging. Less packaging helps to ensure that Lexmark printers are transported in the most efficient and environmentally sensitive manner and that there is less packaging to dispose of. These efficiencies result in fewer greenhouse emissions, energy savings, and natural resource savings. Lexmark also offers recycling of packaging components in some countries or regions. For more information, go to www.lexmark.com/recycle, and then choose your country or region. Information on available packaging recycling programs is included with the information on product recycling.

Lexmark cartons are 100% recyclable where corrugated recycling facilities exist. Facilities may not exist in your area.

The foam used in Lexmark packaging is recyclable where foam recycling facilities exist. Facilities may not exist in your area.

When you return a cartridge to Lexmark, you can reuse the box that the cartridge came in. Lexmark recycles the box.

Clearing jams

Avoiding jams

Load paper properly

- Make sure that the paper lies flat in the tray.

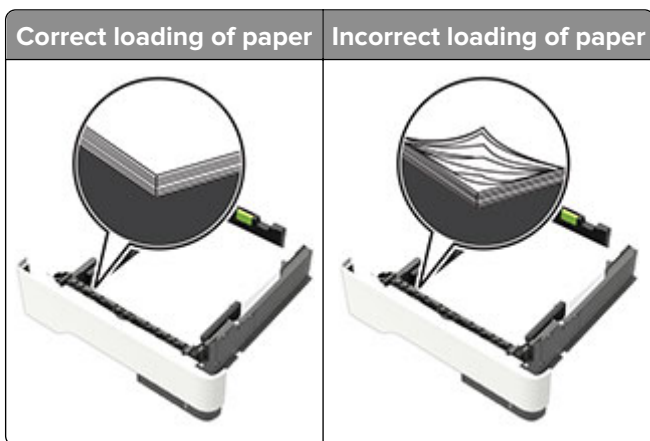

- Do not load or remove a tray while the printer is printing.
- Do not load too much paper. Make sure that the stack height is below the maximum paper fill indicator.
- Do not slide paper into the tray. Load paper as shown in the illustration.

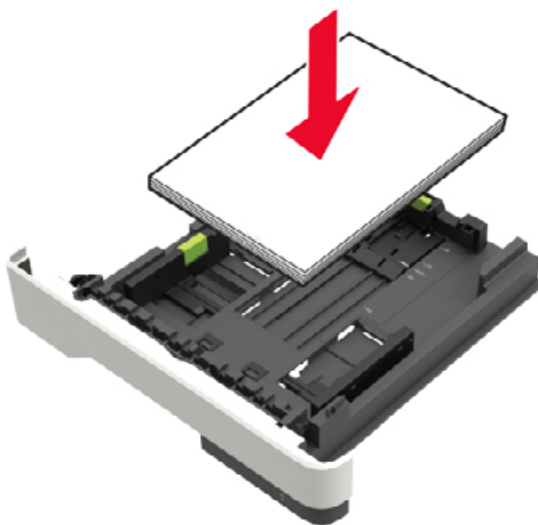

- Make sure that the paper guides are positioned correctly and are not pressing tightly against the paper or envelopes.
- Push the tray firmly into the printer after loading paper.

Use recommended paper

- Use only recommended paper or specialty media.
- Do not load paper that is wrinkled, creased, damp, bent, or curled.

- Flex, fan, and align the paper edges before loading.



- Do not use paper that has been cut or trimmed by hand.
- Do not mix paper sizes, weights, or types in the same tray.
- Make sure that the paper size and type are set correctly on the computer or printer control panel.
- Store paper according to manufacturer recommendations.

Identifying jam locations

Notes:

- When Jam Assist is set to On, the printer automatically flushes blank pages or partially printed pages with after a jammed page is cleared. Check your printed output for blank pages.
- When Jam Recovery is set to On or Auto, the printer reprints jammed pages.



	Jam location
1	Automatic document feeder
2	Standard bin
3	Rear door
4	Standard 250-sheet tray
5	Optional 250- or 550-sheet tray
6	Multipurpose feeder
7	Door A

Paper jam in door A

1 Remove the tray.



2 Open door A.

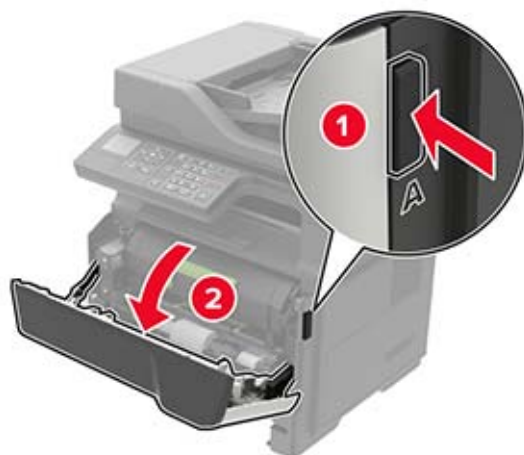

- 3 Remove the toner cartridge.



- 4 Remove the imaging unit.



Warning—Potential Damage: Do not expose the imaging unit to direct light for more than 10 minutes. Extended exposure to light may cause print quality problems.

Warning—Potential Damage: Do not touch the photoconductor drum. Doing so may affect the quality of future print jobs.



5 Remove the jammed paper.

 **CAUTION—HOT SURFACE:** The inside of the printer might be hot. To reduce the risk of injury from a hot component, allow the surface to cool before touching it.

Note: Make sure that all paper fragments are removed.

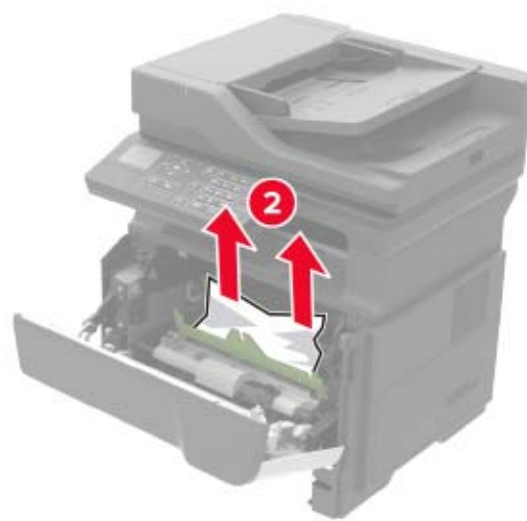

6 Insert the imaging unit.

Note: Use the arrows inside the printer as guides.



7 Insert the toner cartridge.

Note: Use the arrows inside the printer as guides.



8 Close door A.

9 Insert the tray.

Paper jam in the rear door

1 Open the rear door.

 **CAUTION—HOT SURFACE:** The inside of the printer might be hot. To reduce the risk of injury from a hot component, allow the surface to cool before touching it.



2 Remove the jammed paper.

Note: Make sure that all paper fragments are removed.



3 Close the rear door.

Paper jam in the standard bin

Remove the jammed paper.

Note: Make sure that all paper fragments are removed.



Paper jam in the duplex unit

- 1 Remove the tray.



- 2 Remove the jammed paper.

Note: Make sure that all paper fragments are removed.



- 3 Insert the tray.

Paper jam in trays

- 1 Remove the tray.



- 2 Remove the jammed paper.

Note: Make sure that all paper fragments are removed.

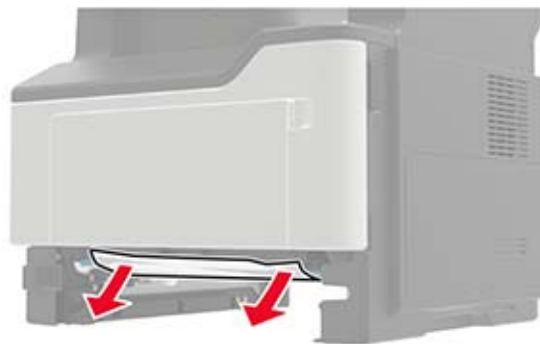

- 3 Insert the tray.

Paper jam in the multipurpose feeder

- 1 Remove paper from the multipurpose feeder.
- 2 Remove the jammed paper.

Note: Make sure that all paper fragments are removed.



3 Flex, fan, and align the paper edges before loading.



4 Reload paper, and then adjust the paper guide.



Paper jam in the automatic document feeder

- 1** Remove all original documents from the ADF tray.
- 2** Open the ADF cover.

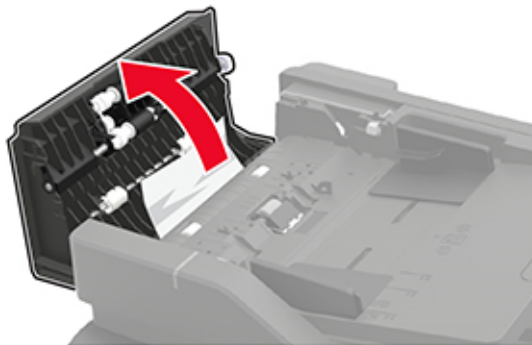

3 Remove the jammed paper.

Note: Make sure that all paper fragments are removed.

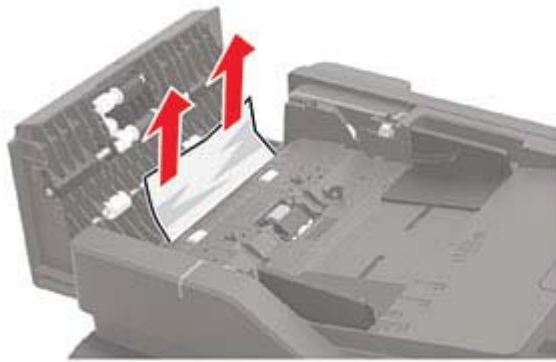

4 Close the ADF cover.

Troubleshooting

Print quality problems

Find the image that resembles the print quality problem you are having, and then click the link below it to read problem-solving steps.



[“Blank or white pages” on page 157](#)



[“Dark print” on page 158](#)



[“Fine lines are not printed correctly” on page 160](#)



[“Folded or wrinkled paper” on page 161](#)



[“Gray background” on page 162](#)



[“Horizontal light bands” on page 164](#)



[“Incorrect margins” on page 164](#)



[“Light print” on page 165](#)



[“Mottled print and dots” on page 167](#)



[“Paper curl” on page 168](#)



[“Print crooked or skewed” on page 169](#)



[“Repeating defects” on page 179](#)



[“Solid black pages” on page 170](#)



[“Text or images cut off” on page 172](#)



[“Toner easily rubs off” on page 173](#)



[“Vertical dark bands” on page 174](#)



[“Vertical dark lines or streaks” on page 176](#)

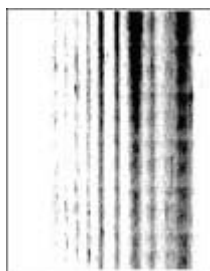

[“Vertical dark streaks with print missing” on page 177](#)



[“Vertical light bands” on page 178](#)



[“Vertical white lines” on page 178](#)

Printing problems

Print quality is poor

Blank or white pages



Note: Before solving the problem, print the Print Quality Test Pages. From the control panel, navigate to **Settings > Troubleshooting > Print Quality Test Pages**. For non-touch-screen printer models, press **OK** to navigate through the settings.

Action	Yes	No
<p>Step 1</p> <p>a Check if the printer is using a genuine and supported Lexmark toner cartridge.</p> <p>Note: If the cartridge is not supported, then install a supported one.</p> <p>b Print the document.</p> <p>Is the printer printing blank or white pages?</p>	Go to step 2.	The problem is solved.

Action	Yes	No
<p>Step 2</p> <p>a Remove any packing material that is left on the imaging unit.</p> <p>1 Remove the toner cartridge, and then remove the imaging unit.</p> <p>Warning—Potential Damage: Do not expose the imaging unit to direct light for more than 10 minutes. Extended exposure to light may cause print quality problems.</p> <p>Warning—Potential Damage: Do not touch the photoconductor drum under the imaging unit. Doing so may affect the quality of future print jobs.</p> <p>2 Check the imaging unit for signs of damage, and replace if necessary.</p> <p>Note: Make sure that the photoconductor drum contact is not bent or out of place.</p> <p>3 Firmly shake the imaging unit to redistribute the toner.</p> <p>4 Insert the imaging unit, and then insert the toner cartridge.</p> <p>b Print the document.</p> <p>Is the printer printing blank or white pages?</p>	<p>Go to step 3.</p>	<p>The problem is solved.</p>
<p>Step 3</p> <p>Check the status of the toner cartridge, and replace if necessary.</p> <p>a From the control panel, navigate to:</p> <p>Status/Supplies > Supplies</p> <p>b Print the document.</p> <p>Is the printer printing blank or white pages?</p>	<p>Contact customer support.</p>	<p>The problem is solved.</p>

Dark print



Note: Before solving the problem, print the Print Quality Test Pages. From the control panel, navigate to **Settings > Troubleshooting > Print Quality Test Pages**. For non-touch-screen printer models, press  to navigate through the settings.

Action	Yes	No
<p>Step 1</p> <p>a Check if the printer is using a genuine and supported Lexmark toner cartridge.</p> <p>Note: If the cartridge is not supported, then install a supported one.</p> <p>b Print the document.</p> <p>Is the print dark?</p>	Go to step 2.	The problem is solved.
<p>Step 2</p> <p>a Turn off the printer, wait for about 10 seconds, and then turn on the printer.</p> <p>b Reduce toner darkness. From the control panel, navigate to: Settings > Print > Quality > Toner Darkness</p> <p>c Print the document.</p> <p>Is the print dark?</p>	Go to step 3.	The problem is solved.
<p>Step 3</p> <p>a Depending on your operating system, specify the paper type from the Printing Preferences or Print dialog.</p> <p>Notes:</p> <ul style="list-style-type: none"> • Make sure that the setting matches the paper loaded. • You can also change the setting on the printer control panel. Navigate to Settings > Paper > Tray Configuration > Paper Size/Type. <p>b Print the document.</p> <p>Is the print dark?</p>	Go to step 4.	The problem is solved.
<p>Step 4</p> <p>Check if the paper has texture or rough finishes.</p> <p>Are you printing on textured or rough paper?</p>	Go to step 5.	Go to step 6.
<p>Step 5</p> <p>a Replace textured paper with plain paper.</p> <p>b Print the document.</p> <p>Is the print dark?</p>	Go to step 6.	The problem is solved.

Action	Yes	No
<p>Step 6</p> <p>a Load paper from a fresh package.</p> <p>Note: Paper absorbs moisture due to high humidity. Store paper in its original wrapper until you are ready to use it.</p> <p>b Print the document.</p> <p>Is the print dark?</p>	Go to step 7.	The problem is solved.
<p>Step 7</p> <p>a Remove, and then insert the imaging unit.</p> <p>Warning—Potential Damage: Do not expose the imaging unit to direct light for more than 10 minutes. Extended exposure to light may cause print quality problems.</p> <p>Warning—Potential Damage: Do not touch the photoconductor drum under the imaging unit. Doing so may affect the quality of future print jobs.</p> <p>b Print the document.</p> <p>Is the print dark?</p>	Go to step 8.	The problem is solved.
<p>Step 8</p> <p>a Replace the imaging unit.</p> <p>b Print the document.</p> <p>Is the print dark?</p>	Contact customer support .	The problem is solved.

Fine lines are not printed correctly



Note: Before solving the problem, print the Print Quality Test Pages. From the control panel, navigate to **Settings > Troubleshooting > Print Quality Test Pages**. For non-touch-screen printer models, press **OK** to navigate through the settings.

Action	Yes	No
<p>Step 1</p> <p>a Check if the printer is using a genuine and supported Lexmark toner cartridge.</p> <p>Note: If the cartridge is not supported, then install a supported one.</p> <p>b Print the document.</p> <p>Are fine lines not printed correctly?</p>	Go to step 2.	The problem is solved.
<p>Step 2</p> <p>a Increase toner darkness.</p> <p>From the control panel, navigate to:</p> <p>Settings > Print > Quality > Toner Darkness</p> <p>b Print the document.</p> <p>Are fine lines not printed correctly?</p>	Contact customer support .	The problem is solved.

Folded or wrinkled paper



Note: Before solving the problem, print the Print Quality Test Pages. From the control panel, navigate to **Settings > Troubleshooting > Print Quality Test Pages**. For non-touch-screen printer models, press  to navigate through the settings.

Action	Yes	No
<p>Step 1</p> <p>a Check if the printer is using a genuine and supported Lexmark toner cartridge.</p> <p>Note: If the cartridge is not supported, then install a supported one.</p> <p>b Print the document.</p> <p>Is the paper folded or wrinkled?</p>	Go to step 2.	The problem is solved.

Action	Yes	No
<p>Step 2</p> <p>a Load paper from a fresh package.</p> <p>Note: Paper absorbs moisture due to high humidity. Store paper in its original wrapper until you are ready to use it.</p> <p>b Print the document.</p> <p>Is the paper folded or wrinkled?</p>	Go to step 3.	The problem is solved.
<p>Step 3</p> <p>a Depending on your operating system, specify the paper type from the Printing Preferences or Print dialog.</p> <p>Notes:</p> <ul style="list-style-type: none"> • Make sure that the setting matches the paper loaded. • You can also change the setting from the printer control panel. Navigate to Settings > Paper > Tray Configuration > Paper Size/Type. <p>b Print the document.</p> <p>Is the paper folded or wrinkled?</p>	Contact customer support .	The problem is solved.

Gray background



Note: Before solving the problem, print the Print Quality Test Pages. From the control panel, navigate to **Settings > Troubleshooting > Print Quality Test Pages.**

Action	Yes	No
<p>Step 1</p> <p>a Turn off the printer, wait for 10 seconds, and then turn on the printer.</p> <p>b Decrease toner darkness.</p> <p>From the control panel, navigate to Settings > Print > Quality > Toner Darkness.</p> <p>c Print the document.</p> <p>Does gray background appear on prints?</p>	Go to step 2.	The problem is solved.

Action	Yes	No
<p>Step 2</p> <p>a Check if the printer is using a genuine and supported Lexmark toner cartridge.</p> <p>Note: If the cartridge is not supported, then install a supported one.</p> <p>b Print the document.</p> <p>Does gray background appear on prints?</p>	<p>Go to step 3.</p>	<p>The problem is solved.</p>
<p>Step 3</p> <p>a Depending on your operating system, specify the paper type from the Printing Preferences or Print dialog.</p> <p>Notes:</p> <ul style="list-style-type: none"> • Make sure that the setting matches the paper loaded. • You can also change the setting from the printer control panel. Navigate to Settings > Paper > Tray Configuration > Paper Size/Type. <p>b Print the document.</p> <p>Does gray background appear on prints?</p>	<p>Go to step 4.</p>	<p>The problem is solved.</p>
<p>Step 4</p> <p>a Remove, and then insert the imaging unit.</p> <p>Warning—Potential Damage: Do not expose the imaging unit to direct light. Extended exposure to light may cause print quality problems.</p> <p>Warning—Potential Damage: Do not touch the photoconductor drum. Doing so may affect the quality of future print jobs.</p> <p>b Print the document.</p> <p>Does gray background appear on prints?</p>	<p>Go to step 5.</p>	<p>The problem is solved.</p>
<p>Step 5</p> <p>a Update the printer firmware. For more information, see the “Updating firmware” section.</p> <p>b Print the document.</p> <p>Does gray background appear on prints?</p>	<p>Go to step 6.</p>	<p>The problem is solved.</p>
<p>Step 6</p> <p>a Replace the imaging unit.</p> <p>b Print the document.</p> <p>Does gray background appear on prints?</p>	<p>Contact customer support.</p>	<p>The problem is solved.</p>

Horizontal light bands



Note: Before solving the problem, print the Print Quality Test Pages. From the control panel, navigate to **Settings > Troubleshooting > Print Quality Test Pages**. For non-touch-screen printer models, press **OK** to navigate through the settings.

Action	Yes	No
<p>a Check if the printer is using a genuine and supported Lexmark toner cartridge.</p> <p>Note: If the cartridge is not supported, then install a supported one.</p> <p>b Print the document.</p> <p>Do horizontal light bands appear on prints?</p>	<p>Contact customer support.</p>	<p>The problem is solved.</p>

Incorrect margins



Note: Before solving the problem, print the Print Quality Test Pages. From the control panel, navigate to **Settings > Troubleshooting > Print Quality Test Pages**. For non-touch-screen printer models, press **OK** to navigate through the settings.

Action	Yes	No
<p>Step 1</p> <p>a Adjust the paper guides to the correct position for the paper loaded.</p> <p>b Print the document.</p> <p>Are the margins correct?</p>	<p>The problem is solved.</p>	<p>Go to step 2.</p>

Action	Yes	No
<p>Step 2</p> <p>a Depending on your operating system, specify the paper size from the Printing Preferences or Print dialog.</p> <p>Notes:</p> <ul style="list-style-type: none"> • Make sure that the setting matches the paper loaded. • You can also change the setting from the printer control panel. Navigate to Settings > Paper > Tray Configuration > Paper Size/Type. <p>b Print the document.</p> <p>Are the margins correct?</p>	<p>The problem is solved.</p>	<p>Contact customer support.</p>

Light print



Note: Before solving the problem, print the Print Quality Test Pages. From the control panel, navigate to **Settings > Troubleshooting > Print Quality Test Pages**. For non-touch-screen printer models, press **OK** to navigate through the settings.

Action	Yes	No
<p>Step 1</p> <p>a Check if the printer is using a genuine and supported Lexmark toner cartridge.</p> <p>Note: If the cartridge is not supported, then install a supported one.</p> <p>b Print the document.</p> <p>Is the print light?</p>	<p>Go to step 2.</p>	<p>The problem is solved.</p>
<p>Step 2</p> <p>a Turn off the printer, wait for about 10 seconds, and then turn on the printer.</p> <p>b Increase toner darkness.</p> <p>From the control panel, navigate to:</p> <p>Settings > Print > Quality > Toner Darkness</p> <p>c Print the document.</p> <p>Is the print light?</p>	<p>Go to step 3.</p>	<p>The problem is solved.</p>

Action	Yes	No
<p>Step 3</p> <p>a Depending on your operating system, specify the paper type from the Printing Preferences or Print dialog.</p> <p>Notes:</p> <ul style="list-style-type: none"> • Make sure that the setting matches the paper loaded. • You can also change the setting on the printer control panel. Navigate to Settings > Paper > Tray Configuration > Paper Size/Type. <p>b Print the document.</p> <p>Is the print light?</p>	<p>Go to step 4.</p>	<p>The problem is solved.</p>
<p>Step 4</p> <p>a Depending on your operating system, specify the print resolution from the Printing Preferences or Print dialog.</p> <p>b Set the resolution to 600 dpi.</p> <p>c Print the document.</p> <p>Is the print light?</p>	<p>Go to step 5.</p>	<p>The problem is solved.</p>
<p>Step 5</p> <p>a Remove the imaging unit.</p> <p>Warning—Potential Damage: Do not expose the imaging unit to direct light for more than 10 minutes. Extended exposure to light can cause print quality problems.</p> <p>Warning—Potential Damage: Do not touch the photoconductor drum under the imaging unit. Doing so may affect the quality of future print jobs.</p> <p>b Firmly shake the imaging unit to redistribute the toner.</p> <p>c Insert the imaging unit.</p> <p>d Turn off the printer, wait for 10 seconds, and then turn on the printer.</p> <p>e Print the document.</p> <p>Is the print light?</p>	<p>Go to step 6.</p>	<p>The problem is solved.</p>
<p>Step 6</p> <p>a Check the status of the toner cartridge.</p> <p>From the control panel, navigate to:</p> <p>Settings > Reports > Device > Device Statistics</p> <p>b From the Supply Information section of the pages printed, check the status of the toner cartridge.</p> <p>Is the toner cartridge near end of life?</p>	<p>Go to step 7.</p>	<p>Contact customer support.</p>

Action	Yes	No
<p>Step 7</p> <p>a Replace the toner cartridge.</p> <p>b Print the document.</p> <p>Is the print light?</p>	Contact customer support .	The problem is solved.

Mottled print and dots



Note: Before solving the problem, print the Print Quality Test Pages. From the control panel, navigate to **Settings > Troubleshooting > Print Quality Test Pages**. For non-touch-screen printer models, press  to navigate through the settings.

Action	Yes	No
<p>Step 1</p> <p>a Check if the printer is using a genuine and supported Lexmark toner cartridge.</p> <p>Note: If the toner cartridge is not supported, then install a supported one.</p> <p>b Print the document.</p> <p>Is the print mottled?</p>	Go to step 2.	The problem is solved.
<p>Step 2</p> <p>Check the printer for leaked toner contamination.</p> <p>Is the printer free of leaked toner?</p>	Go to step 4.	Go to step 3.
<p>Step 3</p> <p>a Replace the toner cartridge.</p> <p>b Print the document.</p> <p>Is the print mottled?</p>	Go to step 4.	The problem is solved.
<p>Step 4</p> <p>Check the status of the imaging unit. From the control panel, navigate to:</p> <p>Status/Supplies > Supplies</p> <p>Is the imaging unit near end of life?</p>	Go to step 5.	Contact customer support .

Action	Yes	No
<p>Step 5</p> <p>a Replace the imaging unit.</p> <p>b Print the document.</p> <p>Is the print mottled?</p>	<p>Contact customer support.</p>	<p>The problem is solved.</p>

Paper curl



Action	Yes	No
<p>Step 1</p> <p>a Check if the paper loaded is supported. Note: If paper is not supported, then load a supported paper.</p> <p>b Print the document.</p> <p>Is the paper curled?</p>	<p>Go to step 2.</p>	<p>The problem is solved.</p>
<p>Step 2</p> <p>a Check if the printer is using a genuine and supported Lexmark toner cartridge. Note: If the cartridge is not supported, then install a supported one.</p> <p>b Print the document.</p> <p>Is the paper curled?</p>	<p>Go to step 3.</p>	<p>The problem is solved.</p>
<p>Step 3</p> <p>a Adjust the guides in the tray to the correct position for the paper loaded.</p> <p>b Print the document.</p> <p>Is the paper curled?</p>	<p>Go to step 4.</p>	<p>The problem is solved.</p>

Action	Yes	No
<p>Step 4</p> <p>a Depending on your operating system, specify the paper size and paper type from the Printing Preferences or Print dialog.</p> <p>Notes:</p> <ul style="list-style-type: none"> • Make sure that the settings match the paper loaded. • You can also change the setting on the printer control panel. Navigate to Settings > Paper > Tray Configuration > Paper Size/Type. For non-touch-screen printer models, press OK to navigate through the settings. <p>b Print the document.</p> <p>Is the paper curled?</p>	Go to step 5.	The problem is solved.
<p>Step 5</p> <p>a Remove paper, flip it over, and then reload paper.</p> <p>b Print the document.</p> <p>Is the paper curled?</p>	Go to step 6.	The problem is solved.
<p>Step 6</p> <p>a Load paper from a fresh package.</p> <p>Note: Paper absorbs moisture due to high humidity. Store paper in its original wrapper until you are ready to use it.</p> <p>b Print the document.</p> <p>Is the paper curled?</p>	Contact customer support .	The problem is solved.

Print crooked or skewed



Note: Before solving the problem, print the Print Quality Test Pages. From the control panel, navigate to **Settings > Troubleshooting > Print Quality Test Pages**. For non-touch-screen printer models, press **OK** to navigate through the settings.

Action	Yes	No
<p>Step 1</p> <p>a Adjust the guides in the tray to the correct position for the paper loaded.</p> <p>b Print the document.</p> <p>Is the print crooked or skewed?</p>	Go to step 2.	The problem is solved.
<p>Step 2</p> <p>a Load paper from a fresh package.</p> <p>Note: Paper absorbs moisture due to high humidity. Store paper in its original wrapper until you are ready to use it.</p> <p>b Print the document.</p> <p>Is the print crooked or skewed?</p>	Go to step 3.	The problem is solved.
<p>Step 3</p> <p>a Check if the paper loaded is supported.</p> <p>Note: If paper is not supported, then load a supported paper.</p> <p>b Print the document.</p> <p>Is the print crooked or skewed?</p>	Contact customer support .	The problem is solved.
<p>Step 4</p> <p>a For two-sided printing, check if the paper size setting in the duplex unit is set correctly.</p> <p>Note: Letter, legal, Oficio, or folio must be set to Letter.</p> <p>b Print the document.</p> <p>Is the print crooked or skewed?</p>	Contact customer support .	The problem is solved.

Solid black pages



Note: Before solving the problem, print the Print Quality Test Pages. From the control panel, navigate to **Settings > Troubleshooting > Print Quality Test Pages**. For non-touch-screen printer models, press  to navigate through the settings.

Action	Yes	No
<p>Step 1</p> <p>a Check if the printer is using a genuine and supported Lexmark toner cartridge.</p> <p>Note: If the toner cartridge is not supported, then install a supported one.</p> <p>b Print the document.</p> <p>Is the printer printing solid black pages?</p>	<p>Go to step 2.</p>	<p>The problem is solved.</p>
<p>Step 2</p> <p>a Remove, and then insert the imaging unit.</p> <p>Warning—Potential Damage: Do not expose the imaging unit to direct light for more than 10 minutes. Extended exposure to light may cause print quality problems.</p> <p>Warning—Potential Damage: Do not touch the photoconductor drum under the imaging unit. Doing so may affect the quality of future print jobs.</p> <p>b Print the document.</p> <p>Is the printer printing solid black pages?</p>	<p>Go to step 3.</p>	<p>The problem is solved.</p>
<p>Step 3</p> <p>a Remove the imaging unit.</p> <p>Warning—Potential Damage: Do not expose the imaging unit to direct light for more than 10 minutes. Extended exposure to light may cause print quality problems.</p> <p>Warning—Potential Damage: Do not touch the photoconductor drum under the imaging unit. Doing so may affect the quality of future print jobs.</p> <p>b Remove any packing material that is stuck on the imaging unit.</p> <div data-bbox="396 1373 786 1520" data-label="Image"> </div> <p>Note: Make sure to remove any obstruction between the charge roller and photoconductor drum.</p> <p>c Insert the imaging unit.</p> <p>d Print the document.</p> <p>Is the printer printing solid black pages?</p>	<p>Go to step 4.</p>	<p>The problem is solved.</p>
<p>Step 4</p> <p>Check the imaging unit for signs of damage.</p> <p>Is the imaging unit free from damage?</p>	<p>Contact customer support.</p>	<p>Go to step 5.</p>

Action	Yes	No
<p>Step 5</p> <p>a Replace the imaging unit.</p> <p>b Print the document.</p> <p>Is the printer printing solid black pages?</p>	<p>Contact customer support.</p>	<p>The problem is solved.</p>

Text or images cut off



Note: Before solving the problem, print the Print Quality Test Pages. From the control panel, navigate to **Settings > Troubleshooting > Print Quality Test Pages**. For non-touch-screen printer models, press  to navigate through the settings.

Action	Yes	No
<p>Step 1</p> <p>a Check if the printer is using a genuine and supported Lexmark toner cartridge.</p> <p>Note: If the toner cartridge is not supported, then install a supported one.</p> <p>b Print the document.</p> <p>Are text or images cut off?</p>	<p>Go to step 2.</p>	<p>The problem is solved.</p>
<p>Step 2</p> <p>a Remove, and then insert the imaging unit.</p> <p>Warning—Potential Damage: Do not expose the imaging unit to direct light for more than 10 minutes. Extended exposure to light may cause print quality problems.</p> <p>Warning—Potential Damage: Do not touch the photoconductor drum under the imaging unit. Doing so may affect the quality of future print jobs.</p> <p>b Print the document.</p> <p>Are text or images cut off?</p>	<p>Go to step 3.</p>	<p>The problem is solved.</p>

Action	Yes	No
<p>Step 3</p> <p>a Remove the imaging unit.</p> <p>Warning—Potential Damage: Do not expose the imaging unit to direct light for more than 10 minutes. Extended exposure to light may cause print quality problems.</p> <p>Warning—Potential Damage: Do not touch the photoconductor drum under the imaging unit. Doing so may affect the quality of future print jobs.</p> <p>b Remove any packing material that is stuck on the imaging unit.</p> <div data-bbox="396 638 786 783" style="text-align: center;">  </div> <p>Note: Make sure to remove any obstruction between the charge roller and photoconductor drum.</p> <p>c Insert the imaging unit.</p> <p>d Print the document.</p> <p>Are text or images cut off?</p>	<p>Go to step 4.</p>	<p>The problem is solved.</p>
<p>Step 4</p> <p>a Replace the imaging unit.</p> <p>b Print the document.</p> <p>Are text or images cut off?</p>	<p>Contact customer support.</p>	<p>The problem is solved.</p>

Toner easily rubs off



Note: Before solving the problem, print the Print Quality Test Pages. From the control panel, navigate to **Settings > Troubleshooting > Print Quality Test Pages**. For non-touch-screen printer models, press  to navigate through the settings.

Action	Yes	No
<p>Step 1</p> <p>a Check if the printer is using a genuine and supported Lexmark toner cartridge.</p> <p>Note: If the toner cartridge is not supported, then install a supported one.</p> <p>b Print the document.</p> <p>Does the toner easily rub off?</p>	Go to step 2.	The problem is solved.
<p>Step 2</p> <p>a Depending on your operating system, specify the paper type from the Printing Preferences or Print dialog.</p> <p>Notes:</p> <ul style="list-style-type: none"> • Make sure that the setting matches the paper loaded. • You can also change the setting on the printer control panel. <p>b Print the document.</p> <p>Does the toner easily rub off?</p>	Contact customer support .	The problem is solved.

Vertical dark bands



Note: Before solving the problem, print the Print Quality Test Pages. From the control panel, navigate to **Settings > Troubleshooting > Print Quality Test Pages**. For non-touch-screen printer models, press  to navigate through the settings.

Action	Yes	No
<p>Step 1</p> <p>a Check if the printer is using a genuine and supported Lexmark toner cartridge.</p> <p>Note: If the toner cartridge is not supported, then install a supported one.</p> <p>b Print the document.</p> <p>Do vertical dark bands appear on prints?</p>	Go to step 2.	The problem is solved.

Action	Yes	No
<p>Step 2</p> <p>a Remove the toner cartridge, and then remove the imaging unit.</p> <p>Warning—Potential Damage: Do not expose the imaging unit to direct light for more than 10 minutes. Extended exposure to light may cause print quality problems.</p> <p>Warning—Potential Damage: Do not touch the photoconductor drum under the imaging unit. Doing so may affect the quality of future print jobs.</p> <p>b Insert the imaging unit, and then insert the cartridge.</p> <p>c Print the document.</p> <p>Do vertical dark bands appear on prints?</p>	<p>Go to step 3.</p>	<p>The problem is solved.</p>
<p>Step 3</p> <p>a Remove the imaging unit.</p> <p>Warning—Potential Damage: Do not expose the imaging unit to direct light for more than 10 minutes. Extended exposure to light may cause print quality problems.</p> <p>Warning—Potential Damage: Do not touch the photoconductor drum under the imaging unit. Doing so may affect the quality of future print jobs.</p> <p>b Remove any packing material that is stuck on the imaging unit.</p> <div data-bbox="396 1094 786 1241" style="text-align: center;">  </div> <p>Note: Make sure to remove any obstruction between the charge roller and photoconductor drum.</p> <p>c Insert the imaging unit.</p> <p>d Print the document.</p> <p>Do vertical dark bands appear on prints?</p>	<p>Go to step 4.</p>	<p>The problem is solved.</p>
<p>Step 4</p> <p>a Check if a bright light enters the right side of the printer, and move the printer if necessary.</p> <p>b Print the document.</p> <p>Do vertical dark bands appear on prints?</p>	<p>Contact customer support.</p>	<p>The problem is solved.</p>

Vertical dark lines or streaks

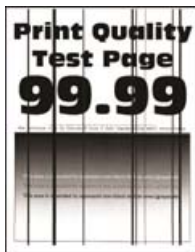



Action	Yes	No
<p>Step 1</p> <p>a From the control panel, navigate to: Settings > Troubleshooting > Cleaning the scanner</p> <p>b Print the document.</p> <p>Do vertical dark lines or streaks appear on prints?</p>	Go to step 3.	Go to step 2.
<p>Step 2</p> <p>a Using a damp, soft, lint-free cloth, clean the scanner. For more information, see “Cleaning the scanner” on page 124.</p> <p>b Copy the document using the ADF.</p> <p>Do vertical dark lines or streaks appear on prints?</p>	Contact customer support.	The problem is solved.
<p>Step 3</p> <p>a Check if the printer is using a genuine and supported Lexmark toner cartridge.</p> <p>Note: If the toner cartridge is not supported, then install a supported one.</p> <p>b Print the document.</p> <p>Do vertical dark lines or streaks appear on prints?</p>	Go to step 4.	The problem is solved.
<p>Step 4</p> <p>a Remove, and then insert the imaging unit.</p> <p>Warning—Potential Damage: Do not expose the imaging unit to direct light for more than 10 minutes. Extended exposure to light can cause print quality problems.</p> <p>Warning—Potential Damage: Do not touch the photoconductor drum under the imaging unit. Doing so may affect the quality of future print jobs.</p> <p>b Print the document.</p> <p>Do vertical dark lines or streaks appear on prints?</p>	Go to step 5.	The problem is solved.

Action	Yes	No
<p>Step 5</p> <p>a Replace the imaging unit.</p> <p>b Print the document.</p> <p>Do vertical dark lines or streaks appear on prints?</p>	<p>Contact customer support.</p>	<p>The problem is solved.</p>

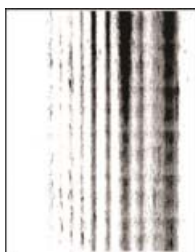
Vertical dark streaks with print missing



Note: Before solving the problem, print the Print Quality Test Pages. From the control panel, navigate to **Settings > Troubleshooting > Print Quality Test Pages**. For non-touch-screen printer models, press  to navigate through the settings.

Action	Yes	No
<p>Step 1</p> <p>a Remove the imaging unit.</p> <p>Warning—Potential Damage: Do not expose the imaging unit to direct light for more than 10 minutes. Extended exposure to light may cause print quality problems.</p> <p>Warning—Potential Damage: Do not touch the photoconductor drum under the imaging unit. Doing so may affect the quality of future print jobs.</p> <p>b Remove any packing material that is stuck on the imaging unit.</p> <div style="text-align: center;">  </div> <p>Note: Make sure to remove any obstruction between the charge roller and photoconductor drum.</p> <p>c Insert the imaging unit.</p> <p>d Print the document.</p> <p>Do vertical dark streaks with missing images appear on prints?</p>	<p>Go to step 2.</p>	<p>The problem is solved.</p>

Action	Yes	No
<p>Step 2</p> <p>a Check if the printer is using a genuine and supported Lexmark toner cartridge.</p> <p>Note: If the toner cartridge is not supported, then install a supported one.</p> <p>b Print the document.</p> <p>Do vertical dark streaks with missing images appear on prints?</p>	<p>Contact customer support.</p>	<p>The problem is solved.</p>

Vertical light bands



Note: Before solving the problem, print the Print Quality Test Pages. From the control panel, navigate to **Settings > Troubleshooting > Print Quality Test Pages**. For non-touch-screen printer models, press **OK** to navigate through the settings.

Action	Yes	No
<p>a Check if the printer is using a genuine and supported Lexmark toner cartridge.</p> <p>Note: If the cartridge is not supported, then install a supported one.</p> <p>b Print the document.</p> <p>Do vertical light bands appear on prints?</p>	<p>Contact customer support.</p>	<p>The problem is solved.</p>

Vertical white lines



Note: Before solving the problem, print the Print Quality Test Pages. From the control panel, navigate to **Settings > Troubleshooting > Print Quality Test Pages**. For non-touch-screen printer models, press **OK** to navigate through the settings.

Action	Yes	No
<p>Step 1</p> <p>a Check if the printer is using a genuine and supported Lexmark toner cartridge.</p> <p>Note: If the cartridge is not supported, then install a supported one.</p> <p>b Print the document.</p> <p>Do vertical white lines appear on prints?</p>	Go to step 2.	The problem is solved.
<p>Step 2</p> <p>a Depending on your operating system, specify the paper type from the Printing Preferences or Print dialog.</p> <p>Notes:</p> <ul style="list-style-type: none"> • Make sure that the setting matches the paper loaded. • You can also change the setting on the printer control panel. <p>b Print the document.</p> <p>Do vertical white lines appear on prints?</p>	Contact customer support .	The problem is solved.

Repeating defects



Note: Before solving the problem, print the Print Quality Test Pages. From the control panel, navigate to **Settings > Troubleshooting > Print Quality Test Pages**. For non-touch-screen printer models, press  to navigate through the settings.

Action	Yes	No
<p>Step 1</p> <p>Using the Print Quality Test Pages, check if the distance between the repeating defects is equal to any of the following:</p> <ul style="list-style-type: none"> • 97 mm (3.82 in.) • 47 mm (1.85 in.) • 38 mm (1.5 in.) <p>Does the distance between the repeating defects match any of the measurements?</p>	Go to step 2.	Take note of the distance, and then contact customer support .

Action	Yes	No
<p>Step 2</p> <p>a Replace the imaging unit.</p> <p>b Print the document.</p> <p>Do the repeating defects appear?</p>	<p>Contact customer support.</p>	<p>The problem is solved.</p>

Print jobs do not print

Action	Yes	No
<p>Step 1</p> <p>a From the document you are trying to print, open the Print dialog, and then check if you have selected the correct printer.</p> <p>b Print the document.</p> <p>Is the document printed?</p>	<p>The problem is solved.</p>	<p>Go to step 2.</p>
<p>Step 2</p> <p>a Check if the printer is on.</p> <p>b Resolve any error messages that appear on the display.</p> <p>c Print the document.</p> <p>Is the document printed?</p>	<p>The problem is solved.</p>	<p>Go to step 3.</p>
<p>Step 3</p> <p>a Check if the ports are working and if the cables are securely connected to the computer and the printer.</p> <p>For more information, see the setup documentation that came with the printer.</p> <p>b Print the document.</p> <p>Is the document printed?</p>	<p>The problem is solved.</p>	<p>Go to step 4.</p>
<p>Step 4</p> <p>a Turn off the printer, wait for about 10 seconds, and then turn on the printer.</p> <p>b Print the document.</p> <p>Is the document printed?</p>	<p>The problem is solved.</p>	<p>Go to step 5.</p>
<p>Step 5</p> <p>a Remove, and then reinstall the print driver.</p> <p>b Print the document.</p> <p>Is the document printed?</p>	<p>The problem is solved.</p>	<p>Contact customer support.</p>

Confidential and other held documents do not print

Action	Yes	No
<p>Step 1</p> <p>a From the control panel, check if the documents appear in the Held Jobs list.</p> <p>Note: If the documents are not listed, then print the documents using the Print and Hold options.</p> <p>b Print the documents.</p> <p>Are the documents printed?</p>	The problem is solved.	Go to step 2.
<p>Step 2</p> <p>The print job may contain a formatting error or invalid data.</p> <ul style="list-style-type: none"> • Delete the print job, and then send it again. • For PDF files, generate a new file, and then print the documents. <p>Are the documents printed?</p>	The problem is solved.	Go to step 3.
<p>Step 3</p> <p>If you are printing from the Internet, then the printer may be reading the multiple job titles as duplicates.</p> <p>For Windows users</p> <p>a Open the Printing Preferences dialog.</p> <p>b From the Print and Hold section, select Keep duplicate documents.</p> <p>c Enter a PIN.</p> <p>d Resend the print job.</p> <p>For Macintosh users</p> <p>a Save and name each job differently.</p> <p>b Send the job individually.</p> <p>Are the documents printed?</p>	The problem is solved.	Go to step 4.
<p>Step 4</p> <p>a Delete some held jobs to free up printer memory.</p> <p>b Resend the print job.</p> <p>Are the documents printed?</p>	The problem is solved.	Go to step 5.
<p>Step 5</p> <p>a Add printer memory.</p> <p>b Resend the print job.</p> <p>Are the documents printed?</p>	The problem is solved.	Contact customer support .

Job prints from the wrong tray or on the wrong paper

Action	Yes	No
<p>Step 1</p> <p>a Check if you are printing on the correct paper.</p> <p>b Print the document.</p> <p>Is the document printed on the correct paper?</p>	Go to step 2.	Load the correct paper size and paper type.
<p>Step 2</p> <p>a Depending on your operating system, specify the paper size and paper type from the Printing Preferences or Print dialog.</p> <p>Note: You can also change the settings on the printer control panel. Navigate to:</p> <p></p> <p>b Make sure that the settings match the paper loaded.</p> <p>c Print the document.</p> <p>Is the document printed on the correct paper?</p>	The problem is solved.	Go to step 3.
<p>Step 3</p> <p>a Check if the trays are linked.</p> <p>For more information, see “Linking trays” on page 20.</p> <p>b Print the document.</p> <p>Is the document printed from the correct tray?</p>	The problem is solved.	Contact customer support .

Slow printing

Action	Yes	No
<p>Step 1</p> <p>a Make sure that the printer is not in Eco-Mode and Quiet Mode.</p> <p>b Print the document.</p> <p>Is the printer still printing slow?</p>	Go to step 2.	The problem is solved.

Action	Yes	No
<p>Step 2</p> <p>a Depending on your operating system, specify the paper type from the Printing Preferences or Print dialog.</p> <p>Notes:</p> <ul style="list-style-type: none"> • Make sure that the setting matches the paper loaded in the tray. • You can also change the setting from the Paper menu on the printer control panel. <p>b Print the document.</p> <p>Is the printer still printing slow?</p>	Go to step 3.	The problem is solved.
<p>Step 3</p> <p>a Reduce the number of pages to print.</p> <p>b Print the document.</p> <p>Is the printer still printing slow?</p>	Go to step 4.	The problem is solved.
<p>Step 4</p> <p>a Connect the printer cable securely to the printer and the computer, print server, option, or other network device.</p> <p>b Print the document.</p> <p>Is the printer still printing slow?</p>	Go to step 5.	The problem is solved.
<p>Step 5</p> <p>a From the Quality menu on the control panel, set Print Resolution to 600 dpi.</p> <p>b Print the document.</p> <p>Is the printer still printing slow?</p>	Go to step 6.	The problem is solved.
<p>Step 6</p> <p>a Make sure that the printer is not overheating.</p> <p>Notes:</p> <ul style="list-style-type: none"> • Allow the printer to cool down after a very long print job. • Observe the recommended ambient temperature for the printer. For more information, see “Selecting a location for the printer” on page 12. <p>b Print the document.</p> <p>Is the printer still printing slow?</p>	Go to step 7.	The problem is solved.
<p>Step 7</p> <p>a Add more printer memory.</p> <p>b Print the document.</p> <p>Is the printer still printing slow?</p>	Contact customer support .	The problem is solved.

The printer is not responding

Action	Yes	No
<p>Step 1 Check if the power cord is connected to the electrical outlet.</p> <p> CAUTION—POTENTIAL INJURY: To avoid the risk of fire or electrical shock, connect the power cord to an appropriately rated and properly grounded electrical outlet that is near the product and easily accessible.</p> <p>Is the printer responding?</p>	The problem is solved.	Go to step 2.
<p>Step 2 Check if the electrical outlet is turned off by a switch or breaker.</p> <p>Is the electrical outlet turned off by a switch or breaker?</p>	Turn on the switch or reset the breaker.	Go to step 3.
<p>Step 3 Check if the printer is on.</p> <p>Is the printer on?</p>	Go to step 4.	Turn on the printer.
<p>Step 4 Check if the printer is in Sleep or Hibernate mode.</p> <p>Is the printer in Sleep or Hibernate mode?</p>	Press the power button to wake the printer.	Go to step 5.
<p>Step 5 Check if the cables connecting the printer and the computer are inserted to the correct ports.</p> <p>Are the cables inserted to the correct ports?</p>	Go to step 6.	Insert the cables to the correct ports.
<p>Step 6 Turn off the printer, install the hardware options, and then turn on the printer. For more information, see the documentation that came with the option.</p> <p>Is the printer responding?</p>	The problem is solved.	Go to step 7.
<p>Step 7 Install the correct print driver.</p> <p>Is the printer responding?</p>	The problem is solved.	Go to step 8.
<p>Step 8 Turn off the printer, wait for about 10 seconds, and then turn on the printer.</p> <p>Is the printer responding?</p>	The problem is solved.	Contact customer support .

Adjusting toner darkness

1 From the control panel, navigate to:



2 Select **Toner Darkness**, and then press **OK**.

3 Adjust the setting, and then press **OK**.

Network connection problems

Cannot open Embedded Web Server

Action	Yes	No
<p>Step 1 Check if the printer is on.</p> <p>Is the printer on?</p>	Go to step 2.	Turn on the printer.
<p>Step 2 Make sure that the printer IP address is correct.</p> <p>Notes:</p> <ul style="list-style-type: none"> • View the IP address on the home screen. • An IP address appears as four sets of numbers separated by periods, such as 123.123.123.123. <p>Is the printer IP address correct?</p>	Go to step 3.	Type the correct printer IP address in the address field.
<p>Step 3 Check if you are using a supported browser:</p> <ul style="list-style-type: none"> • Internet Explorer version 11 or later • Microsoft Edge • Safari version 6 or later • Google Chrome™ version 32 or later • Mozilla Firefox version 24 or later <p>Is your browser supported?</p>	Go to step 4.	Install a supported browser.
<p>Step 4 Check if the network connection is working.</p> <p>Is the network connection working?</p>	Go to step 5.	Contact your administrator.

Action	Yes	No
<p>Step 5 Make sure that the cable connections to the printer and print server are secure. For more information, see the documentation that came with the printer.</p> <p>Are the cable connections secure?</p>	Go to step 6.	Secure the cable connections.
<p>Step 6 Check if the web proxy servers are disabled.</p> <p>Are the web proxy servers disabled?</p>	Go to step 7.	Contact your administrator.
<p>Step 7 Access the Embedded Web Server.</p> <p>Did the Embedded Web Server open?</p>	The problem is solved.	Contact customer support .

Enabling the USB port

1 From the control panel, navigate to:



2 Select **Enable USB Port**, and then press **OK**.

Checking the printer connectivity

1 From the control panel, navigate to:



2 Select **Network Setup Page**, and then press **OK**.

3 Check the first section of the network setup page, and confirm that the status is connected.

If the status is not connected, then the LAN drop may be inactive, or the network cable may be unplugged or malfunctioning. Contact your administrator for assistance.

Internal option problems

Cannot detect internal option

Action	Yes	No
<p>Step 1 Turn off the printer, wait for about 10 seconds, and then turn on the printer.</p> <p>Does the internal option operate correctly?</p>	The problem is solved.	Go to step 2.
<p>Step 2 Print the Menu Settings Page, and then check if the internal option appears in the Installed Features list.</p> <p>Is the internal option listed in the menu settings page?</p>	Go to step 4.	Go to step 3.
<p>Step 3 Check if the internal option is installed properly into the controller board.</p> <ul style="list-style-type: none"> a Turn off the printer, and then unplug the power cord from the electrical outlet. b Make sure that the internal option is installed in the appropriate connector in the controller board. c Connect the power cord to the electrical outlet, and then turn on the printer. <p> CAUTION—POTENTIAL INJURY: To avoid the risk of fire or electrical shock, connect the power cord to an appropriately rated and properly grounded electrical outlet that is near the product and easily accessible.</p> <p>Does the internal option operate correctly?</p>	The problem is solved.	Go to step 4.
<p>Step 4</p> <ul style="list-style-type: none"> a Check if the internal option is available in the print driver. Note: If necessary, manually add the internal option in the print driver to make it available for print jobs. For more information, see “Adding available options in the print driver” on page 21. b Resend the print job. <p>Does the internal option operate correctly?</p>	The problem is solved.	Contact customer support .

Issues with supplies

Replace cartridge, printer region mismatch

To correct this problem, purchase a cartridge with the correct region that matches the printer region, or purchase a worldwide cartridge.

- The first number in the message after 42 indicates the region of the printer.
- The second number in the message after 42 indicates the region of the cartridge.

Printer and toner cartridge regions

Region	Numeric code
Worldwide or Undefined region	0
North America (United States, Canada)	1
European Economic Area, Western Europe, Nordic countries, Switzerland	2
Asia Pacific	3
Latin America	4
Rest of Europe, Middle East, Africa	5
Australia, New Zealand	6
Invalid region	9

Note: To find the region settings of the printer and toner cartridge, print the print quality test pages. From the control panel, navigate to: **Settings > Troubleshooting > Print Quality Test Pages.**

Refilled regular [color] cartridge

The printer has detected a Lexmark Regular cartridge that has been refilled with non-genuine toner by a party other than Lexmark.

Select **OK** to continue.

All printer component life indicators are designed to function with Lexmark supplies and parts and may deliver unpredictable results when using supplies or parts in your Lexmark printer that are remanufactured by parties other than Lexmark.

For more information, see the printer statement of limited warranty.

Non-Lexmark supply

The printer has detected a non-Lexmark supply or part installed in the printer.

Your Lexmark printer is designed to function best with genuine Lexmark supplies and parts. Use of third-party supplies or parts may affect the performance, reliability, or life of the printer and its imaging components.

All life indicators are designed to function with Lexmark supplies and parts and may deliver unpredictable results if third-party supplies or parts are used. Imaging component usage beyond the intended life may damage your Lexmark printer or associated components.





Warning—Potential Damage: Use of third-party supplies or parts can affect warranty coverage. Damage caused by the use of third-party supplies or parts may not be covered by the warranty.

To accept any and all of these risks and to proceed with the use of non-genuine supplies or parts in your printer, from the control panel, press and hold **X** and  simultaneously for 15 seconds.

If you do not want to accept these risks, then remove the third-party supply or part from your printer and install a genuine Lexmark supply or part. For more information, see [“Using genuine Lexmark parts and supplies” on page 127.](#)

If the printer does not print after pressing and holding **X** and  simultaneously for 15 seconds, then reset the supply usage counter.

1 From the control panel, navigate to:

Settings >  > **Device** >  > **Maintenance** >  > **Config Menu** >  > **Supply Usage And Counters** > 

2 Select the part or supply that you want to reset, and then select **Start**.





3 Read the warning message, and then select **Continue**.

4 Press and hold **X** and  simultaneously for 15 seconds to clear the message.





Note: If you are unable to reset the supply usage counters, then return the item to the place of purchase.

Paper feed problems





Envelope seals when printing

Action	Yes	No
<p>Step 1</p> <p>a Use an envelope that has been stored in a dry environment. Note: Printing on envelopes with high moisture content can seal the flaps.</p> <p>b Send the print job.</p> <p>Does the envelope seal when printing?</p>	Go to step 2.	The problem is solved.
<p>Step 2</p> <p>a Make sure that the paper type is set to Envelope. From the control panel, navigate to:  > Settings >  > Paper >  > Tray Configuration >  > Paper Size/Type</p> <p>b Send the print job.</p> <p>Does the envelope seal when printing?</p>	Contact customer support .	The problem is solved.

Collated printing does not work





Action	Yes	No
<p>Step 1</p> <p>a From the control panel, navigate to:</p> <p style="padding-left: 40px;">Settings >  > Print >  > Layout >  > Collate > </p> <p>b Set Collate to On [1,2,1,2,1,2], and then press .</p> <p>c Print the document.</p> <p>Is the document collated correctly?</p>	<p>The problem is solved.</p>	<p>Go to step 2.</p>
<p>Step 2</p> <p>a From the document that you are trying to print, open the Print dialog, and then select Collate.</p> <p>b Print the document.</p> <p>Is the document collated correctly?</p>	<p>The problem is solved.</p>	<p>Go to step 3.</p>
<p>Step 3</p> <p>a Reduce the number of pages to print.</p> <p>b Print the document.</p> <p>Are the pages collated correctly?</p>	<p>The problem is solved.</p>	<p>Contact customer support.</p>

Tray linking does not work





Action	Yes	No
<p>Step 1</p> <p>a Check if the trays contain the same paper size and paper type.</p> <p>b Check if the paper guides are positioned correctly.</p> <p>c Print the document.</p> <p>Do the trays link correctly?</p>	<p>The problem is solved.</p>	<p>Go to step 2.</p>
<p>Step 2</p> <p>a From the control panel, navigate to:</p> <p style="padding-left: 40px;"> > Settings >  > Paper >  > Tray Configuration >  > Paper Size/Type > </p> <p>b Set the paper size and paper type to match the paper loaded in the linked trays.</p> <p>c Print the document.</p> <p>Do the trays link correctly?</p>	<p>The problem is solved.</p>	<p>Go to step 3.</p>

Action	Yes	No
<p>Step 3</p> <p>a Make sure that Tray Linking is set to Automatic. For more information, see “Linking trays” on page 20.</p> <p>b Print the document.</p> <p>Do the trays link correctly?</p>	<p>The problem is solved.</p>	<p>Contact customer support.</p>

Paper frequently jams

Action	Yes	No
<p>Step 1</p> <p>a Remove the tray.</p> <p>b Check if paper is loaded correctly.</p> <p>Notes:</p> <ul style="list-style-type: none"> • Make sure that the paper guides are positioned correctly. • Make sure that the stack height is below the maximum paper fill indicator. • Make sure to print on recommended paper size and type. <p>c Insert the tray.</p> <p>d Print the document.</p> <p>Do paper jams occur frequently?</p>	<p>Go to step 2.</p>	<p>The problem is solved.</p>
<p>Step 2</p> <p>a From the control panel, navigate to:</p> <p> > Settings >  > Paper >  > Tray Configuration >  > Paper Size/Type > </p> <p>b Set the correct paper size and type.</p> <p>c Print the document.</p> <p>Do paper jams occur frequently?</p>	<p>Go to step 3.</p>	<p>The problem is solved.</p>
<p>Step 3</p> <p>a Load paper from a fresh package.</p> <p>Note: Paper absorbs moisture due to high humidity. Store paper in its original wrapper until you are ready to use it.</p> <p>b Print the document.</p> <p>Do paper jams occur frequently?</p>	<p>Contact customer support.</p>	<p>The problem is solved.</p>

Jammed pages are not reprinted

Action	Yes	No
<p>1 From the control panel, navigate to:</p> <p>Settings >  > Device >  > Notifications >  > Jam Content Recovery > </p> <p>2 In the Jam Recovery menu, select On or Auto, and then press .</p> <p>Are the jammed pages reprinted?</p>	The problem is solved.	Contact customer support .

E-mailing problems

Cannot send e-mails

Action	Yes	No
<p>Step 1</p> <p>Make sure that the e-mail SMTP settings are configured correctly. For more information, see “Configuring the e-mail SMTP settings” on page 29.</p> <p>Can you send an e-mail?</p>	The problem is solved.	Go to step 2.
<p>Step 2</p> <p>Make sure that you are using the correct password. Depending on your e-mail service provider, use your account password, app password, or authentication password. For more information, see “Configuring the e-mail SMTP settings” on page 29.</p> <p>Can you send an e-mail?</p>	The problem is solved.	Go to step 3.
<p>Step 3</p> <p>Make sure that the printer is connected to a network and that the network is connected to the Internet.</p> <p>Can you send an e-mail?</p>	The problem is solved.	Contact customer support .

Faxing problems

Caller ID is not shown

Action	Yes	No
<p>Enable caller ID.</p> <p>From the control panel, navigate to:</p> <p>Settings > OK > Fax > OK > Fax Defaults > OK > Fax Setup > OK > Fax Receive Settings > OK > Admin Controls > OK > Enable Caller ID > OK</p> <p>Does the caller ID appear?</p>	<p>The problem is solved.</p>	<p>Contact customer support.</p>

Cannot set up etherFAX





Action	Yes	No
<p>Step 1</p> <p>Check the printer connectivity.</p> <p>a Print the Network Setup Page. From the control panel, navigate to:</p> <p>Settings > OK > Reports > OK > Network > OK > Network Setup Page > OK</p> <p>b Check the network status.</p> <p>Is the printer connected to the network?</p>	<p>Go to step 3.</p>	<p>Go to step 2.</p>
<p>Step 2</p> <p>Make sure that the printer is connected to a network and that the network is connected to the Internet.</p> <p>Can you set up etherFAX?</p>	<p>The problem is solved.</p>	<p>Go to step 3.</p>
<p>Step 3</p> <p>Make sure that etherFAX is setup correctly. For more information, see “Setting up the fax function using etherFAX” on page 40.</p> <p>Can you set up etherFAX?</p>	<p>The problem is solved.</p>	<p>Go to https://www.etherfax.net/lexmark.</p>

Cannot send or receive faxes using analog fax

Action	Yes	No
<p>Step 1 Resolve any error messages that appear on the display.</p> <p>Can you send or receive a fax?</p>	The problem is solved.	Go to step 2.
<p>Step 2 Make sure that the cable connections for the following equipment are secure:</p> <ul style="list-style-type: none"> • Telephone • Handset • Answering machine <p>Can you send or receive a fax?</p>	The problem is solved.	Go to step 3.
<p>Step 3 Check for a dial tone.</p> <ul style="list-style-type: none"> • Call the fax number to check if it is working properly. • If you are using the On Hook Dial feature, then turn up the volume to check if you hear a dial tone. <p>Can you hear a dial tone?</p>	Go to step 5.	Go to step 4.
<p>Step 4 Check the telephone wall jack.</p> <ol style="list-style-type: none"> a Connect the analog telephone directly to the wall jack. b Listen for a dial tone. c If you do not hear a dial tone, then use a different telephone cable. d If you still do not hear a dial tone, then connect the analog telephone to a different wall jack. e If you hear a dial tone, then connect the printer to that wall jack. <p>Can you send or receive a fax?</p>	The problem is solved.	Go to step 5.

Action	Yes	No
<p>Step 5</p> <p>Check if the printer is connected to an analog phone service or to the correct digital connector.</p> <ul style="list-style-type: none"> • If you are using an Integrated Services for Digital Network (ISDN) telephone service, then connect to an analog telephone port of an ISDN terminal adapter. For more information, contact your ISDN provider. • If you are using DSL, then connect to a DSL filter or router that supports analog use. For more information, contact your DSL provider. • If you are using a private branch exchange (PBX) telephone service, then make sure that you are connecting to an analog connection on the PBX. If none exists, then consider installing an analog telephone line for the fax machine. <p>Can you send or receive a fax?</p>	<p>The problem is solved.</p>	<p>Go to step 6.</p>
<p>Step 6</p> <p>Temporarily disconnect other equipment and disable other telephone services.</p> <ol style="list-style-type: none"> a Disconnect other equipment (such as answering machines, computers, modems, or telephone line splitters) between the printer and the telephone line. b Disable call waiting and voice mail. For more information, contact your telephone company. <p>Can you send or receive a fax?</p>	<p>The problem is solved.</p>	<p>Go to step 7.</p>
<p>Step 7</p> <p>Scan the original document one page at a time.</p> <ol style="list-style-type: none"> a Dial the fax number. b Scan the document. <p>Can you send or receive a fax?</p>	<p>The problem is solved.</p>	<p>Contact customer support.</p>

Cannot send or receive faxes using etherFAX

Action	Yes	No
<p>Step 1 Make sure that the printer is connected to a network and that the network is connected to the Internet.</p> <p>Can you send or receive faxes using etherFAX?</p>	The problem is solved.	Go to step 2.
<p>Step 2 a From the control panel, navigate to: Settings >  > Fax >  > Fax Setup >  > General Fax Settings > </p> <p>b Make sure that you have the correct fax number. c Make sure that Fax Transport is set to etherFAX.</p> <p>Can you send or receive faxes using etherFAX?</p>	The problem is solved.	Go to step 3.
<p>Step 3 Split large documents into smaller file sizes.</p> <p>Can you send or receive faxes using etherFAX?</p>	The problem is solved.	Go to https://www.etherfax.net/lexmark .

Can receive but not send faxes using analog fax

Action	Yes	No
<p>Step 1 Load an original document properly into the ADF tray or on the scanner glass.</p> <p>Can you send faxes?</p>	The problem is solved.	Go to step 2.
<p>Step 2 Set up the shortcut number properly.</p> <ul style="list-style-type: none"> • Check if the shortcut number is set for the telephone number that you want to dial. • Dial the telephone number manually. <p>Can you send faxes?</p>	The problem is solved.	Contact customer support .

Can send but not receive faxes using analog fax

Action	Yes	No
<p>Step 1 Make sure that the paper source is not empty.</p> <p>Can you receive faxes?</p>	The problem is solved.	Go to step 2.
<p>Step 2 Check the ring count delay settings. From the control panel, navigate to:</p> <p>Settings > OK > Fax > OK > Fax Setup > OK > Fax Receive Settings > OK > Rings to Answer > OK</p> <p>Can you receive faxes?</p>	The problem is solved.	Go to step 3.
<p>Step 3 If the printer is printing blank pages, then see “Blank or white pages” on page 157.</p> <p>Can you receive faxes?</p>	The problem is solved.	Contact customer support .

Poor fax print quality

Action	Yes	No
<p>Step 1 Enhance the print quality.</p> <p>a Open a web browser, and then type the printer IP address in the address field.</p> <p>Notes:</p> <ul style="list-style-type: none"> View the printer IP address on the printer home screen. The IP address appears as four sets of numbers separated by periods, such as 123.123.123.123. If you are using a proxy server, then temporarily disable it to load the web page correctly. <p>b Click Settings > Print > Quality.</p> <p>c Adjust the settings.</p> <p>d Apply the changes.</p> <p>Is the fax print quality satisfactory?</p>	The problem is solved.	Go to step 2.

Action	Yes	No
<p>Step 2 Decrease the incoming fax transmission speed.</p> <p>a Open a web browser, and then type the printer IP address in the address field.</p> <p>Notes:</p> <ul style="list-style-type: none"> View the printer IP address on the printer home screen. The IP address appears as four sets of numbers separated by periods, such as 123.123.123.123. If you are using a proxy server, then temporarily disable it to load the web page correctly. <p>b Click Settings > Fax > Analog Fax Setup > Fax Receive Settings > Admin Controls.</p> <p>c Select a Max Speed setting.</p> <p>d Apply the changes.</p> <p>Is the fax print quality satisfactory?</p>	<p>The problem is solved.</p>	<p>Go to step 3.</p>
<p>Step 3 Replace the toner cartridge. For more information, see the instruction sheet that came with the supply.</p> <p>Is the fax print quality satisfactory?</p>	<p>The problem is solved.</p>	<p>Contact customer support.</p>

Missing information on the fax cover page

Action	No	Yes
<p>a Turn off the printer, wait for about 10 seconds, and then turn on the printer.</p> <p>b Send or retrieve the fax.</p> <p>Is there missing information on the fax cover page?</p>	<p>The problem is solved.</p>	<p>Contact customer support.</p>

Cannot send the fax cover page from the computer

Action	Yes	No
<p>Step 1</p> <p>a Make sure that the print driver is updated. For more information, see “Installing the printer software” on page 209.</p> <p>b Send the fax.</p> <p>Can you send the fax cover page?</p>	<p>The problem is solved.</p>	<p>Go to step 2.</p>

Action	Yes	No
<p>Step 2</p> <ul style="list-style-type: none"> a From the document that you are trying to fax, open the Print dialog. b Select the printer, and then click Properties, Preferences, Options, or Setup. c Click Fax, and then clear the Always display settings prior to faxing setting. d Send the fax. <p>Can you send the fax cover page?</p>	<p>The problem is solved.</p>	<p>Contact customer support.</p>

Scanning problems

Cannot scan from a computer

Action	Yes	No
<p>Step 1</p> <ul style="list-style-type: none"> a Turn off the printer, wait for about 10 seconds, and then turn it back on. b Resend the scan job. <p>Can you send the scan job?</p>	<p>The problem is solved.</p>	<p>Go to step 2.</p>
<p>Step 2</p> <ul style="list-style-type: none"> a Make sure that the cables between the printer and the print server are secure. For more information, see the setup documentation that came with the printer. b Resend the scan job. <p>Can you send the scan job?</p>	<p>The problem is solved.</p>	<p>Contact customer support.</p>

Partial copies of document or photo

Action	Yes	No
<p>Step 1</p> <ul style="list-style-type: none"> a Make sure that the document or photo is loaded facedown on the upper left corner of the scanner glass. b Copy the document or photo. <p>Is the document or photo copied correctly?</p>	<p>The problem is solved.</p>	<p>Go to step 2.</p>

Action	Yes	No
<p>Step 2</p> <p>a Match the paper size setting and the paper loaded in the tray.</p> <p>b Copy the document or photo.</p> <p>Is the document or photo copied correctly?</p>	The problem is solved.	Contact customer support .

Poor copy quality

Action	Yes	No
<p>Step 1</p> <p>a Using a damp, soft, lint-free cloth, wipe the scanner glass and the ADF glass.</p> <p>b Make sure that the document or photo is loaded facedown on the upper-left corner of the scanner glass.</p> <p>c Copy the document or photo.</p> <p>Is the copy quality satisfactory?</p>	The problem is solved.	Go to step 2.
<p>Step 2</p> <p>a Check the quality of the original document or photo.</p> <p>b Adjust the scan quality settings.</p> <p>c Copy the document or photo.</p> <p>Is the copy quality satisfactory?</p>	The problem is solved.	Contact customer support .

Vertical dark streaks on output when scanning from the ADF

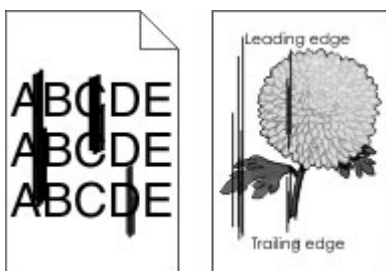

Action	Yes	No
<p>Step 1</p> <p>a Open the scanner cover.</p> <p>b Using a damp, soft, lint-free cloth, wipe the ADF glass and the white underside of the ADF cover.</p> <p>c Close the scanner cover.</p> <p>Do vertical streaks still appear on scanned documents?</p>	Go to step 2.	The problem is solved.

Action	Yes	No
<p>Step 2</p> <p>a Open door C.</p> <p>b Using a damp, soft, lint-free cloth, wipe the ADF glass and the white underside of the ADF cover.</p> <p>c Close the door.</p> <p>Do vertical streaks still appear on scanned documents?</p>	Contact customer support .	The problem is solved.

Scan job was not successful

Action	Yes	No
<p>Step 1</p> <p>Check the cable connections.</p> <p>a Make sure that the Ethernet or USB cable is securely connected to the computer and the printer.</p> <p>b Resend the scan job.</p> <p>Is the scan job successful?</p>	The problem is solved.	Go to step 2.
<p>Step 2</p> <p>Check the file you want to scan.</p> <p>a Make sure that the file name is not already used in the destination folder.</p> <p>b Make sure that the document or photo you want to scan is not open in another application.</p> <p>c Resend the scan job.</p> <p>Is the scan job successful?</p>	The problem is solved.	Go to step 3.
<p>Step 3</p> <p>a Make sure that the Append time stamp or the Overwrite existing file check box is selected in the destination configuration settings.</p> <p>b Resend the scan job.</p> <p>Is the scan job successful?</p>	The problem is solved.	Contact customer support .

Scanner does not close

Action	Yes	No
<p>Remove obstructions that keep the scanner cover open.</p> <p>Did the scanner cover close correctly?</p>	The problem is solved.	Contact customer support .

Scanning takes too long or freezes the computer







Action	Yes	No
Close all applications that are interfering with the scan. Does scanning take too long or freeze the computer?	Contact customer support .	The problem is solved.

Scanner does not respond

Action	Yes	No
Step 1 a Check if the power cord is connected properly to the printer and the electrical outlet.  CAUTION—POTENTIAL INJURY: To avoid the risk of fire or electrical shock, connect the power cord to an appropriately rated and properly grounded electrical outlet that is near the product and easily accessible. b Copy or scan the document. Is the scanner responding?	The problem is solved.	Go to step 2.
Step 2 a Check if the printer is turned on. b Resolve any error messages that appear on the display. c Copy or scan the document. Is the scanner responding?	The problem is solved.	Go to step 3.
Step 3 a Turn off the printer, wait for about 10 seconds, and then turn the printer on. b Copy or scan the document. Is the scanner responding?	The problem is solved.	Contact customer support .

Adjusting scanner registration

1 From the control panel, navigate to:

 > **Settings** >  > **Device** >  > **Maintenance** >  > **Config Menu** >  > **Scanner Configuration**
 >  > **Scanner Manual Registration** > 

2 Select **Print Quick Test**, and then press .

3 Place the Print Quick Test page on the scanner glass, and then select **Flatbed Registration**.

4 Select **Copy Quick Test**, and then press .





5 Compare the Copy Quick Test page with the original document.

Note: If the margins of the test page are different from the original document, then adjust Left Margin and Top Margin.

6 Repeat [step 4](#) and [step 5](#) until the margins of the Copy Quick Test page closely match the original document.

Adjusting ADF registration

1 From the control panel, navigate to:

 > **Settings** >  > **Device** >  > **Maintenance** >  > **Config Menu** >  > **Scanner Configuration**
>  > **Scanner Manual Registration** > 

2 Select **Print Quick Test**, and then press .

3 Place the Print Quick Test page on the ADF tray.

4 Select **Front ADF Registration** or **Rear ADF Registration**.

Notes:

- To align Front ADF Registration, place the test page faceup, short edge first into the ADF.
- To align Rear ADF Registration, place the test page facedown, short edge first into the ADF.

5 Select **Copy Quick Test**, and then press .

6 Compare the Copy Quick Test page with the original document.

Note: If the margins of the test page are different from the original document, then adjust Horizontal Adjust and Top Margin.

7 Repeat [step 5](#) and [step 6](#) until the margins of the Copy Quick Test page closely match the original document.

Contacting customer support

Before contacting customer support, make sure to have the following information:

- Printer problem
- Error message
- Printer model type and serial number

Go to <http://support.lexmark.com> to receive e-mail or chat support, or browse through the library of manuals, support documentation, drivers, and other downloads.

Technical support via telephone is also available. In the U.S. or Canada, call 1-800-539-6275. For other countries or regions, go to <http://support.lexmark.com>.

Upgrading and migrating

Hardware

Available internal options

- User flash
- Font cards

Installing a memory card



CAUTION—SHOCK HAZARD: To avoid the risk of electrical shock, if you are accessing the controller board or installing optional hardware or memory devices sometime after setting up the printer, then turn the printer off, and unplug the power cord from the electrical outlet before continuing. If you have any other devices attached to the printer, then turn them off as well, and unplug any cables going into the printer.

- 1 Turn off the printer.
- 2 Unplug the power cord from the electrical outlet, and then from the printer.
- 3 Open the controller board access cover.

Warning—Potential Damage: Controller board electronic components are easily damaged by static electricity. Touch a metal surface on the printer before touching any controller board components or connectors.

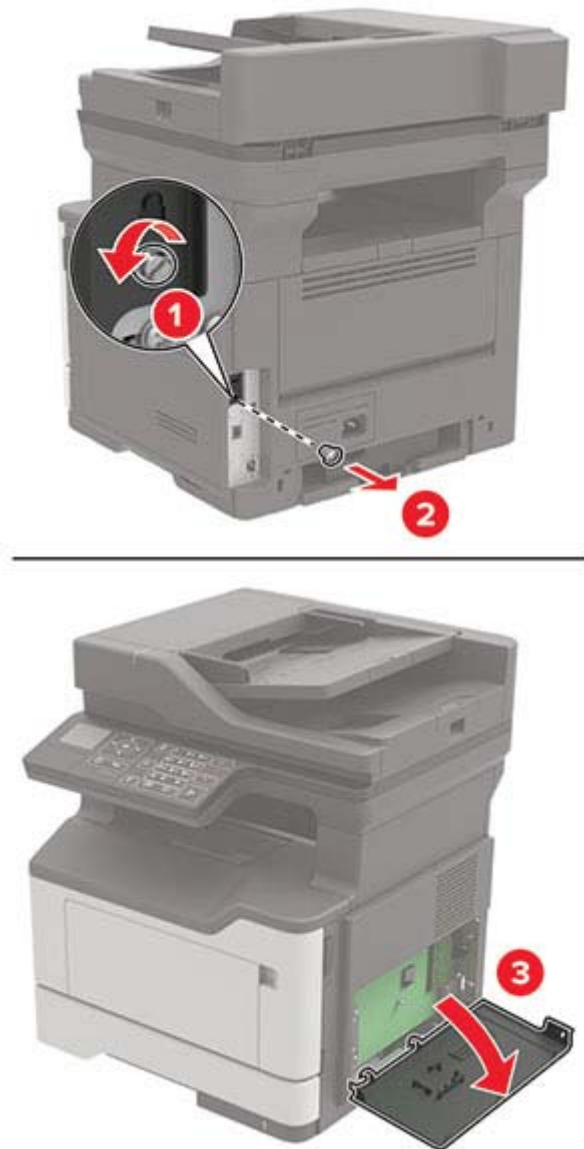

4 Unpack the memory card.

Warning—Potential Damage: Do not touch the connection points along the edge of the card.

5 Insert the memory card until it *clicks* into place.

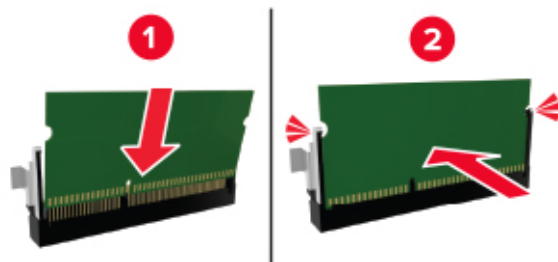

6 Close the controller board access cover.

7 Connect the power cord to the printer, and then to the electrical outlet.



CAUTION—POTENTIAL INJURY: To avoid the risk of fire or electrical shock, connect the power cord to an appropriately rated and properly grounded electrical outlet that is near the product and easily accessible.

8 Turn on the printer.

Installing an optional card



CAUTION—SHOCK HAZARD: To avoid the risk of electrical shock, if you are accessing the controller board or installing optional hardware or memory devices sometime after setting up the printer, then turn the printer off, and unplug the power cord from the electrical outlet before continuing. If you have any other devices attached to the printer, then turn them off as well, and unplug any cables going into the printer.

1 Turn off the printer.

2 Unplug the power cord from the electrical outlet, and then from the printer.

3 Open the controller board access cover.

Warning—Potential Damage: Controller board electronic components are easily damaged by static electricity. Touch a metal surface on the printer before touching any components or connectors.

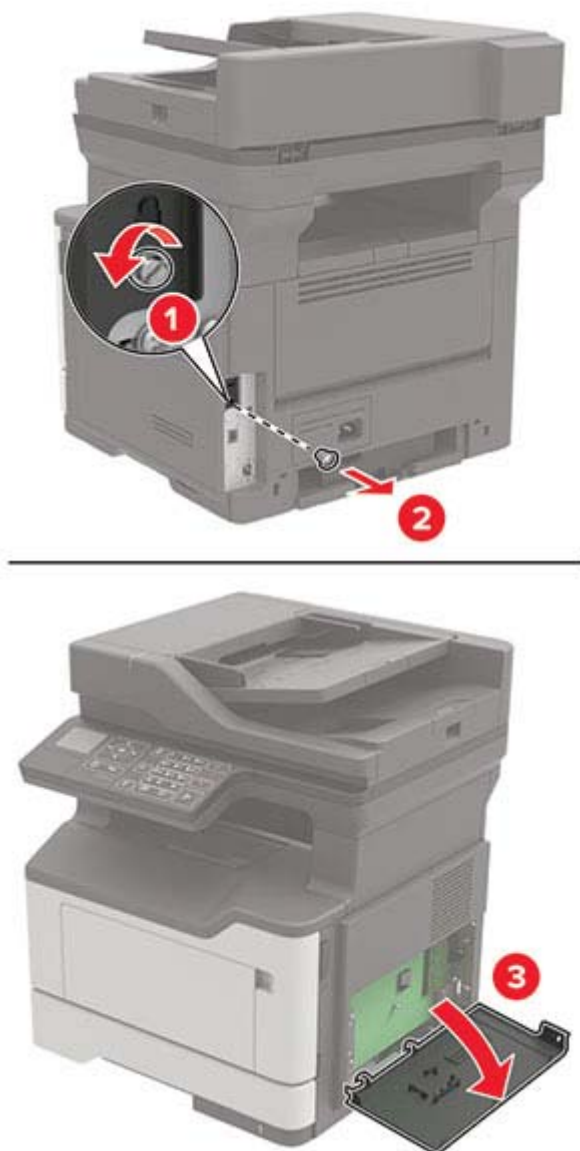

4 Unpack the optional card.

Warning—Potential Damage: Do not touch the connection points along the edge of the card.

- 5 Push the card firmly into place.

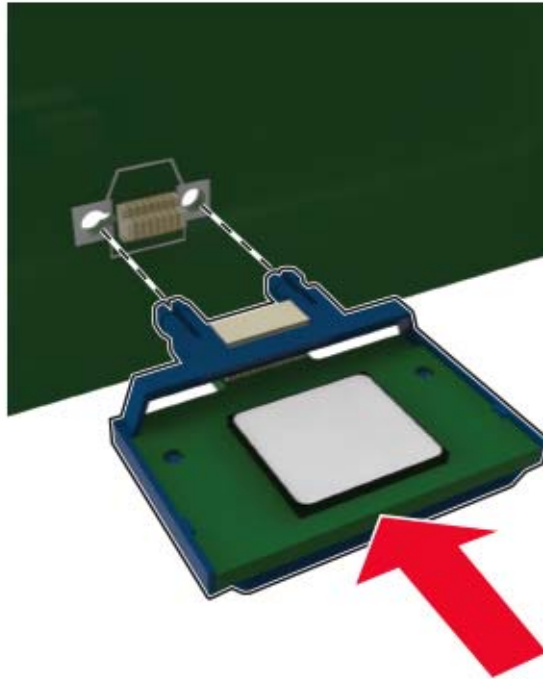

Note: The entire length of the connector on the card must touch and be flush against the controller board.

Warning—Potential Damage: Improper installation of the card may cause damage to the card and the controller board.

- 6 Close the access cover.
- 7 Connect the power cord to the printer, and then to the electrical outlet.

CAUTION—POTENTIAL INJURY: To avoid the risk of fire or electrical shock, connect the power cord to an appropriately rated and properly grounded electrical outlet that is near the product and easily accessible.

- 8 Turn on the printer.

Installing optional trays

CAUTION—SHOCK HAZARD: To avoid the risk of electrical shock, if you are accessing the controller board or installing optional hardware or memory devices sometime after setting up the printer, then turn the printer off, and unplug the power cord from the electrical outlet before continuing. If you have any other devices attached to the printer, then turn them off as well, and unplug any cables going into the printer.

- 1 Turn off the printer.
- 2 Unplug the power cord from the electrical outlet, and then from the printer.

- 3 Unpack the optional tray, and then remove all packing material.

Note: If optional trays are already installed, then unlock them from the printer before lifting the printer. Do not try to lift the printer and trays at the same time.

- 4 Align the printer with the optional tray, and then lower the printer until it *clicks* into place.

 **CAUTION—POTENTIAL INJURY:** If the printer weight is greater than 20 kg (44 lb), then it may require two or more people to lift it safely.



- 5 Connect the power cord to the printer, and then to the electrical outlet.

 **CAUTION—POTENTIAL INJURY:** To avoid the risk of fire or electrical shock, connect the power cord to an appropriately rated and properly grounded electrical outlet that is near the product and easily accessible.

- 6 Turn on the printer.

Add the tray in the print driver to make it available for print jobs. For more information, see [“Adding available options in the print driver” on page 211](#).

Software

Installing the printer software

Notes:

- The print driver is included in the software installer package.
- For Macintosh computers with macOS version 10.7 or later, you do not need to install the driver to print on an AirPrint-certified printer. If you want custom printing features, then download the print driver.

- 1 Obtain a copy of the software installer package.

- From the software CD that came with your printer.
- Go to www.lexmark.com/downloads.

- 2 Run the installer, and then follow the instructions on the computer screen.

Installing the fax driver

- 1 Go to www.lexmark.com/downloads, search for your printer model, and then download the appropriate installer package.
- 2 From your computer, click **Printer Properties**, and then navigate to the **Configuration** tab.
- 3 Select **Fax**, and then click **Apply**.

Adding printers to a computer

Before you begin, do one of the following:

- Connect the printer and the computer to the same network. For more information on connecting the printer to a network, see [“Connecting the printer to a Wi-Fi network” on page 120](#).
- Connect the computer to the printer. For more information, see [“Connecting a computer to the printer” on page 123](#).
- Connect the printer to the computer using a USB cable. For more information, see [“Attaching cables” on page 14](#).

Note: The USB cable is sold separately.

For Windows users

- 1 From a computer, install the print driver.

Note: For more information, see [“Installing the printer software” on page 209](#).

- 2 Open **Printers & scanners**, and then click **Add a printer or scanner**.
- 3 Depending on your printer connection, do one of the following:
 - Select a printer from the list, and then click **Add device**.
 - Click **Show Wi-Fi Direct printers**, select a printer, and then click **Add device**.
 - Click **The printer that I want isn't listed**, and then from the Add Printer window, do the following:
 - a Select **Add a printer using a TCP/IP address or hostname**, and then click **Next**.
 - b In the “Hostname or IP address” field, type the printer IP address, and then click **Next**.

Notes:

- View the printer IP address on the printer home screen. The IP address appears as four sets of numbers separated by periods, such as 123.123.123.123.
 - If you are using a proxy server, then temporarily disable it to load the web page correctly.
- c Select a print driver, and then click **Next**.
 - d Select **Use the print driver that is currently installed (recommended)**, and then click **Next**.
 - e Type a printer name, and then click **Next**.
 - f Select a printer sharing option, and then click **Next**.
 - g Click **Finish**.

For Macintosh users

- 1 From a computer, open **Printers & Scanners**.
- 2 Click **+**, and then select a printer.
- 3 From the Use menu, select a print driver.

Notes:

- To use the Macintosh print driver, select either **AirPrint** or **Secure AirPrint**.
- If you want custom printing features, then select the Lexmark print driver. To install the driver, see [“Installing the printer software” on page 209](#).

- 4 Add the printer.

Adding available options in the print driver

For Windows users

- 1 Open the printers folder.
- 2 Select the printer you want to update, and then do either of the following:
 - For Windows 7 or later, select **Printer properties**.
 - For earlier versions, select **Properties**.
- 3 Navigate to the Configuration tab, and then select **Update Now - Ask Printer**.
- 4 Apply the changes.

For Macintosh users

- 1 From System Preferences in the Apple menu, navigate to your printer, and then select **Options & Supplies**.
- 2 Navigate to the list of hardware options, and then add any installed options.
- 3 Apply the changes.

Firmware

Exporting or importing a configuration file

You can export the configuration settings of your printer into a text file, and then import the file to apply the settings to other printers.

- 1 Open a web browser, and then type the printer IP address in the address field.

Notes:

- View the printer IP address on the printer home screen. The IP address appears as four sets of numbers separated by periods, such as 123.123.123.123.
- If you are using a proxy server, then temporarily disable it to load the web page correctly.

- 2 From the Embedded Web Server, click **Export Configuration** or **Import Configuration**.

- 3 Follow the instructions on the screen.
- 4 If the printer supports applications, then do the following:
 - a Click **Apps** > select the application > **Configure**.
 - b Click **Export** or **Import**.

Updating firmware

Updating the firmware using the control panel

Using the notification center

This method is applicable only in some printer models.

- 1 From the control panel, navigate to the notification center, and then select **Firmware update available**.

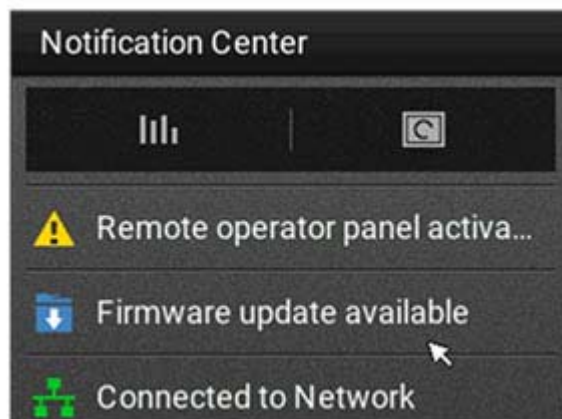

- 2 Select **Install now**.



The printer reboots automatically after the update.

Using the Settings menu

- 1 From the control panel, navigate to **Settings** > **Device** > **Update Firmware**.
- 2 Depending on your printer model, select **Check for updates** or **Check for updates now**.

3 If a new update is available, then select **Install now**.

The printer reboots automatically after the update.

Updating the firmware using the Embedded Web Server

Before you begin, make sure that:

- You have downloaded the latest printer firmware from <https://support.lexmark.com> and saved it to your flash drive or computer.

Note: To deploy the printer firmware, extract the .fls firmware file from the ZIP package.

- You are not using a special code on your printer to avoid losing this functionality.

Warning—Potential Damage: Make sure that all printers receiving firmware updates are turned on during the entire firmware update process. Turning off a printer during a firmware update can severely damage it.

If the printer is connected to the network when checking for updates, then downloading the firmware is not required.

1 Open a web browser, and then type the printer IP address in the address field.

Notes:

- View the printer IP address on the printer home screen. The IP address appears as four sets of numbers separated by periods, such as 123.123.123.123.
- If you are using a proxy server, then temporarily disable it to load the web page correctly.

2 Click **Device**.

3 Scroll down, and then click **Update Firmware**.

4 Depending on your printer model, click **Check for updates** or **Check for updates now**.

If a new update is available, then click **I agree, start update**.

The printer reboots automatically after the update.

Notices

Product information

Product name:

Lexmark MB2338adw; Lexmark MX321adn, Lexmark MX321adw MFPs

Machine type:

7017

Models:

276, 278

Edition notice

March 2024

The following paragraph does not apply to any country where such provisions are inconsistent with local law: LEXMARK INTERNATIONAL, INC., PROVIDES THIS PUBLICATION "AS IS" WITHOUT WARRANTY OF ANY KIND, EITHER EXPRESS OR IMPLIED, INCLUDING, BUT NOT LIMITED TO, THE IMPLIED WARRANTIES OF MERCHANTABILITY OR FITNESS FOR A PARTICULAR PURPOSE. Some states do not allow disclaimer of express or implied warranties in certain transactions; therefore, this statement may not apply to you.

This publication could include technical inaccuracies or typographical errors. Changes are periodically made to the information herein; these changes will be incorporated in later editions. Improvements or changes in the products or the programs described may be made at any time.

References in this publication to products, programs, or services do not imply that the manufacturer intends to make these available in all countries in which it operates. Any reference to a product, program, or service is not intended to state or imply that only that product, program, or service may be used. Any functionally equivalent product, program, or service that does not infringe any existing intellectual property right may be used instead. Evaluation and verification of operation in conjunction with other products, programs, or services, except those expressly designated by the manufacturer, are the user's responsibility.

For Lexmark technical support, visit <http://support.lexmark.com>.

For information on supplies and downloads, visit www.lexmark.com.

© 2018 Lexmark International, Inc.

All rights reserved.

GOVERNMENT END USERS

The Software Program and any related documentation are "Commercial Items," as that term is defined in 48 C.F.R. 2.101, "Computer Software" and "Commercial Computer Software Documentation," as such terms are used in 48 C.F.R. 12.212 or 48 C.F.R. 227.7202, as applicable. Consistent with 48 C.F.R. 12.212 or 48 C.F.R. 227.7202-1 through 227.7207-4, as applicable, the Commercial Computer Software and Commercial Software Documentation are licensed to the U.S. Government end users (a) only as Commercial Items and (b) with only those rights as are granted to all other end users pursuant to the terms and conditions herein.

Trademarks

Lexmark, the Lexmark logo, and MarkNet are trademarks or registered trademarks of Lexmark International, Inc. in the United States and/or other countries.

Gmail, Android, Google Play, and Google Chrome are trademarks of Google LLC.

Macintosh, Safari, and AirPrint are trademarks of Apple Inc., registered in the U.S. and other countries. App Store and iCloud are service marks of Apple Inc., registered in the U.S. and other countries. Use of the Works with Apple badge means that an accessory has been designed to work specifically with the technology identified in the badge and has been certified by the developer to meet Apple performance standards.

The Mopria® word mark is a registered and/or unregistered trademark of Mopria Alliance, Inc. in the United States and other countries. Unauthorized use is strictly prohibited.

PCL® is a registered trademark of the Hewlett-Packard Company. PCL is Hewlett-Packard Company’s designation of a set of printer commands (language) and functions included in its printer products. This printer is intended to be compatible with the PCL language. This means the printer recognizes PCL commands used in various application programs, and that the printer emulates the functions corresponding to the commands.

PostScript is a registered trademark of Adobe Systems Incorporated in the United States and/or other countries.

Wi-Fi® and Wi-Fi Direct® are registered trademarks of Wi-Fi Alliance®.

All other trademarks are the property of their respective owners.

Licensing notices

All licensing notices associated with this product can be viewed from the CD:\NOTICES directory of the installation software CD.

Noise emission levels

The following measurements were made in accordance with ISO 7779 and reported in conformance with ISO 9296.

Note: Some modes may not apply to your product.

1-meter average sound pressure, dBA	
Printing	One-sided: 54 Two-sided: 53
Scanning	54
Copying	54
Ready	14

Values are subject to change. See www.lexmark.com for current values.

Waste from Electrical and Electronic Equipment (WEEE) directive



The WEEE logo signifies specific recycling programs and procedures for electronic products in countries of the European Union. We encourage the recycling of our products.

If you have further questions about recycling options, visit the Lexmark Web site at www.lexmark.com for your local sales office phone number.

India E-Waste notice



This product including components, consumables, parts and spares complies with the “India E-Waste Rules” and prohibits use of lead, mercury, hexavalent chromium, polybrominated biphenyls or polybrominated diphenyl ethers in concentrations exceeding 0.1% by weight and 0.01% by weight for cadmium, except for the exemption set in the Rule.

Product disposal

Do not dispose of the printer or supplies in the same manner as normal household waste. Consult your local authorities for disposal and recycling options.

EU battery directive

This product may contain a coin-cell lithium rechargeable battery. This product is in compliance with EU Directive 2006/66/EC as amended by Directive 2008/12/EC, 2008/103/EC, and 2013/56/EU.

Returning Lexmark cartridges for reuse or recycling

The Lexmark Cartridge Collection Program allows you to return used cartridges for free to Lexmark for reuse or recycling. One hundred percent of the empty cartridges returned to Lexmark are either reused or demanufactured for recycling. The boxes used to return the cartridges are also recycled.

To return Lexmark cartridges for reuse or recycling, do the following:

- 1 Go to www.lexmark.com/recycle.
- 2 Select the product that you want to recycle.

Static sensitivity notice



This symbol identifies static-sensitive parts. Do not touch the areas near these symbols without first touching a metal surface in an area away from the symbol.

To prevent damage from electrostatic discharge when performing maintenance tasks such as clearing paper jams or replacing supplies, touch any exposed metal frame of the printer before accessing or touching interior areas of the printer even if the symbol is not present.

ENERGY STAR

Any Lexmark product bearing the ENERGY STAR® emblem on the product or on a start-up screen is certified to comply with Environmental Protection Agency (EPA) ENERGY STAR requirements as of the date of manufacture.



Temperature information

Ambient operating temperature	10 to 32°C (50 to 90°F)
Shipping temperature	-20 to 40°C (-4 to 104°F)
Storage temperature and relative humidity	0 to 40°C (32 to 104°F) 8 to 80% RH

Laser notice

The printer is certified in the U.S. to conform to the requirements of DHHS 21 CFR, Chapter I, Subchapter J for Class I (1) laser products, and elsewhere is certified as a Class I laser product conforming to the requirements of IEC 60825-1: 2014.

Class I laser products are not considered to be hazardous. The laser system and printer are designed so there is never any human access to laser radiation above a Class I level during normal operation, user maintenance,

or prescribed service conditions. The printer has a non-serviceable printhead assembly that contains a laser with the following specifications:

Class: IIIb (3b) AlGaInP

Nominal output power (milliwatts): 15

Wavelength (nanometers): 650–670

Power consumption

Product power consumption

The following table documents the power consumption characteristics of the product.

Note: Some modes may not apply to your product.

Mode	Description	Power consumption (Watts)
Printing	The product is generating hard-copy output from electronic inputs.	One-sided: 520 Two-sided: 325
Copy	The product is generating hard-copy output from hard-copy original documents.	550
Scan	The product is scanning hard-copy documents.	14.5
Ready	The product is waiting for a print job.	10.5
Sleep Mode	The product is in a high-level energy-saving mode.	1.3
Hibernate	The product is in a low-level energy-saving mode.	0.1
Off	The product is plugged into an electrical outlet, but the power switch is turned off.	0.1

The power consumption levels listed in the previous table represent time-averaged measurements. Instantaneous power draws may be substantially higher than the average.

Values are subject to change. See www.lexmark.com for current values.

Sleep Mode

This product is designed with an energy-saving mode called *Sleep Mode*. The Sleep Mode saves energy by lowering power consumption during extended periods of inactivity. The Sleep Mode is automatically engaged after this product is not used for a specified period of time, called the *Sleep Mode Timeout*.

Factory default Sleep Mode Timeout for this product (in minutes):	15
---	----

By using the configuration menus, the Sleep Mode Timeout can be modified between 1 minute and 120 minutes. If the print speed is less than or equal to 30 pages per minute, then you can set the timeout only up to 60 minutes. Setting the Sleep Mode Timeout to a low value reduces energy consumption, but may increase the response time of the product. Setting the Sleep Mode Timeout to a high value maintains a fast response, but uses more energy.

Hibernate Mode

This product is designed with an ultra-low power operating mode called *Hibernate mode*. When operating in Hibernate Mode, all other systems and devices are powered down safely.

The Hibernate mode can be entered in any of the following methods:

- Using the Hibernate Timeout
- Using the Schedule Power modes

Factory default Hibernate Timeout for this product in all countries or regions	3 days
--	--------

The amount of time the printer waits after a job is printed before it enters Hibernate mode can be modified between one hour and one month.

Notes on EPEAT-registered imaging equipment products:

- Standby power level occurs in Hibernate or Off mode.
- The product shall automatically power down to a standby power level of ≤ 1 W. The auto standby function (Hibernate or Off) shall be enabled at product shipment.

Off mode

If this product has an off mode which still consumes a small amount of power, then to completely stop product power consumption, disconnect the power supply cord from the electrical outlet.

Total energy usage

It is sometimes helpful to estimate the total product energy usage. Since power consumption claims are provided in power units of Watts, the power consumption should be multiplied by the time the product spends in each mode in order to calculate energy usage. The total product energy usage is the sum of each mode's energy usage.

Applicability of Regulation (EU) 2019/2015 and (EU) 2019/2020

Per Commission Regulation (EU) 2019/2015 and (EU) 2019/2020, the light source contained within this product or its component is intended to be used for Image Capture or Image Projection only, and is not intended for use in other applications.

The UK Product Security and Telecommunications Infrastructure Act 2022 (PSTI Act)—Summary Statement of Compliance

Lexmark International Inc., 740 West New Circle Road, Lexington, KY 40550 USA, declares that this product complies with the applicable security requirements in Schedule 1 of The Product Security and Telecommunications Infrastructure (Security Requirements for Relevant Connectable Products) Regulations 2023. The defined support period for this product can be found at the following web page: <https://www.lexmark.com/firmware-eos>.

A copy of the Statement of Compliance is available for download at the following web page: https://www.lexmark.com/en_us/about/regulatory-compliance/all-regulatory-docs.html.

Regulatory notices for telecommunication terminal equipment

This section contains regulatory information pertaining to products that contain the analog facsimile card:

Lexmark Regulatory Type/Model Number:

LEX-M14-002 or LEX-M03-002

Notice to users of the US telephone network: FCC requirements

This equipment complies with Part 68 of the FCC rules and the requirements adopted by the Administrative Council for Terminal Attachments (ACTA). On the back of this equipment is a label that contains, among other information, a product identifier in the format US:AAAEQ##TXXXX. If requested, this number must be provided to your telephone company.

This equipment uses the RJ-11C Universal Service Order Code (USOC) jack.

A plug and jack used to connect this equipment to the premises' wiring and telephone network must comply with the applicable FCC Part 68 rules and requirements adopted by the ACTA. Use a compliant telephone cord (RJ-11) that is 26 AWG or larger when connecting this product to the public switched telephone network. See your setup documentation for more information.

The Ringer Equivalence Number (REN) is used to determine the number of devices that may be connected to a telephone line. Excessive RENs on a telephone line may result in the devices not ringing in response to an incoming call. In most but not all areas, the sum of RENs should not exceed five (5.0). To be certain of the number of devices that may be connected to a line, as determined by the total RENs, contact your local telephone company. For products approved after July 23, 2001, the REN for this product is part of the product identifier that has the format US:AAAEQ##TXXXX. The digits represented by ## are the REN without a decimal point (for example, 03 is a REN of 0.3). For earlier products, the REN is shown separately on the label.

If this equipment causes harm to the telephone network, the telephone company will notify you in advance that temporary discontinuance of service may be required. If advance notice is not practical, the telephone company will notify the customer as soon as possible. You will also be advised of your right to file a complaint with the FCC.

The telephone company may make changes in its facilities, equipment, operations or procedures that could affect the operation of this equipment. If this happens, the telephone company will provide advance notice in order for you to make necessary modifications to maintain uninterrupted service.

If you experience trouble with this equipment, for repair or warranty information, contact Lexmark International, Inc. at www.lexmark.com or your Lexmark representative. If the equipment is causing harm to the telephone network, the telephone company may request that you disconnect the equipment until the problem is resolved.

This equipment contains no user serviceable parts. For repair and warranty information, contact Lexmark International, Inc. See the previous paragraph for contact information.

Connection to party line service is subject to state tariffs. Contact the state public utility commission, public service commission, or corporation commission for information.

If your home has specially wired alarm equipment connected to the telephone line, ensure the installation of this equipment does not disable your alarm equipment. If you have questions about what will disable alarm equipment, consult your telephone company or a qualified installer.

The Telephone Consumer Protection Act of 1991 makes it unlawful for any person to use a computer or other electronic device, including fax machines, to send any message unless said message clearly contains in a margin at the top or bottom of each transmitted page or on the first page of the transmission, the date and time it is sent and an identification of the business or other entity, or other individual sending the message, and the

telephone number of the sending machine or such business, other entity, or individual. (The telephone number provided may not be a 900 number or any other number for which charges exceed local or long-distance transmission charges.)

See your user documentation in order to program this information into your fax machine.

Notice to users of the Canadian telephone network

This product meets the applicable Innovation, Science and Economic Development Canada technical specifications.

The Ringer Equivalence Number (REN) indicates the maximum number of devices allowed to be connected to a telephone interface. The termination of an interface may consist of any combination of devices subject only to the requirement that the sum of the RENs of all the devices not exceed five. The REN is located on the product label.

This equipment uses CA11A telephone jacks.

Avis réservé aux utilisateurs du réseau téléphonique du Canada

Ce produit est conforme aux spécifications techniques d'Innovation, Sciences et Développement économique Canada.

Le numéro REN (ringer equivalence number : numéro d'équivalence de sonnerie) indique le nombre maximum d'appareils pouvant être connectés à l'interface téléphonique. En bout de ligne, le nombre d'appareils qui peuvent être connectés n'est pas directement limité, mais la somme des REN de ces appareils ne doit pas dépasser cinq. Le numéro REN est indiqué sur l'étiquette produit.

Cet équipement utilise des prises de téléphone CA11A.

Notice to users of the New Zealand telephone network

The following are special conditions for the Facsimile User Instructions. The grant of a telepermit for any item of terminal equipment indicates only that Telecom has accepted that the item complies with minimum conditions for connection to its network. It indicates no endorsement of the product by Telecom, nor does it provide any sort of warranty. Above all, it provides no assurance that any item will work correctly in all respects with another item of telepermitted equipment of a different make or model, nor does it imply that any product is compatible with all of Telecom's network services.

This equipment shall not be set up to make automatic calls to the Telecom "111" Emergency Service.

This equipment may not provide for the effective hand-over of a call to another device connected to the same line.

This equipment should not be used under any circumstances that may constitute a nuisance to other Telecom customers.

This equipment is not capable, under all operating conditions, of correct operation at the higher speeds for which it is designed. Telecom will accept no responsibility should difficulties arise in such circumstances.

The decadic (or pulse) dialing on this device is unsuitable for use on the Telecom network in New Zealand.

For correct operation, the total of all the Ringer Equivalence Numbers (RENs) of all parallel devices connected to the same telephone line may not exceed 5. The REN of this device is located on the label.

This device uses an RJ-11C modular connector. Contact your point of purchase if a BT adapter is required. The Lexmark part number is 80D1873.

Some parameters required for compliance with Telecom's telepermit requirements are dependent on the equipment associated with this device. The associated equipment shall be set to operate within the following limits for compliance to Telecom's specifications:

- There shall be no more than 10 call attempts to the same number within any 30 minute period for any single manual call initiation, and
- The equipment shall go on-hook for a period of not less than 30 seconds between the end of one attempt and the beginning of the next call attempt.
- The equipment shall be set to ensure that automatic calls to different numbers are spaced such that there is not less than 5 seconds between the end of one call attempt and the beginning of another.

Japanese telecom notice

The installed optional modem is in compliance with Japanese Telecommunication Law and has been Certified by JATE, with the following Certification Number:

A18-0046001 or A11-0160001

	Lexmark International, Inc.
	LEX-M14-002 or LEX-M03-002
	A18-0046001 or A11-0160001

Using this product in Switzerland

This product requires a Swiss billing tone filter (Lexmark part number 80D1877) to be installed on any line which receives metering pulses in Switzerland.

Utilisation de ce produit en Suisse

Cet appareil nécessite l'utilisation d'un filtre de tonalité de facturation suisse (n° de référence Lexmark : 80D1877) devant être installé sur toute ligne recevant des impulsions de comptage en Suisse.

Verwendung dieses Produkts in der Schweiz

Für dieses Produkt muss ein schweizerischer Billing Tone Filter zur Zählzeichenübertragung (Lexmark Teilenummer 80D1877) für jede Leitung installiert werden, über die in der Schweiz Zeitsteuertakte übertragen werden.

Usò del prodotto in Svizzera

Questo prodotto richiede un filtro toni Billing svizzero, (codice Lexmark 80D1877) da installare su tutte le linee che ricevono impulsi remoti in Svizzera.

Regulatory notices for wireless products

This section contains regulatory information that applies only to wireless models.

If in doubt as to whether your model is a wireless model, go to <http://support.lexmark.com>.

Modular component notice

Wireless models contain one of the following modular components:

Lexmark Regulatory Type/Model Number LEX-M07-001; FCC ID:IYLLLEXM07001; Industry Canada IC:2376A-LEXM07001

Lexmark Regulatory Type/Model Number LEX-M08-001; FCC ID:IYLLLEXM08001; IC:2376A-LEXM08001

To determine which modular components are installed in your particular product, refer to the labeling on your actual product.

Exposure to radio frequency radiation

The radiated output power of this device is far below the radio frequency exposure limits of the FCC and other regulatory agencies. A minimum separation of 20 cm (8 inches) must be maintained between the antenna and any persons for this device to satisfy the RF exposure requirements of the FCC and other regulatory agencies.

Innovation, Science and Economic Development Canada

This device complies with Innovation, Science and Economic Development Canada license-exempt RSS standards. Operation is subject to the following two conditions: (1) this device may not cause interference, and (2) this device must accept any interference, including interference that may cause undesired operation of the device.

Innovation, Sciences et Développement économique Canada

Cet appareil est conforme aux normes RSS exemptes de licence d'Innovation, Sciences et Développement économique Canada. Son fonctionnement est soumis aux deux conditions suivantes : (1) cet appareil ne doit pas causer d'interférences et (2) il doit accepter toutes les interférences, y compris les celles qui peuvent entraîner un fonctionnement indésirable.

European Community (EC) directives conformity

This product is in conformity with the protection requirements of EC Council directive 2014/53/EU on the approximation and harmonization of the laws of the Member States relating to radio equipment.

The manufacturer of this product is: Lexmark International, Inc., 740 West New Circle Road, Lexington, KY, 40550 USA. The EEA/EU authorized representative is: Lexmark International Technology Hungária Kft., 8

Lechner Ödön fasor, Millennium Tower III, 1095 Budapest HUNGARY. The EEA/EU Importer is: Lexmark International Technology S.à.r.l. 20, Route de Pré-Bois, ICC Building, Bloc A, CH-1215 Genève, Switzerland. A declaration of conformity to the requirements of the Directives is available upon request from the Authorized Representative or may be obtained at www.lexmark.com/en_us/about/regulatory-compliance/european-union-declaration-of-conformity.html.

Compliance is indicated by the CE marking:



Restrictions

This radio equipment is restricted to indoor use only. Outdoor use is prohibited. This restriction applies to all the countries listed in the table below:



AT	BE	BG	CH	CY	CZ	DE	DK	EE
EL	ES	FI	FR	HR	HU	IE	IS	IT
LI	LT	LU	LV	MT	NL	NO	PL	PT
RO	SE	SI	SK	TR	UK (NI)			

EU and other countries statement of radio transmitter operational frequency bands and maximum RF power

This radio product transmits in either the 2.4GHz (2.412–2.472 GHz in the EU) or 5GHz (5.15–5.35, 5.47–5.725 in the EU) bands. The maximum transmitter EIRP power output, including antenna gain, is ≤ 20dBm for both bands.

United Kingdom (UK) conformity

This product is in conformity with the protection requirements of the Radio Equipment Regulations 2017.

The manufacturer of this product is: Lexmark International, Inc., 740 West New Circle Road, Lexington, KY, 40550 USA. The UK Importer is: Lexmark International Ltd, Highfield House, Foundation Park - 8 Roxborough Way, Maidenhead Berkshire - SL6 3UD, United Kingdom. A declaration of conformity is available upon request from the UK Importer or may be obtained at www.lexmark.com/en_us/about/regulatory-compliance/uk-declaration-of-conformity.html.

Compliance is indicated by the UKCA marking:



Restrictions or requirements in the UK

This radio equipment is restricted to indoor use only. Outdoor use is prohibited.

UK statement of radio transmitter operational frequency bands and maximum RF power

This radio product transmits in either the 2.4GHz (2.412–2.472 GHz in the UK) or 5GHz (5.15–5.35, 5.47–5.725 in the UK) bands. The maximum transmitter EIRP power output, including antenna gain, is $\leq 20\text{dBm}$ for both bands.

Federal Communications Commission (FCC) compliance information statement

This product has been tested and found to comply with the limits for a Class B digital device, pursuant to Part 15 of the FCC Rules. Operation is subject to the following two conditions: (1) this device may not cause harmful interference, and (2) this device must accept any interference received, including interference that may cause undesired operation.

The FCC Class B limits are designed to provide reasonable protection against harmful interference when the equipment is operated in a residential installation. This equipment generates, uses, and can radiate radio frequency energy and, if not installed and used in accordance with the instructions, may cause harmful interference to radio communications. However, there is no guarantee that interference will not occur in a particular installation. If this equipment does cause harmful interference to radio or television reception, which can be determined by turning the equipment off and on, the user is encouraged to try to correct the interference by one or more of the following measures:

- Reorient or relocate the receiving antenna.
- Increase the separation between the equipment and receiver.
- Connect the equipment into an outlet on a circuit different from that to which the receiver is connected.
- Consult your point of purchase or service representative for additional suggestions.

The manufacturer is not responsible for radio or television interference caused by using other than recommended cables or by unauthorized changes or modifications to this equipment. Unauthorized changes or modifications could void the user's authority to operate this equipment.

Note: To assure compliance with FCC regulations on electromagnetic interference for a Class B computing device, use a properly shielded and grounded cable such as Lexmark part number 1021231 for parallel attach or 1021294 for USB attach. Use of a substitute cable not properly shielded and grounded may result in a violation of FCC regulations.

Any questions regarding this compliance information statement should be directed to:

Director of Lexmark Technology & Services
Lexmark International, Inc.
740 West New Circle Road
Lexington, KY 40550
Telephone: (859) 232-2000
E-mail: regulatory@lexmark.com

Innovation, Science and Economic Development Canada compliance statement

This Class B digital apparatus meets all requirements of the Canadian Interference-Causing Equipment Standard ICES-003.

Avis de conformité aux normes de l'Innovation, Sciences et Développement économique Canada

Cet appareil numérique de classe B est conforme aux exigences de la norme canadienne relative aux équipements pouvant causer des interférences NMB-003.

日本の VCCI 規定

製品にこのマークが表示されている場合、次の要件を満たしています。



この装置は、クラス B 情報技術装置です。この装置は、家庭環境で使用することを目的としていますが、この装置がラジオやテレビジョン受信機に近接して使用されると、受信障害を引き起こすことがあります。

取扱説明書に従って正しい取り扱いをしてください。

VCCI-B

European Community (EC) directives conformity

This product is in conformity with the protection requirements of EC Council directives 2014/30/EU, 2014/35/EU, 2009/125/EC, and 2011/65/EU as amended by (EU) 2015/863 on the approximation and harmonization of the laws of the Member States relating to electromagnetic compatibility, safety of electrical equipment designed for use within certain voltage limits, the ecodesign of energy-related products, and on the restrictions of use of certain hazardous substances in electrical and electronic equipment.

The manufacturer of this product is: Lexmark International, Inc., 740 West New Circle Road, Lexington, KY, 40550 USA. The EEA/EU authorized representative is: Lexmark International Technology Hungária Kft., 8 Lechner Ödön fasor, Millennium Tower III, 1095 Budapest HUNGARY. The EEA/EU Importer is: Lexmark International Technology S.à.r.l. 20, Route de Pré-Bois, ICC Building, Bloc A, CH-1215 Genève, Switzerland. A declaration of conformity to the requirements of the Directives is available upon request from the Authorized

Representative or may be obtained at

www.lexmark.com/en_us/about/regulatory-compliance/european-union-declaration-of-conformity.html.

This product satisfies the Class B limits of EN 55032 and safety requirements of EN 62368-1.

STATEMENT OF LIMITED WARRANTY FOR LEXMARK LASER PRINTERS, LEXMARK LED PRINTERS, AND LEXMARK MULTIFUNCTION LASER PRINTERS

Lexmark International, Inc., Lexington, KY

This limited warranty applies to the United States and Canada. For customers outside the U.S., refer to the country-specific warranty information that came with your product.

This limited warranty applies to this product only if it was originally purchased for your use, and not for resale, from Lexmark or a Lexmark Remarketer, referred to in this statement as “Remarketer.”

Limited warranty

Lexmark warrants that this product:

- Is manufactured from new parts, or new and serviceable used parts, which perform like new parts
- Is, during normal use, free from defects in material and workmanship

If this product does not function as warranted during the warranty period, contact a Remarketer or Lexmark for repair or replacement (at Lexmark's option).

If this product is a feature or option, this statement applies only when that feature or option is used with the product for which it was intended. To obtain warranty service, you may be required to present the feature or option with the product.

If you transfer this product to another user, warranty service under the terms of this statement is available to that user for the remainder of the warranty period. You should transfer proof of original purchase and this statement to that user.

Limited warranty service

The warranty period starts on the date of original purchase as shown on the purchase receipt and ends 12 months later provided that the warranty period for any supplies and for any maintenance items included with the printer shall end earlier if it, or its original contents, are substantially used up, depleted, or consumed. Fuser Units, Transfer/Transport Units, Paper Feed items, if any, and any other items for which a Maintenance Kit is available are substantially consumed when the printer displays a “Life Warning” or “Scheduled Maintenance” message for such item.

To obtain warranty service you may be required to present proof of original purchase. You may be required to deliver your product to the Remarketer or Lexmark, or ship it prepaid and suitably packaged to a Lexmark designated location. You are responsible for loss of, or damage to, a product in transit to the Remarketer or the Lexmark designated location.

When warranty service involves the exchange of a product or part, the item replaced becomes the property of the Remarketer or Lexmark. The replacement may be a new or repaired item.

The replacement item assumes the remaining warranty period of the original product.

Replacement is not available to you if the product you present for exchange is defaced, altered, in need of a repair not included in warranty service, damaged beyond repair, or if the product is not free of all legal obligations, restrictions, liens, and encumbrances.

As part of your warranty service and/or replacement, Lexmark may update the firmware in your printer to the latest version. Firmware updates may modify printer settings and cause counterfeit and/or unauthorized products, supplies, parts, materials (such as toners and inks), software, or interfaces to stop working. Authorized use of genuine Lexmark products will not be impacted.

Before you present this product for warranty service, remove all print cartridges, programs, data, and removable storage media (unless directed otherwise by Lexmark).

For further explanation of your warranty alternatives and the nearest Lexmark authorized servicer in your area contact Lexmark on the World Wide Web.

Remote technical support is provided for this product throughout its warranty period. For products no longer covered by a Lexmark warranty, technical support may not be available or only be available for a fee.

Extent of limited warranty

Lexmark does not warrant uninterrupted or error-free operation of any product or the durability or longevity of prints produced by any product.

Warranty service does not include repair of failures caused by:

- Modification or unauthorized attachments
- Accidents, misuse, abuse or use inconsistent with Lexmark user's guides, manuals, instructions or guidance
- Unsuitable physical or operating environment
- Maintenance by anyone other than Lexmark or a Lexmark authorized servicer
- Operation of a product beyond the limit of its duty cycle
- Use of printing media outside of Lexmark specifications
- Refurbishment, repair, refilling or remanufacture by a third party of products, supplies or parts
- Products, supplies, parts, materials (such as toners and inks), software, or interfaces not furnished by Lexmark

TO THE EXTENT PERMITTED BY APPLICABLE LAW, NEITHER LEXMARK NOR ITS THIRD PARTY SUPPLIERS OR REMARKETERS MAKE ANY OTHER WARRANTY OR CONDITION OF ANY KIND, WHETHER EXPRESS OR IMPLIED, WITH RESPECT TO THIS PRODUCT, AND SPECIFICALLY DISCLAIM THE IMPLIED WARRANTIES OR CONDITIONS OF MERCHANTABILITY, FITNESS FOR A PARTICULAR PURPOSE, AND SATISFACTORY QUALITY. ANY WARRANTIES THAT MAY NOT BE DISCLAIMED UNDER APPLICABLE LAW ARE LIMITED IN DURATION TO THE WARRANTY PERIOD. NO WARRANTIES, EXPRESS OR IMPLIED, WILL APPLY AFTER THIS PERIOD. ALL INFORMATION, SPECIFICATIONS, PRICES, AND SERVICES ARE SUBJECT TO CHANGE AT ANY TIME WITHOUT NOTICE.

Limitation of liability

Your sole remedy under this limited warranty is set forth in this document. For any claim concerning performance or nonperformance of Lexmark or a Remarketer for this product under this limited warranty, you may recover actual damages up to the limit set forth in the following paragraph.

Lexmark's liability for actual damages from any cause whatsoever will be limited to the amount you paid for the product that caused the damages. This limitation of liability will not apply to claims by you for bodily injury or damage to real property or tangible personal property for which Lexmark is legally liable. **IN NO EVENT WILL**

LEXMARK BE LIABLE FOR ANY LOST PROFITS, LOST SAVINGS, INCIDENTAL DAMAGE, OR OTHER ECONOMIC OR CONSEQUENTIAL DAMAGES. This is true even if you advise Lexmark or a Remarketer of the possibility of such damages. Lexmark is not liable for any claim by you based on a third party claim.

This limitation of remedies also applies to claims against any Suppliers and Remarketers of Lexmark. Lexmark's and its Suppliers' and Remarketers' limitations of remedies are not cumulative. Such Suppliers and Remarketers are intended beneficiaries of this limitation.

Additional rights

Some states do not allow limitations on how long an implied warranty lasts, or do not allow the exclusion or limitation of incidental or consequential damages, so the limitations or exclusions contained above may not apply to you.

This limited warranty gives you specific legal rights. You may also have other rights that vary from state to state.

Index

A

- adapter plug 42
- adding hardware options
 - print driver 211
- adding internal options
 - print driver 211
- adding printers to a computer 210
- ADF registration
 - adjusting 203
- ADF separator roller
 - replacing 139
- adjusting
 - scanner registration 202
- adjusting ADF registration 203
- adjusting fax darkness 47
- adjusting toner darkness 185
- AirPrint
 - using 24
- analog fax
 - setting up 39
- answering machine
 - setting up 40
- assigning printer to a ring pattern 44
- attaching cables 14
- automatic document feeder (ADF)
 - using 26, 29, 45, 50
- avoiding paper jams 144

B

- blank pages 157
- blocking junk faxes 48

C

- cables
 - Ethernet 14
 - USB 14
- can send but not receive faxes using analog fax 197
- cannot open Embedded Web Server 185
- cannot send e-mails 192
- cannot send or receive faxes using analog fax 194

- cannot send or receive faxes using etherFAX 196
- cannot send the fax cover page from the computer 198
- changing resolution
 - fax 47
- checking the printer connectivity 186
- checking the status of parts and supplies 126
- cleaning
 - exterior of the printer 123
 - interior of the printer 123
- cleaning the printer 123
- cleaning the scanner 117, 124
- clearing jam
 - in door A 146
- collated printing does not work 190
- collating copies 27
- computer
 - connecting to the printer 123
- computer, scanning to 50
- configuring daylight saving time 45
- configuring supply notifications 128
- configuring the e-mail server settings 29
- configuring Universal paper settings 17
- configuring Wi-Fi Direct 122
- connecting a computer to the printer 123
- connecting mobile device to printer 122
- connecting printer to distinctive ring service 44
- connecting the printer to a wireless network 120
- connecting to a wireless network
 - using PIN method 121
 - using Push Button method 121
- conserving supplies 143
- contacting customer support 203
- control panel
 - using 15

- copy troubleshooting
 - partial copies of documents or photos 199
 - poor copy quality 200
 - scanner does not respond 202
- copying
 - creating a shortcut 28
 - on both sides of the paper 27
 - on letterhead 27
 - using the automatic document feeder (ADF) 26
 - using the scanner glass 26
- copying different paper sizes 26
- copying multiple pages 28
- copying multiple pages onto a single sheet 28
- copying photos 26
- creating a copy shortcut 28
- creating a fax destination shortcut 47
- creating a shortcut
 - copy 28
 - e-mail 37
 - fax destination 47
 - FTP address 51
 - network folder 52
- creating an e-mail shortcut 37
- creating an FTP shortcut 51
- crooked print 169
- customer support
 - contacting 203

D

- dark print 158
- date and time
 - fax settings 45
- daylight saving time
 - configuring 45
- deactivating the Wi-Fi network 123
- different paper sizes, copying 26
- distinctive ring service, fax
 - enabling 44
- documents, printing
 - from a computer 24
 - from a mobile device 24
- dots on print 167

E

- emission notices 215, 223, 226
- enabling the USB port 186
- enabling Wi-Fi Direct 122
- enlarging a copy 27
- environmental settings 142
- erasing printer memory 118
- etherFAX
 - setting up fax function 40
- Ethernet port 14
- exporting a configuration file
 - using the Embedded Web Server 211
- e-mail
 - creating a shortcut 37
 - sending 37
- e-mail function
 - setting up 29
- e-mail server
 - configuring 29
- e-mail service providers 29
- e-mail troubleshooting
 - cannot send e-mails 192
- e-mailing
 - using the automatic document feeder (ADF) 29
 - using the scanner glass 29

F

- fax
 - forwarding 48
 - holding 48
 - scheduling 46
 - sending 45
- fax darkness
 - adjusting 47
- fax driver
 - installing 210
- fax log
 - printing 47
- fax port 14
- fax resolution
 - changing 47
- fax setup
 - country- or region-specific 42
 - standard telephone line connection 40
- fax troubleshooting
 - caller ID is not shown 193
 - cannot receive faxes using analog fax 197

- cannot send faxes using analog fax 196
- cannot send or receive faxes
 - using analog fax 194
- cannot send or receive faxes
 - using etherFAX 196
- cannot send the fax cover page
 - from the computer 198
- cannot set up etherFAX 193
- missing information on the fax cover page 198
- received fax has poor print quality 197
- faxing
 - creating a shortcut 47
 - setting the date and time 45
 - using the automatic document feeder (ADF) 45
 - using the scanner glass 45
- FCC notices 223
- finding information about the printer 10
- fine lines are not printed correctly 160
- firmware, updating
 - using Embedded Web Server 213
 - using the control panel 212
- folder paper 161
- font sample list
 - printing 25
- forwarding fax 48
- FTP address
 - creating a shortcut 51
- FTP server
 - scanning to 52

G

- genuine Lexmark parts and supplies 127
- gray background on prints 162

H

- hardware options
 - trays 208
- hardware options, adding
 - print driver 211
- Help menu 116
- Hibernate mode
 - setting 142
- holding faxes 48

- HTTP/FTP Settings menu 107

I

- identifying jam locations 145
- imaging unit
 - ordering 128
 - replacing 131
- importing a configuration file
 - using the Embedded Web Server 211
- incorrect margins 164
- indicator light
 - understanding the status 16
- installing a memory card 204
- installing an optional card 206
- installing the fax driver 210
- installing the print driver 209
- installing the printer software 209
- internal option is not detected 187
- internal options
 - font cards 204
 - installing 206
 - memory card 204
 - user flash 204
- internal options, adding
 - print driver 211

J

- jammed pages are not reprinted 192
- jams
 - avoiding 144
- jams, clearing
 - in the automatic document feeder 154
 - in the duplex unit 152
 - in the multipurpose feeder 153
 - in the standard bin 151
 - trays 153
- junk faxes
 - blocking 48

L

- letterhead
 - copying on 27
- Lexmark Mobile Print
 - using 24
- Lexmark ScanBack Utility 50
- light print 165

LINE port 14
linking trays 20
loading
 multipurpose feeder 19
loading envelopes
 in the multipurpose feeder 19
loading trays 17
locating paper jams 145
locating the security slot 118

M

making copies 26
Media Types menu 73
memory
 types installed on printer 119
memory card
 installing 204
menu
 802.1x 106
 About this Printer 63
 Anonymous Data Collection 59
 Confidential Print Setup 113
 Configuration Menu 59
 Copy Defaults 73
 Custom Scan Sizes 72
 Device 115
 Eco-Mode 55
 Ethernet 101
 E-mail Defaults 87
 E-mail Setup 86
 Fax 116
 Fax Cover Page 84
 Fax Log Settings 84
 Fax Mode 76
 Fax Receive Settings 81
 Fax Send Settings 78
 FTP Defaults 93
 General Fax Settings 76
 Google Cloud Print 108
 HTML 70
 HTTP/FTP Settings 107
 Image 70
 IPSec 105
 Job Accounting 66
 Layout 63
 Login Restrictions 113
 LPD Configuration 106
 Media Types 73
 Menu Settings Page 115
 Miscellaneous 114
 Mobile Services
 Management 114

Network 116
Network Overview 98
Notifications 56
Out of Service Erase 62
PCL 68
PDF 67
PostScript 67
Power Management 58
Preferences 54
Print 115
Quality 65
Remote Operator Panel 56
Restore Factory Defaults 59
Security Audit Log 110
Setup 64
Shortcuts 116
SNMP 104
Solutions LDAP Settings 114
Speaker Settings 85
TCP/IP 103
ThinPrint 108
Tray Configuration 71
Troubleshooting 117
Universal Setup 72
USB 108
Visible Home Screen Icons 63
Web Link Setup 93
Wi-Fi Direct 109
XPS 67
Menu Settings Page
 printing 117
menus
 Wireless 99
missing information on the fax
 cover page 198
mobile device
 connecting to printer 122
 printing from 24, 25
Mopria Print Service 24
mottled print 167
moving the printer 12, 141
multipurpose feeder
 loading 19

N

network folder
 creating a shortcut 52
noise emission levels 215
non-genuine toner 188
Non-Lexmark supply 188
non-volatile memory 119
 erasing 118

notices 215, 216, 217, 218, 219,
223, 226

O

optional card
 installing 206
ordering
 imaging unit 128
ordering supplies
 toner cartridge 127
Out of Service Erase menu 62

P

paper curl 168
paper jam in door A 146
paper jam in the automatic
 document feeder 154
paper jam in the duplex unit 152
paper jam in the multipurpose
 feeder 153
paper jam in the rear door 150
paper jam in trays 153
paper jam, clearing
 in the automatic document
 feeder 154
 in the duplex unit 152
 in the multipurpose feeder 153
 in the rear door 150
 trays 153
paper jams
 avoiding 144
paper jams, clearing
 in the standard bin 151
personal identification number
 method 121
photos
 copying 26
pick roller assembly
 replacing 135
pick tires
 replacing 133
placing separator sheets
 between copies
 copying 28
power button light
 understanding the status 16
power saver modes
 setting 142
print driver
 hardware options, adding 211
 installing 209

- print jobs not printed 180
- print quality problem
 - gray background on prints 162
- print quality problems 156
- print quality troubleshooting
 - blank or white pages 157
 - crooked print 169
 - dark print 158
 - fine lines are not printed
 - correctly 160
 - folded or wrinkled paper 161
 - horizontal light bands 164
 - light print 165
 - mottled print and dots 167
 - paper curl 168
 - print quality problems 156
 - repeating defects 179
 - skewed print 169
 - solid black pages 170
 - text or images cut off 172
 - toner easily rubs off 173
 - vertical dark bands 174
 - vertical dark lines or streaks 176
 - vertical dark streaks with print missing 177
 - vertical light bands 178
 - vertical white lines 178
- print troubleshooting
 - collated printing does not work 190
 - confidential and other held documents do not print 181
 - envelope seals when printing 189
 - incorrect margins 164
 - jammed pages are not reprinted 192
 - job prints from the wrong tray 182
 - job prints on the wrong paper 182
 - paper frequently jams 191
 - print jobs do not print 180
 - slow printing 182
 - tray linking does not work 190
- printer
 - minimum clearances 12
 - selecting a location 12
 - shipping 142
- printer configurations 13

- printer information
 - finding 10
- printer is not responding 184
- printer menus 53
- printer messages
 - Non-Lexmark supply 188
 - refilled regular cartridge 188
 - Replace cartridge, printer region mismatch 188
- printer options troubleshooting
 - cannot detect internal option 187
- printer parts
 - checking the status 126
- printer ports 14
- printer serial number
 - finding 11
- printer settings
 - restoring to factory defaults 119
- printer software
 - installing 209
- printer status 16
- printing
 - fax log 47
 - font sample list 25
 - from a computer 24
 - from a mobile device 24, 25
 - Menu Settings Page 117
 - quality test pages 117
 - using Mopria Print Service 24
 - using Wi-Fi Direct 25
- printing a font sample list 25
- printing a network setup page 186
- printing from a computer 24
- Push Button method 121

R

- recycling
 - Lexmark packaging 143
 - Lexmark products 143
- reducing a copy 27
- removing paper jam
 - in door A 146
- Replace cartridge, printer region mismatch 188
- replacing parts
 - ADF separator roller 139
- replacing supplies
 - imaging unit 131
 - toner cartridge 129

- replacing the pick roller assembly 135
- replacing the pick tires 133
- resetting
 - supply usage counters 188
- resetting the supply usage counters 188
- restoring factory default settings 119
- restoring printer settings to factory defaults 119
- RJ11 adapter 42

S

- safety information 7, 8, 9
- saving paper 28
- scan troubleshooting
 - cannot scan from a computer 199
 - partial copies of documents or photos 199
 - poor copy quality 200
 - scan job was not successful 201
 - scanner does not respond 202
 - scanning freezes the computer 202
 - scanning takes too long 202
 - vertical dark streaks on output when scanning from the ADF 200
- scanner
 - cleaning 124
- scanner does not close 201
- scanner glass
 - using 26, 29, 45, 50
- scanning
 - to a computer 50
 - to an FTP server 52
 - using the automatic document feeder (ADF) 50
 - using the scanner glass 50
- scanning quality problem 200
- scheduling fax 46
- security slot
 - locating 118
- selecting a location for the printer 12
- sending an e-mail 37
- sending fax 45
- serial number, printer
 - finding 11

- setting the card stock size 17
- setting the envelope size 17
- setting the label size 17
- setting up
 - analog fax 39
- setting up fax
 - country- or region-specific 42
 - standard telephone line connection 40
- setting up fax function
 - using etherFAX 40
- shipping the printer 142
- skewed print 169
- Sleep mode
 - setting 142
- SMTP settings
 - configuring 29
- sorting multiple copies 27
- specialty media
 - setting the paper size 17
 - setting the paper type 17
- statement of volatility 119
- supplies
 - checking the status 126
 - conserving 143
- supply notifications
 - configuring 128
- supply usage counters
 - resetting 188
- supported fax 38
- supported paper sizes 21
- supported paper types 23
- supported paper weights 23

T

- third-party supplies 188
- toner cartridge
 - ordering 127
 - replacing 129
- toner darkness
 - adjusting 185
- trays
 - installing 208
 - linking 20
 - loading 17
 - unlinking 20
- troubleshooting
 - cannot open Embedded Web Server 185
 - print quality problems 156
 - printer is not responding 184

- troubleshooting, copy
 - partial copies of documents or photos 199
 - poor copy quality 200
 - scanner does not close 201
 - scanner does not respond 202
- troubleshooting, e-mail
 - cannot send e-mails 192
- troubleshooting, fax
 - caller ID is not shown 193
 - cannot send faxes using analog fax 196
 - cannot send or receive faxes using analog fax 194
 - cannot send or receive faxes using etherFAX 196
 - cannot send the fax cover page from the computer 198
 - cannot set up etherFAX 193
 - missing information on the fax cover page 198
 - received fax has poor print quality 197
- troubleshooting, print
 - collated printing does not work 190
 - confidential and other held documents do not print 181
 - envelope seals when printing 189
 - incorrect margins 164
 - jammed pages are not reprinted 192
 - job prints from the wrong tray 182
 - job prints on the wrong paper 182
 - paper frequently jams 191
 - print jobs do not print 180
 - slow printing 182
 - tray linking does not work 190
- troubleshooting, print quality
 - blank or white pages 157
 - crooked print 169
 - dark print 158
 - fine lines are not printed correctly 160
 - folded or wrinkled paper 161
 - horizontal light bands 164
 - light print 165
 - mottled print and dots 167
 - paper curl 168

- repeating defects 179
- skewed print 169
- solid black pages 170
- text or images cut off 172
- toner easily rubs off 173
- vertical dark bands 174
- vertical dark lines or streaks 176
- vertical dark streaks with print missing 177
- vertical light bands 178
- vertical white lines 178
- troubleshooting, printer options
 - cannot detect internal option 187
- troubleshooting, scan
 - cannot scan from a computer 199
 - partial copies of documents or photos 199
 - poor copy quality 200
 - scan job was not successful 201
 - scanner does not close 201
 - scanner does not respond 202
 - vertical dark streaks on output when scanning from the ADF 200
- two-sided copying 27

U

- Universal paper settings
 - configuring 17
- unlinking trays 20
- updating firmware
 - using Embedded Web Server 213
 - using the control panel 212
- USB port 14
 - enabling 186
- using genuine Lexmark parts and supplies 127
- using the ADF
 - copying 26
- using the automatic document feeder (ADF) 26, 29, 45, 50
- using the control panel 15
- using the scanner
 - glass 26, 29, 45, 50
 - copying 26

V

- vertical dark lines on prints 176
- vertical dark streaks on output
when scanning from the
ADF 200
- vertical streaks on prints 176
- volatile memory 119
 - erasing 118
- volatility
 - statement of 119

W

- white lines 178
- white pages 157
- Wi-Fi Direct
 - configuring 122
- Wireless menu 99
- wireless network
 - connecting the printer to 120
 - deactivating 123
 - Wi-Fi Protected Setup 121
- wireless networking 120
- Wi-Fi Direct
 - enabling 122
 - printing from a mobile
device 25
- Wi-Fi network
 - deactivating 123
- Wi-Fi Protected Setup
 - wireless network 121
- wrinkled paper 161