



# **MX822, MX826, XM7355, XM7370 MFPs**

---

## **User's Guide**

**March 2024**

**[www.lexmark.com](http://www.lexmark.com)**

---

Machine type:

7465

Models:

436, 496, 836, 896

# Contents

- Safety information.....7**
  - Conventions.....7
  - Product statements.....7
  
- Learning about the printer..... 11**
  - Finding information about the printer..... 11
  - Finding the printer serial number.....12
  - Selecting a location for the printer..... 13
  - Printer configurations..... 14
  - Attaching cables..... 17
  - Using the control panel..... 18
  - Understanding the status of the power button and indicator light..... 18
  
- Setting up and using the home screen applications..... 20**
  - Using the home screen..... 20
  - Customizing the home screen..... 21
  - Supported applications.....21
  - Setting up Card Copy.....21
  - Creating a shortcut..... 22
  - Using Display Customization..... 22
  - Setting up Scan Center.....23
  - Setting up Device Quotas..... 23
  - Using QR Code Generator.....24
  - Configuring Eco-Settings..... 24
  - Using Customer Support..... 24
  - Creating a Cloud Connector profile..... 24
  - Managing bookmarks..... 25
  - Managing contacts.....26
  
- Setting up and using the accessibility features..... 28**
  - Enabling Magnification mode..... 28
  - Activating Voice Guidance.....28
  - Adjusting the Voice Guidance speech rate.....28
  - Navigating the screen using gestures.....28
  - Using the keyboard on the display.....29

---

Enabling spoken passwords or personal identification numbers.....	29
<b>Loading paper and specialty media.....</b>	<b>30</b>
Setting the size and type of the specialty media.....	30
Configuring Universal paper settings.....	30
Loading the 550-sheet tray.....	30
Loading the 2100-sheet tray.....	33
Loading the multipurpose feeder.....	38
Linking trays.....	39
<b>Paper support.....</b>	<b>40</b>
Supported paper sizes.....	40
Supported paper types.....	43
Supported paper weights.....	44
<b>Printing.....</b>	<b>47</b>
Printing from a computer.....	47
Printing from a mobile device.....	47
Printing from a flash drive.....	49
Supported flash drives and file types.....	50
Configuring confidential jobs.....	50
Printing confidential and other held jobs.....	51
Printing from a Cloud Connector profile.....	52
Printing a font sample list.....	52
Printing a directory list.....	52
Canceling a print job.....	52
<b>Copying.....</b>	<b>54</b>
Using the automatic document feeder and scanner glass.....	54
Making copies.....	54
Copying photos.....	54
Copying on letterhead.....	55
Copying on both sides of the paper.....	55
Reducing or enlarging copies.....	55
Collating copies.....	55
Placing separator sheets between copies.....	55
Copying multiple pages onto a single sheet.....	56

Creating a copy shortcut..... 56

**E-mailing..... 57**

Using the automatic document feeder and scanner glass.....57

Configuring the e-mail SMTP settings..... 57

Sending an e-mail..... 65

Creating an e-mail shortcut..... 65

**Faxing.....66**

Using the automatic document feeder and scanner glass..... 66

Setting up the printer to fax.....66

Sending a fax..... 74

Scheduling a fax..... 75

Creating a fax destination shortcut.....75

Changing the fax resolution..... 76

Adjusting the fax darkness.....76

Printing a fax log..... 76

Blocking junk faxes..... 76

Holding faxes.....76

Forwarding a fax..... 77

**Scanning..... 78**

Using the automatic document feeder and scanner glass.....78

Scanning to a computer.....78

Scanning to an FTP server..... 79

Scanning to a network folder.....80

Creating an FTP shortcut..... 80

Scanning to a flash drive.....80

Scanning to a Cloud Connector profile..... 81

**Understanding the printer menus.....82**

Menu map..... 82

Device.....83

Print..... 97

Paper.....106

Copy.....109

Fax.....113



---

E-mail.....	126
FTP.....	132
USB Drive.....	137
Network/Ports.....	143
Security.....	155
Reports.....	162
Help.....	163
Troubleshooting.....	164
Printing the Menu Settings Page.....	164
<b>Securing the printer.....</b>	<b>165</b>
Locating the security slot.....	165
Erasing printer memory.....	165
Erasing printer hard disk memory.....	165
Encrypting the printer hard disk.....	166
Restoring factory default settings.....	166
Statement of Volatility.....	166
<b>Maintaining the printer.....</b>	<b>168</b>
Configuring supply notifications.....	168
Setting up e-mail alerts.....	168
Viewing reports.....	168
Adjusting the speaker volume.....	169
Networking.....	169
Setting up serial printing (Windows only).....	173
Cleaning printer parts.....	173
Ordering parts and supplies.....	188
Replacing parts and supplies.....	192
Moving the printer.....	217
Saving energy and paper.....	218
Recycling.....	219
<b>Clearing jams.....</b>	<b>221</b>
Avoiding jams.....	221
Identifying jam locations.....	222
Paper jam in trays.....	223
Paper jam in door A.....	224

Paper jam in door C..... 226

Paper jam in the standard bin.....227

Paper jam in the multipurpose feeder.....228

Paper jam in the automatic document feeder.....229

Paper jam in the 4-bin mailbox..... 231

Paper jam in the offset stacker or staple finisher..... 232

Paper jam in the staple, hole punch finisher.....234

Staple jam in the staple finisher..... 235

Staple jam in the staple, hole punch finisher.....238

**Troubleshooting..... 241**

Print quality problems..... 241

Printing problems.....242

The printer is not responding..... 272

Unable to read flash drive.....273

Enabling the USB port..... 273

Network connection problems..... 273

Hardware options problems..... 276

Issues with supplies.....277

Paper feed problems..... 279

E-mailing problems.....283

Faxing problems.....284

Scanning problems..... 289

Contacting customer support.....296

**Upgrading and migrating..... 297**

Hardware.....297

Software..... 318

Firmware.....321

**Notices..... 324**

**Index..... 341**

# Safety information

## Conventions





**Note:** A *note* identifies information that could help you.

**Warning:** A *warning* identifies something that could damage the product hardware or software.







**WARNING (in full capitals):** A *WARNING* indicates a risk of death or serious injury if not avoided.









**CAUTION:** A *caution* indicates a potentially hazardous situation that could injure you.







Different types of caution statements include:

-  **CAUTION—POTENTIAL INJURY:** Indicates a risk of injury.
-  **CAUTION—SHOCK HAZARD:** Indicates a risk of electrical shock.
-  **CAUTION—HOT SURFACE:** Indicates a risk of burn if touched.
-  **CAUTION—TIPPING HAZARD:** Indicates a crush hazard.
-  **CAUTION—PINCH HAZARD:** Indicates a risk of being caught between moving parts.

## Product statements

-  **CAUTION—POTENTIAL INJURY:** To avoid the risk of fire or electrical shock, connect the power cord to an appropriately rated and properly grounded electrical outlet that is near the product and easily accessible.
-  **CAUTION—POTENTIAL INJURY:** To avoid the risk of fire or electrical shock, use only the power cord provided with this product or the manufacturer's authorized replacement.
-  **CAUTION—POTENTIAL INJURY:** Do not use this product with extension cords, multioutlet power strips, multioutlet extenders, or UPS devices. The power capacity of these types of accessories can be easily overloaded by a laser printer and may result in a risk of fire, property damage, or poor printer performance.
-  **CAUTION—POTENTIAL INJURY:** Only a Lexmark Inline Surge Protector that is properly connected between the printer and the power cord provided with the printer may be used with this product. The use of non-Lexmark surge protection devices may result in a risk of fire, property damage, or poor printer performance.
-  **CAUTION—POTENTIAL INJURY:** To reduce the risk of fire, use only a 26 AWG or larger telecommunications (RJ-11) cord when connecting this product to the public switched telephone network. For users in Australia, the cord must be approved by the Australian Communications and Media Authority.
-  **CAUTION—SHOCK HAZARD:** To avoid the risk of electrical shock, do not place or use this product near water or wet locations.

-  **CAUTION—SHOCK HAZARD:** To avoid the risk of electrical shock, do not set up this product or make any electrical or cabling connections, such as the power cord, fax feature, or telephone, during a lightning storm.
-  **CAUTION—POTENTIAL INJURY:** Do not cut, twist, bind, crush, or place heavy objects on the power cord. Do not subject the power cord to abrasion or stress. Do not pinch the power cord between objects such as furniture and walls. If any of these things happen, a risk of fire or electrical shock results. Inspect the power cord regularly for signs of such problems. Remove the power cord from the electrical outlet before inspecting it.
-  **CAUTION—SHOCK HAZARD:** To avoid the risk of electrical shock, make sure that all external connections (such as Ethernet and telephone system connections) are properly installed in their marked plug-in ports.
-  **CAUTION—SHOCK HAZARD:** To avoid the risk of electrical shock, if you are accessing the controller board or installing optional hardware or memory devices sometime after setting up the printer, then turn the printer off, and unplug the power cord from the electrical outlet before continuing. If you have any other devices attached to the printer, then turn them off as well, and unplug any cables going into the printer.
-  **CAUTION—SHOCK HAZARD:** To avoid the risk of electrical shock, do not use the fax feature during a lightning storm.
-  **CAUTION—SHOCK HAZARD:** To avoid the risk of electrical shock when cleaning the exterior of the printer, unplug the power cord from the electrical outlet and disconnect all cables from the printer before proceeding.
-  **CAUTION—POTENTIAL INJURY:** If the printer weight is greater than 20 kg (44 lb), then it may require two or more people to lift it safely.
-  **CAUTION—POTENTIAL INJURY:** When moving the printer, follow these guidelines to avoid personal injury or printer damage:
- Make sure that all doors and trays are closed.
  - Turn off the printer, and then unplug the power cord from the electrical outlet.
  - Disconnect all cords and cables from the printer.
  - If the printer has separate floor-standing optional trays or output options attached to it, then disconnect them before moving the printer.
  - If the printer has a caster base, then carefully roll it to the new location. Use caution when passing over thresholds and breaks in flooring.
  - If the printer does not have a caster base but is configured with optional trays or output options, then remove the output options and lift the printer off the trays. Do not try to lift the printer and any options at the same time.
  - Always use the handholds on the printer to lift it.
  - Any cart used to move the printer must have a surface able to support the full footprint of the printer.
  - Any cart used to move the hardware options must have a surface able to support the dimensions of the options.
  - Keep the printer in an upright position.
  - Avoid severe jarring movements.
  - Make sure that your fingers are not under the printer when you set it down.
  - Make sure that there is adequate clearance around the printer.

-  **CAUTION—TIPPING HAZARD:** Installing one or more options on your printer or MFP may require a caster base, furniture, or other feature to prevent instability causing possible injury. For more information on supported configurations, see [www.lexmark.com/multifunctionprinters](http://www.lexmark.com/multifunctionprinters).
-  **CAUTION—TIPPING HAZARD:** To reduce the risk of equipment instability, load each tray separately. Keep all other trays closed until needed.
-  **CAUTION—HOT SURFACE:** The inside of the printer might be hot. To reduce the risk of injury from a hot component, allow the surface to cool before touching it.
-  **CAUTION—PINCH HAZARD:** To avoid the risk of a pinch injury, use caution in areas marked with this label. Pinch injuries may occur around moving parts, such as gears, doors, trays, and covers.
-  **CAUTION—POTENTIAL INJURY:** This product uses a laser. Use of controls or adjustments or performance of procedures other than those specified in the *User's Guide* may result in hazardous radiation exposure.
-  **CAUTION—POTENTIAL INJURY:** The lithium battery in this product is not intended to be replaced. There is a danger of explosion if a lithium battery is incorrectly replaced. Do not recharge, disassemble, or incinerate a lithium battery. Discard used lithium batteries according to the manufacturer's instructions and local regulations.



## WARNING

- **INGESTION HAZARD:** This product contains a button cell or coin battery.
- **DEATH** or serious injury can occur if ingested.
- A swallowed button cell or coin battery can cause **Internal Chemical Burns** in as little as **2 hours**.
- **KEEP** new and used batteries **OUT OF REACH of CHILDREN**.
- **Seek immediate medical attention** if a battery is suspected to be swallowed or inserted inside any part of the body.



Remove and immediately recycle or dispose of used batteries according to local regulations and keep away from children. Do not dispose of batteries in household trash or incinerate. Even used batteries may cause severe injury or death. Call a local poison control center for treatment information.

Battery type: CR6821

Nominal battery voltage: 3V

Do not force discharge, recharge, disassemble, heat above 60°C (140°F), or incinerate. Doing so may result in injury due to venting, leakage, or explosion resulting in chemical burns.

This product is designed, tested, and approved to meet strict global safety standards with the use of specific manufacturer's components. The safety features of some parts may not always be obvious. The manufacturer is not responsible for the use of other replacement parts.

Refer service or repairs, other than those described in the user documentation, to a service representative.

This product uses a printing process that heats the print media, and the heat may cause the media to release emissions. You must understand the section in your operating instructions that discusses the guidelines for selecting print media to avoid the possibility of harmful emissions.

This product may produce small amounts of ozone during normal operation, and may be equipped with a filter designed to limit ozone concentrations to levels well below the recommended exposure limits. To avoid high

---

ozone concentration levels during extensive usage, install this product in a well-ventilated area and replace the ozone and exhaust filters if instructed to do so in the product maintenance instructions. If there are no references to filters in the product maintenance instructions, then there are no filters requiring replacement for this product.

**SAVE THESE INSTRUCTIONS.**

# Learning about the printer

## Finding information about the printer

What are you looking for?	Find it here
Initial setup instructions	See the setup documentation that came with the printer.
<ul style="list-style-type: none"> <li>• Printer software</li> <li>• Print or fax driver</li> <li>• Printer firmware</li> <li>• Utility</li> </ul>	Go to <a href="http://www.lexmark.com/downloads">www.lexmark.com/downloads</a> , search for your printer model, and then in the Type menu, select the driver, firmware, or utility that you need.
<ul style="list-style-type: none"> <li>• Selecting and storing paper and specialty media</li> <li>• Loading paper</li> <li>• Configuring printer settings</li> <li>• Viewing and printing documents and photos</li> <li>• Configuring the printer on a network</li> <li>• Caring for and maintaining the printer</li> <li>• Troubleshooting and solving problems</li> </ul>	<p>Information Center—Go to <a href="https://infoserve.lexmark.com">https://infoserve.lexmark.com</a>.</p> <p>How-to videos—Go to <a href="https://infoserve.lexmark.com/idv/">https://infoserve.lexmark.com/idv/</a>.</p> <p><i>Help Menu Pages</i>—Access the guides on the printer firmware, or go to <a href="http://support.lexmark.com">http://support.lexmark.com</a>.</p> <p><i>Touch Screen Guide</i>—Go to <a href="http://support.lexmark.com">http://support.lexmark.com</a>.</p>
Setting up and configuring the accessibility features of your printer	<i>Lexmark Accessibility Guide</i> —Go to <a href="http://support.lexmark.com">http://support.lexmark.com</a> .
Help information for using the printer software	<p>Help for Microsoft Windows or Macintosh operating systems—Open a printer software program or application, and then click <b>Help</b>.</p> <p>Click  to view context-sensitive information.</p> <p><b>Notes:</b></p> <ul style="list-style-type: none"> <li>• Help is automatically installed with the printer software.</li> <li>• Depending on the operating system, the printer software is either in the printer program folder or on the desktop.</li> </ul>

What are you looking for?	Find it here
<ul style="list-style-type: none"> <li>• Documentation</li> <li>• Live chat support</li> <li>• E-mail support</li> <li>• Voice support</li> </ul>	<p>Go to <a href="http://support.lexmark.com">http://support.lexmark.com</a>.</p> <p><b>Note:</b> Select your country or region, and then select your product to view the appropriate support site.</p> <p>Support contact information for your country or region can be found on the website or on the printed warranty that came with the printer.</p> <p>Have the following information ready when you contact customer support:</p> <ul style="list-style-type: none"> <li>• Place and date of purchase</li> <li>• Machine type and serial number</li> </ul> <p>For more information, see <a href="#">“Finding the printer serial number” on page 12</a>.</p>
<ul style="list-style-type: none"> <li>• Safety information</li> <li>• Regulatory information</li> <li>• Warranty information</li> <li>• Environmental information</li> </ul>	<p>Warranty information varies by country or region:</p> <ul style="list-style-type: none"> <li>• <b>In the U.S.</b>—See the Statement of Limited Warranty included with the printer, or go to <a href="http://support.lexmark.com">http://support.lexmark.com</a>.</li> <li>• <b>In other countries and regions</b>—See the printed warranty that came with the printer.</li> </ul> <p><i>Product Information Guide</i>—See the documentation that came with the printer or go to <a href="http://support.lexmark.com">http://support.lexmark.com</a>.</p>

## Finding the printer serial number

- 1 Open door A.

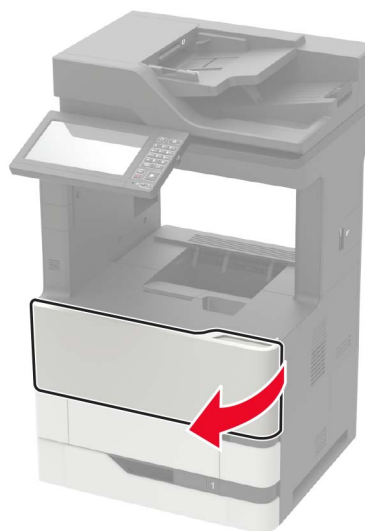



- 2 Locate the serial number at the left side of the printer.



## Selecting a location for the printer

- Leave enough room to open trays, covers, and doors and to install hardware options.
- Set up the printer near an electrical outlet.

**⚠ CAUTION—POTENTIAL INJURY:** To avoid the risk of fire or electrical shock, connect the power cord to an appropriately rated and properly grounded electrical outlet that is near the product and easily accessible.

**⚠ CAUTION—SHOCK HAZARD:** To avoid the risk of electrical shock, do not place or use this product near water or wet locations.

- Make sure that airflow in the room meets the latest revision of the ASHRAE 62 standard or the CEN Technical Committee 156 standard.
- Provide a flat, sturdy, and stable surface.
- Keep the printer:
  - Clean, dry, and free of dust
  - Away from stray staples and paper clips
  - Away from the direct airflow of air conditioners, heaters, or ventilators
  - Free from direct sunlight and humidity extremes
- Observe the recommended temperatures and avoid fluctuations.

Ambient temperature	10 to 32.2°C (50 to 90°F)
Storage temperature	-40 to 43.3°C (-40 to 110°F)

- Allow the following recommended amount of space around the printer for proper ventilation:

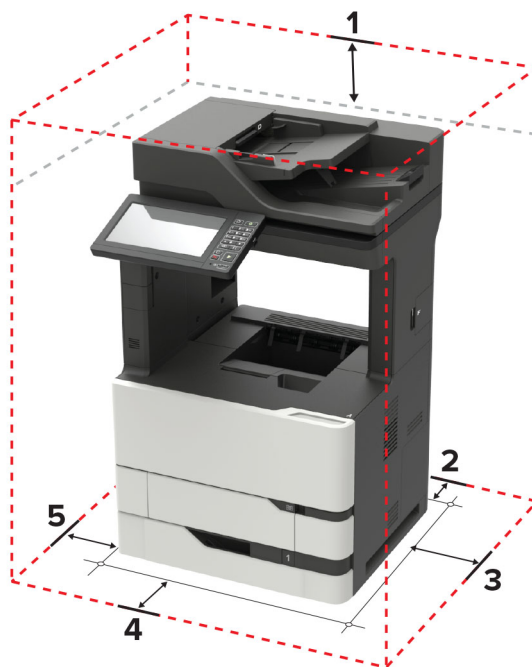

1	Top	152 mm (6 in.)
2	Rear	152 mm (6 in.)
3	Right side	152 mm (6 in.)
4	Front	406 mm (16 in.) <b>Note:</b> The minimum space needed in front of the printer is 75 mm (3 in.)
5	Left side	152 mm (6 in.)

## Printer configurations

**CAUTION—TIPPING HAZARD:** Installing one or more options on your printer or MFP may require a caster base, furniture, or other feature to prevent instability causing possible injury. For more information on supported configurations, see [www.lexmark.com/multifunctionprinters](http://www.lexmark.com/multifunctionprinters).

**CAUTION—TIPPING HAZARD:** To reduce the risk of equipment instability, load each tray separately. Keep all other trays closed until needed.

You can configure your printer by adding optional 550- or 2100-sheet trays. For more information, see [“Installing the 550-sheet tray” on page 309](#) or [“Installing the 2100-sheet tray” on page 310](#).

## Basic model



<b>1</b>	Automatic document feeder (ADF) tray
<b>2</b>	ADF bin
<b>3</b>	Standard bin
<b>4</b>	Multipurpose feeder
<b>5</b>	Standard 550-sheet tray
<b>6</b>	Control panel
<b>7</b>	ADF

### Configured model



	Hardware option	Alternative hardware option
1	4-bin mailbox	<ul style="list-style-type: none"> <li>• Offset stacker</li> <li>• Staple finisher</li> <li>• Staple, hole punch finisher</li> </ul>
2	2100-sheet tray	550-sheet trays
3	Caster base	Caster base
4	550-sheet trays	2100-sheet tray
5	Staple finisher	<ul style="list-style-type: none"> <li>• 4-bin mailbox</li> <li>• Staple, hole punch finisher</li> <li>• Offset stacker</li> </ul>

When using optional trays:

- Always use a caster base when the printer is configured with a 2100-sheet tray.
- The 2100-sheet tray must always be at the bottom of a configuration.
- If the 2100-sheet tray is installed, then you cannot use an optional 550-sheet tray.
- A maximum of two optional trays may be configured with the printer.
- The printer supports only one finisher at a time.

## Attaching cables

- ⚠ CAUTION—SHOCK HAZARD:** To avoid the risk of electrical shock, do not set up this product or make any electrical or cabling connections, such as the power cord, fax feature, or telephone, during a lightning storm.
- ⚠ CAUTION—POTENTIAL INJURY:** To avoid the risk of fire or electrical shock, connect the power cord to an appropriately rated and properly grounded electrical outlet that is near the product and easily accessible.
- ⚠ CAUTION—POTENTIAL INJURY:** To avoid the risk of fire or electrical shock, use only the power cord provided with this product or the manufacturer's authorized replacement.
- ⚠ CAUTION—POTENTIAL INJURY:** To reduce the risk of fire, use only a 26 AWG or larger telecommunications (RJ-11) cord when connecting this product to the public switched telephone network. For users in Australia, the cord must be approved by the Australian Communications and Media Authority.

**Warning—Potential Damage:** To avoid loss of data or printer malfunction, do not touch the USB cable, any wireless network adapter, or the printer in the areas shown while actively printing.



	Printer port	Function
1	Power cord socket	Connect the printer to a properly grounded electrical outlet.
2	USB printer port	Connect the printer to a computer.
3	Ethernet port	Connect the printer to a network.
4	USB port	Attach a keyboard or any compatible option.
5	EXT port <b>Note:</b> Available only in some printer models.	Connect more devices (telephone or answering machine) to the printer and the telephone line. Use this port if you do not have a dedicated fax line for the printer and if this connection method is supported in your country or region.
6	LINE port <b>Note:</b> Available only in some printer models.	Connect the printer to an active telephone line through a standard wall jack (RJ-11), DSL filter, or VoIP adapter, or any other adapter that allows you to access the telephone line to send and receive faxes.

## Using the control panel

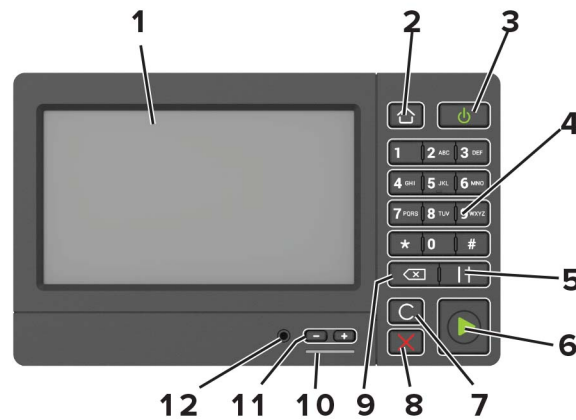

	Use the	To
1	Display	<ul style="list-style-type: none"> <li>View the printer messages and supply status.</li> <li>Set up and operate the printer.</li> </ul>
2	Home button	Go to the home screen.
3	Power button	<ul style="list-style-type: none"> <li>Turn on or turn off the printer.</li> </ul> <p><b>Note:</b> To turn off the printer, press and hold the power button for five seconds.</p> <ul style="list-style-type: none"> <li>Set the printer to Sleep or Hibernate mode.</li> <li>Wake the printer from Sleep or Hibernate mode.</li> </ul>
4	Keypad	Enter numbers or symbols in an input field.
5	Pause button	Place a dial pause in a fax number.
6	Start button	Start a job, depending on which mode is selected.
7	Clear all or Reset button	Reset the default settings of a function such as copying, faxing, or scanning.
8	Stop or Cancel button	Stop the current job.
9	Backspace button	Move the cursor backward and delete a character in an input field.
10	Indicator light	Check the status of the printer.
11	Volume buttons	Adjust the volume of the headset or speaker.
12	Headset or speaker port	Attach a headset or speaker. <b>Note:</b> This feature is available only in some printer units.

## Understanding the status of the power button and indicator light

Indicator light	Printer status
Off	The printer is off or in Hibernate mode.
Blue	The printer is ready or processing data.

Indicator light	Printer status
Red	The printer requires user intervention.

Power button light	Printer status
Off	The printer is off, ready, or processing data.
Solid amber	The printer is in Sleep mode.
Blinking amber	The printer is in Hibernate mode.

# Setting up and using the home screen applications

## Using the home screen

**Note:** Your home screen may vary depending on your home screen customization settings, administrative setup, and active embedded solutions.



Touch		To
1	Copy	Make copies.
2	E-mail	Send e-mails.
3	Settings	Access the printer menus.
4	Fax	Send fax.
5	Address Book	Manage a contact list that other applications on the printer can access.
6	Status/Supplies	<ul style="list-style-type: none"> <li>Show a printer warning or error message whenever the printer requires intervention to continue processing.</li> <li>View more information on the printer warning or message, and on how to clear it.</li> </ul> <p><b>Note:</b> You can also access this setting by touching the top section of the home screen.</p>
7	USB Drive	<ul style="list-style-type: none"> <li>Print photos and documents from a flash drive.</li> <li>Scan photos and documents to a flash drive</li> </ul>
8	Job Queue	Show all the current print jobs. <b>Note:</b> You can also access this setting by touching the top section of the home screen.
9	Held Jobs	Show the print jobs that are held in the printer memory.
10	Shortcut Center	Organize all shortcuts.
11	App Profiles	Access application profiles.



Touch		To
12	Scan Profiles	Scan and save documents directly to the computer.
13	FTP	Scan and save documents directly to an FTP server.
14	Bookmarks	Organize all bookmarks.
15	Change Language	Change the language on the display.

Customizing the home screen

## Customizing the home screen

- 1 From the control panel, touch **Settings > Device > Visible Home Screen Icons**.
- 2 Select the icons that you want to appear on the home screen.
- 3 Apply the changes.

## Supported applications

Application	Printer models
Scan Center	MX822, MX826, XM7355, XM7370
Shortcut Center	MX822, MX826, XM7355, XM7370
Card Copy	MX822, MX826, XM7355, XM7370
Display Customization	MX822, MX826, XM7355, XM7370
Cloud Connector	MX822, MX826, XM7355, XM7370
Customer Support	XM7355, XM7370
Device Quotas	XM7355, XM7370
QR Code	XM7355, XM7370
Eco-Settings	XM7355, XM7370

## Setting up Card Copy

- 1 Open a web browser, and then type the printer IP address in the address field.

**Notes:**

- View the printer IP address on the printer home screen. The IP address appears as four sets of numbers separated by periods, such as 123.123.123.123.
- If you are using a proxy server, then temporarily disable it to load the web page correctly.

- 2 Click **Apps > Card Copy > Configure**.

**Notes:**

- Make sure that Display Icon is enabled.

- Make sure that E-mail Settings and Network Share Settings are configured.
- When scanning a card, make sure that the scan resolution does not exceed 200 dpi for color and 400 dpi for black and white.
- When scanning multiple cards, make sure that the scan resolution does not exceed 150 dpi for color and 300 dpi for black and white.

**3** Apply the changes.

**Note:** You need a printer hard disk to scan multiple cards.

## Creating a shortcut

**1** From the home screen, touch **Shortcut Center**.

**Note:** The icon and name may have been changed. For more information, contact your administrator.

**2** Select a printer function, and then touch **Create Shortcut**.

**Note:** The Secure E-mail function is not supported.

**3** Configure the settings, and then touch **Save**.

**4** Type a unique shortcut name.

**Note:** To avoid clipped names on the home screen, type only up to 25 characters.

**5** Touch **OK**.

The application automatically generates a unique shortcut number. To launch the shortcut, press **#** and then the shortcut number.

## Using Display Customization

Before using the application, make sure to do the following:

- From the Embedded Web Server, click **Apps > Display Customization > Configure**.
- Enable and configure the screen saver, slideshow, and wallpaper settings.

### Managing screen saver and slide show images

**1** From the Screen Saver and Slideshow Images section, add, edit, or delete an image.

**Notes:**

- You can add up to 10 images.
- When enabled, the status icons appear on the screen saver only when there are errors, warnings, or cloud-based notifications.

**2** Apply the changes.

### Changing the wallpaper image

**1** From the home screen, touch **Change Wallpaper**.

**2** Select an image to use.

**3** Apply the changes.

## Running a slide show from a flash drive

- 1 Insert a flash drive into the USB port.
- 2 From the home screen, touch **Slideshow**.  
Images appear in alphabetical order.

**Note:** You can remove the flash drive after the slide show starts, but the images are not stored in the printer. If the slide show stops, then insert the flash drive again to view the images.

## Setting up Scan Center

- 1 From the home screen, touch **Scan Center**.
- 2 Select and create a destination, and then configure the settings.

**Notes:**

- When creating a network destination, make sure to validate and adjust the settings until no errors occur.
- Only destinations created from the Embedded Web Server are saved. For more information, see the documentation that came with the solution.

- 3 Apply the changes.

## Setting up Device Quotas

**Notes:**

- This application is supported only in some printer models. For more information, see [“Supported applications” on page 21](#).
- You may need administrative rights to access the application.

- 1 Open a web browser, and then type the printer IP address in the address field.

**Notes:**

- View the printer IP address on the printer home screen. The IP address appears as four sets of numbers separated by periods, such as 123.123.123.123.
- If you are using a proxy server, then temporarily disable it to load the web page correctly.

- 2 Click **Apps > Device Quotas > Configure**.
- 3 In the User Accounts section, add or edit a user, and then set the user quota.
- 4 Apply the changes.

**Note:** For information on how to configure the application and its security settings, see the *Device Quotas Administrator's Guide*.

## Using QR Code Generator

### Notes:

- This application is supported only in some printer models. For more information, see [“Supported applications” on page 21](#).
- You may need administrative rights to access the application.

**1** Open a web browser, and then type the printer IP address in the address field.

### Notes:

- View the printer IP address on the printer home screen. The IP address appears as four sets of numbers separated by periods, such as 123.123.123.123.
- If you are using a proxy server, then temporarily disable it to load the web page correctly.

**2** Click **Apps > QR Code Generator > Configure**.

**3** Do either of the following:

- Select a default QR code value.
- Type a QR code value.

**4** Apply the changes.

## Configuring Eco-Settings

**Note:** This application is supported only in some printer models. For more information, see [“Supported applications” on page 21](#).

**1** From the home screen, touch **Eco-Settings**.

**2** Configure the Eco-Mode settings or schedule a power-saving mode.

## Using Customer Support

**Note:** This application is supported only in some printer models. For more information, see [“Supported applications” on page 21](#).

**1** From the home screen, touch **Customer Support**.

**2** Print or e-mail the information.

**Note:** For information on configuring the application settings, see the *Customer Support Administrator’s Guide*.

## Creating a Cloud Connector profile

**Note:** This application is available only in certain country or region. For more information, contact your Lexmark representative.

**1** From the home screen, touch **Cloud Connector**.

**2** Select a cloud service provider.

- 3 Touch **Create** or .
- 4 Type a unique profile name.  
**Note:** We recommend creating a PIN to protect the profile.
- 5 Touch **OK**, and then take note of the authorization code.  
**Note:** The authorization code is valid only for 24 hours.
- 6 Open a web browser, and then go to <https://lexmark.cloud-connect.co>.
- 7 Click **Next**, and then accept the Terms of Use.
- 8 Enter the authorization code, and then click **Connect**.
- 9 Log in to your cloud service provider account.
- 10 Grant permissions.  
**Note:** To complete the authorization process, open the profile within 72 hours.

## Managing bookmarks

### Creating bookmarks

Use bookmarks to print frequently accessed documents that are stored in servers or on the web.

- 1 Open a web browser, and then type the printer IP address in the address field.

**Notes:**

- View the printer IP address on the printer home screen. The IP address appears as four sets of numbers separated by periods, such as 123.123.123.123.
- If you are using a proxy server, then temporarily disable it to load the web page correctly.

- 2 Click **Bookmarks > Add Bookmark**, and then type a bookmark name.
- 3 Select an Address protocol type, and then do one of the following:
  - For HTTP and HTTPS, type the URL that you want to bookmark.
  - For HTTPS, make sure to use the host name instead of the IP address. For example, type **myWebsite.com/sample.pdf** instead of typing **123.123.123.123/sample.pdf**. Make sure that the host name also matches the Common Name (CN) value in the server certificate. For more information on obtaining the CN value in the server certificate, see the help information for your web browser.
  - For FTP, type the FTP address. For example, **myServer/myDirectory**. Enter the FTP port. Port 21 is the default port for sending commands.
  - For SMB, type the network folder address. For example, **myServer/myShare/myFile.pdf**. Type the network domain name.
  - If necessary, select the Authentication type for FTP and SMB.

To limit access to the bookmark, enter a PIN.

**Note:** The application supports the following file types: PDF, JPEG, TIFF, and HTML-based web pages. Other file types such as DOCX and XLXS are supported in some printer models.

- 4 Click **Save**.

## Creating folders

- 1 Open a web browser, and then type the printer IP address in the address field.

**Notes:**

- View the printer IP address on the printer home screen. The IP address appears as four sets of numbers separated by periods, such as 123.123.123.123.
- If you are using a proxy server, then temporarily disable it to load the web page correctly.

- 2 Click **Bookmarks** > **Add Folder**, and then type a folder name.

**Note:** To limit access to the folder, enter a PIN.

- 3 Click **Save**.

**Note:** You can create folders or bookmarks inside a folder. To create a bookmark, see [“Creating bookmarks” on page 25](#).

## Managing contacts

### Adding contacts

- 1 Open a web browser, and then type the printer IP address in the address field.

**Notes:**

- View the printer IP address on the printer home screen. The IP address appears as four sets of numbers separated by periods, such as 123.123.123.123.
- If you are using a proxy server, then temporarily disable it to load the web page correctly.

- 2 Click **Address Book**.

- 3 From the Contacts section, add a contact.

**Note:** You can assign the contact to one or more groups.

- 4 If necessary, specify a login method to allow application access.

- 5 Apply the changes.

### Adding groups

- 1 Open a web browser, and then type the printer IP address in the address field.

**Notes:**

- View the printer IP address on the printer home screen. The IP address appears as four sets of numbers separated by periods, such as 123.123.123.123.
- If you are using a proxy server, then temporarily disable it to load the web page correctly.

- 2 Click **Address Book**.

**3** From the Contact Groups section, add a group name.

**Note:** You can assign one or more contacts to the group.

**4** Apply the changes.

## Editing contacts or groups

**1** Open a web browser, and then type the printer IP address in the address field.

**Notes:**

- View the printer IP address on the printer home screen. The IP address appears as four sets of numbers separated by periods, such as 123.123.123.123.
- If you are using a proxy server, then temporarily disable it to load the web page correctly.

**2** Click **Address Book**.

**3** Do either of the following:

- From the Contacts section, click a contact name, and then edit the information.
- From the Contact Groups section, click a group name, and then edit the information.

**4** Apply the changes.

## Deleting contacts or groups

**1** Open a web browser, and then type the printer IP address in the address field.

**Notes:**

- View the printer IP address on the printer home screen. The IP address appears as four sets of numbers separated by periods, such as 123.123.123.123.
- If you are using a proxy server, then temporarily disable it to load the web page correctly.

**2** Click **Address Book**.

**3** Do either of the following:

- From the Contacts section, select a contact that you want to delete.
- From the Contact Groups section, select a group name that you want to delete.

# Setting up and using the accessibility features

## Enabling Magnification mode

- 1 From the control panel, press and hold the **5** key until you hear a voice message.
- 2 Select **Magnification mode**.
- 3 Select **OK**.

For more information on navigating a magnified screen, see [“Navigating the screen using gestures” on page 28](#).

## Activating Voice Guidance

### From the control panel

- 1 Press and hold the **5** key until you hear a voice message.
- 2 Select **OK**.

### From the keyboard

- 1 Press and hold the **5** key until you hear a voice message.
- 2 Press **Tab** to navigate the focus cursor to the OK button, and then press **Enter**.

### Notes:

- Voice Guidance is also activated when you insert headphones into the headphone jack.
- To adjust the volume, use the volume buttons at the bottom part of the control panel.

## Adjusting the Voice Guidance speech rate

- 1 From the home screen, select **Settings** > **Device** > **Accessibility** > **Speech Rate**.
- 2 Select the speech rate.

## Navigating the screen using gestures

### Notes:

- The gestures are applicable only when Voice Guidance is activated.
- Enable Magnification to use the zoom and pan gestures.
- Use a physical keyboard to type characters and adjust certain settings.

Gesture	Function
Double-tap	Select an option or item on the screen.
Triple-tap	Zoom in or zoom out text and images.



Gesture	Function
Swipe right or swipe down	Move to the next item on the screen.
Swipe left or swipe up	Move to the previous item on the screen.
Pan	Access parts of the zoomed image that are beyond the limits of the screen. <b>Note:</b> This gesture requires the use of two fingers to drag across a zoomed image.
Swipe up then left	Exit an application and return to the home screen.
Swipe down then left	<ul style="list-style-type: none"><li>• Cancel a job.</li><li>• Go back to the previous setting.</li><li>• Exit the screen that appears without changing any setting or value.</li></ul>
Swipe up then down	Repeat a spoken prompt.

## Using the keyboard on the display

Do one or more of the following:

- Drag a finger over the key to announce the character.
- Lift the finger to enter or type the character in the field.
- Select **Backspace** to delete characters.
- To hear the content in the input field, select **Tab**, and then select **Shift + Tab**.

## Enabling spoken passwords or personal identification numbers

- 1 From the home screen, select **Settings** > **Device** > **Accessibility** > **Speak Passwords/PINs**.
- 2 Enable the setting.

# Loading paper and specialty media

## Setting the size and type of the specialty media

The trays automatically detect the size of plain paper. For specialty media like labels, card stock, or envelopes, do the following:

- 1 From the home screen, navigate to:  
**Settings > Paper > Tray Configuration > Paper Size/Type** > select a paper source
- 2 Set the size and type of the specialty media.

## Configuring Universal paper settings

- 1 From the home screen, touch **Settings > Paper > Media Configuration > Universal Setup**.
- 2 Configure the settings.

## Loading the 550-sheet tray

**⚠ CAUTION—POTENTIAL INJURY:** To reduce the risk of equipment instability, load each tray separately. Keep all other trays closed until needed.

- 1 Remove the tray.

**Note:** To avoid paper jams, do not remove trays while the printer is busy.



- 2 Adjust the guides to match the size of the paper that you are loading.

**Note:** Use the indicators on the bottom of the tray to position the guides.

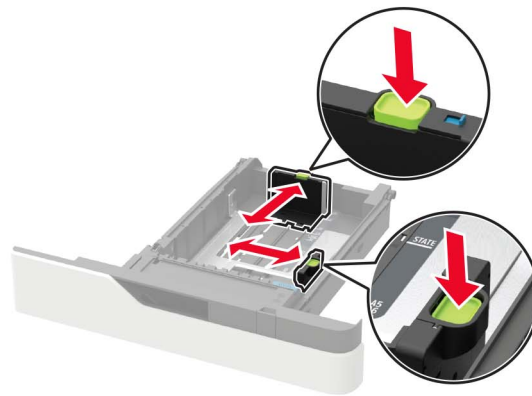
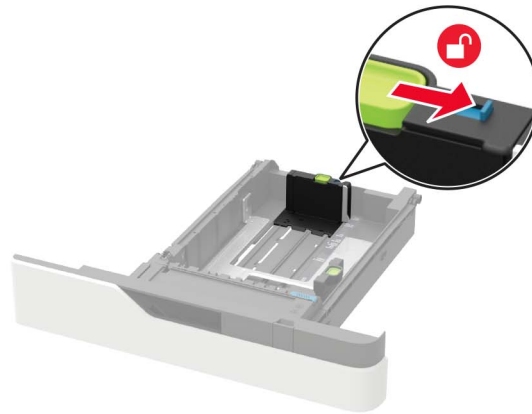

**3** Flex, fan, and align the paper edges before loading.

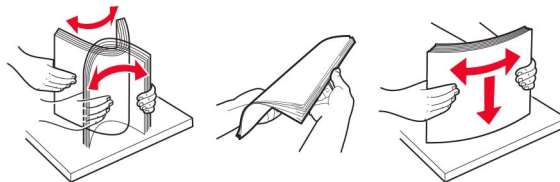

**4** Load the paper stack with the printable side facedown, and then make sure that the side guides fit snugly against the paper.



- Do not slide paper into the tray.
- To avoid paper jams, make sure that the stack height is below the maximum paper fill indicator.



- Load letterhead depending on whether an optional staple finisher is installed or not.

Without an optional staple finisher	With an optional staple finisher
<p>One-sided printing</p>	<p>One-sided printing</p>
<p>Two-sided printing</p>	<p>Two-sided printing</p>

- When loading prepunched paper, make sure that the holes on the long edge of the paper are against the right side of the tray.

One-sided printing	Two-sided printing

- Load envelopes with the flap side up and against the left side of the tray.

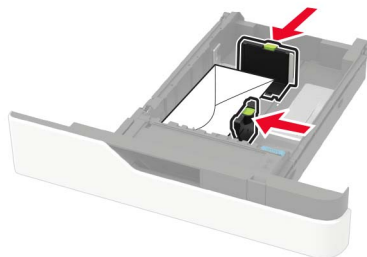

**Warning—Potential Damage:** Do not use envelopes with stamps, clasps, snaps, windows, coated linings, or self-stick adhesives.

- 5 Insert the tray.
- 6 From the control panel, set the paper size and paper type to match the paper loaded.

## Loading the 2100-sheet tray

**CAUTION—TIPPING HAZARD:** To reduce the risk of equipment instability, load each tray separately. Keep all other trays closed until needed.

- 1 Pull out the tray.
- 2 Adjust the guides.

### Loading A5-size paper

- a Pull up and slide the width guide to the position for A5.

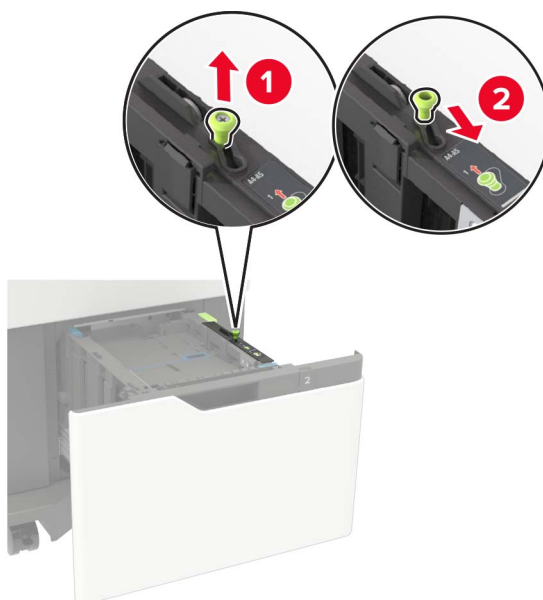

- b** Squeeze and slide the length guide to the position for A5 until it *clicks* into place.

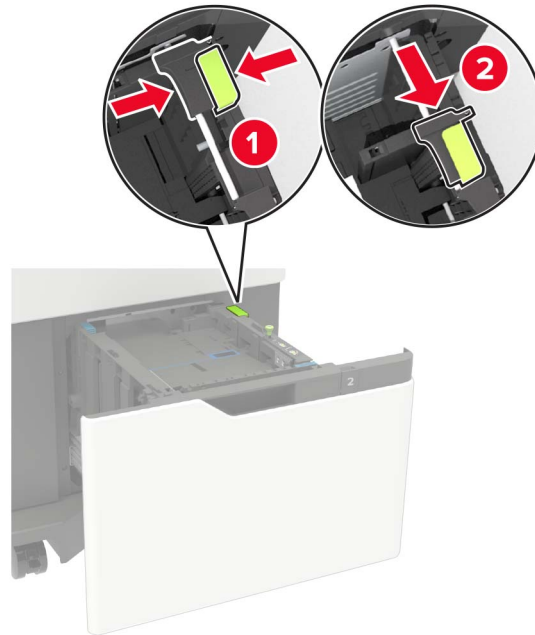

- c** Remove the A5 length guide from its holder.

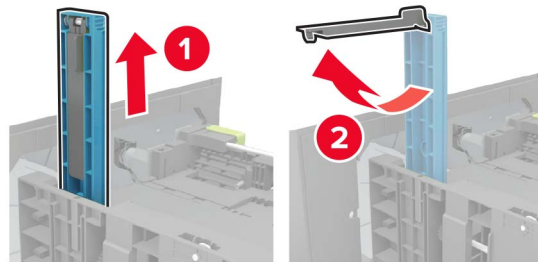

- d** Insert the guide into its designated slot, and then press until it *clicks* into place.

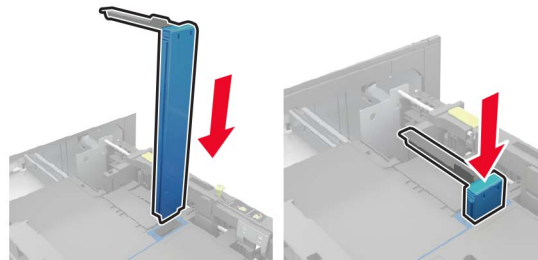

## Loading A4-, letter-, legal-, Oficio-, and folio-size paper

- a Pull up and slide the width guide to the correct position for the size of the paper being loaded.



- b If the A5 length guide is still attached, then remove it. If the guide is not attached, then proceed to [step d on page 36](#).

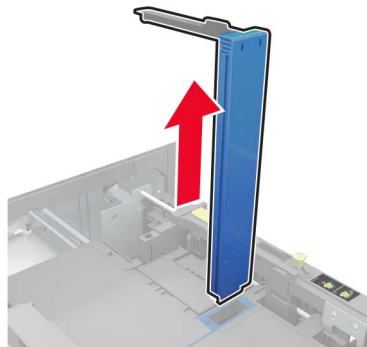

- c Place the A5 length guide in its holder.

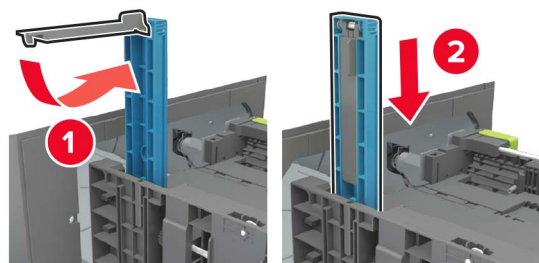

- d Squeeze, and then slide the length guide to the correct position for the size of the paper being loaded.



- 3 Flex, fan, and align the paper edges before loading.

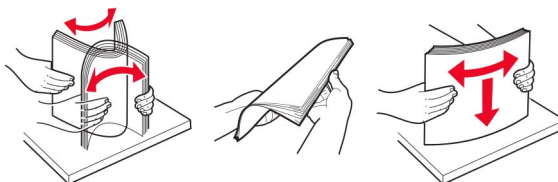

- 4 Load the paper stack with the printable side facedown.

- Load letterhead depending on whether an optional staple finisher is installed or not.

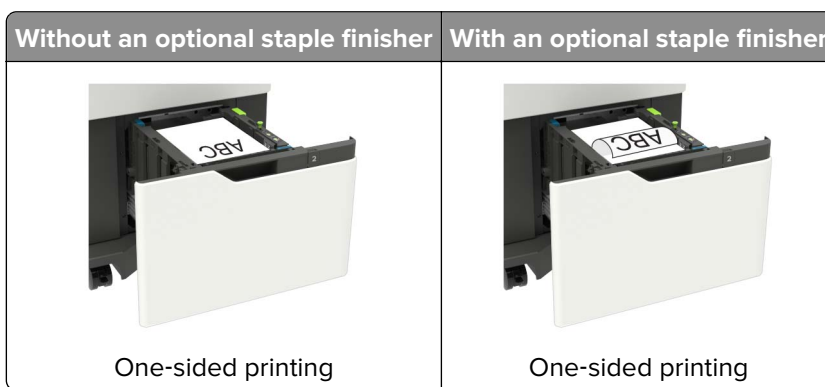



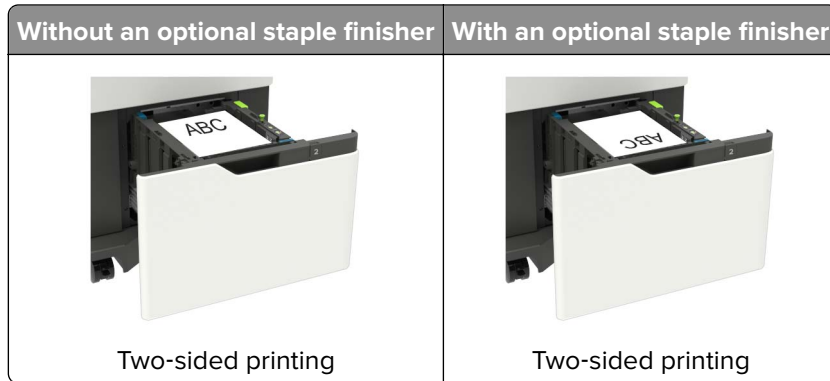

- When loading prepunched paper, make sure that the holes on the long edge of the paper are against the right side of the tray.

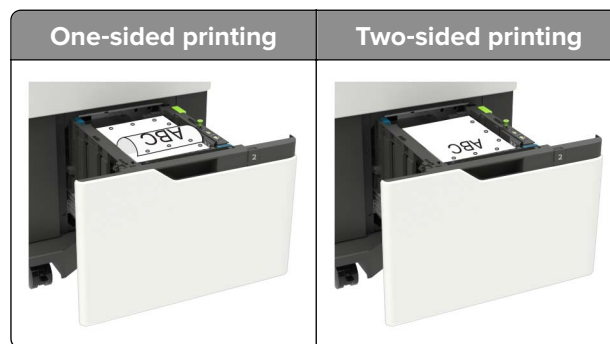

**5** Insert the tray.

**Note:** Press down the paper stack while inserting the tray.

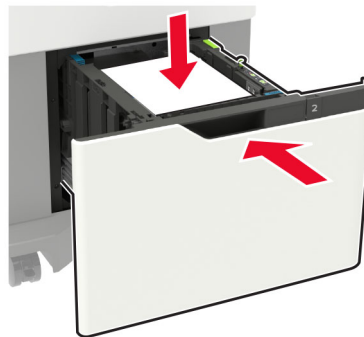

**6** From the control panel, set the paper size and paper type to match the paper loaded.

## Loading the multipurpose feeder

1 Open the multipurpose feeder.



2 Adjust the guide to match the size of the paper that you are loading.



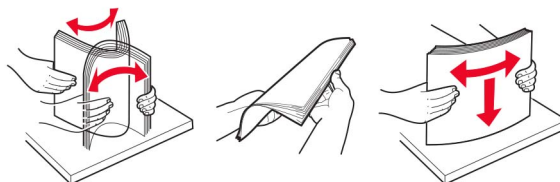

3 Flex, fan, and align the paper edges before loading.



4 Load paper with the printable side faceup.

- Load letterhead depending on whether an optional staple finisher is installed or not.

Without an optional staple finisher	With an optional staple finisher
	
One-sided printing	One-sided printing

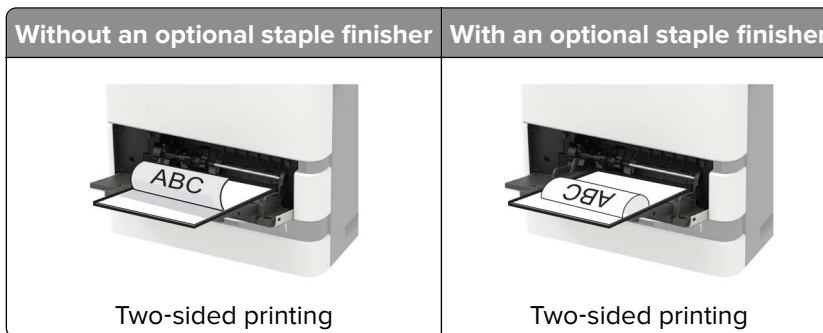

- When loading prepunched paper, make sure that the holes on the long edge of the paper are against the right side of the paper guide.

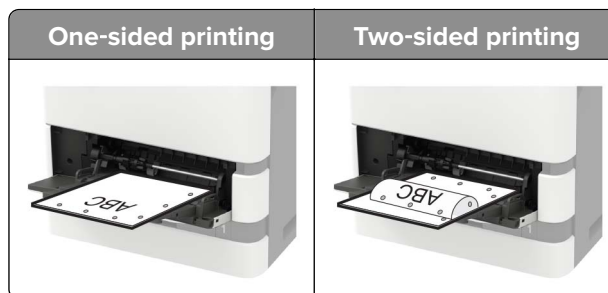

- Load envelopes with the flap side down and against the left side of the paper guide.

**Warning—Potential Damage:** Do not use envelopes with stamps, clasps, snaps, windows, coated linings, or self-stick adhesives.

- 5 From the control panel, set the paper size and paper type to match the paper loaded.

## Linking trays

- 1 From the home screen, touch **Settings** > **Paper** > **Tray Configuration** > select a paper source.
- 2 Set the same paper size and paper type for the trays that you are linking.
- 3 From the home screen, touch **Settings** > **Device** > **Maintenance** > **Configuration Menu** > **Tray Configuration** > **Tray Linking**.
- 4 Touch **Automatic**.

To unlink trays, make sure that no trays have the same paper size and paper type settings.

**Warning—Potential Damage:** The temperature of the fuser varies according to the specified paper type. To avoid printing issues, match the paper type setting in the printer with the paper loaded in the tray.

# Paper support

## Supported paper sizes

### Paper sizes supported by the printer

Paper size	Standard or optional 550-sheet tray	Optional 2100-sheet tray	Multipurpose feeder	Two-sided printing
<b>A4</b> 210 x 297 mm (8.3 x 11.7 in.)	✓	✓	✓	✓
<b>A5 LEF<sup>1</sup></b> 210 x 148 mm (8.3 x 5.8 in.)	✓	✓	✓	✓
<b>A5 SEF</b> 148 x 210 mm (5.8 x 8.3 in.)	✓	x	✓	x
<b>A6</b> 105 x 148 mm (4.1 x 5.8 in.)	✓	x	✓	✓
<b>JIS B5</b> 182 x 257 mm (7.2 x 10.1 in.)	✓	x	✓	✓
<b>Oficio (Mexico)</b> 216 x 340 mm (8.5 x 13.4 in.)	✓	✓	✓	✓
<b>Statement</b> 140 x 216 mm (5.5 x 8.5 in.)	✓	x	✓	✓
<b>Executive</b> 184 x 267 mm (7.3 x 10.5 in.)	✓	x	✓	✓
<b>Letter</b> 216 x 279 mm (8.5 x 11 in.)	✓	✓	✓	✓
<b>Legal</b> 216 x 356 mm (8.5 x 14 in.)	✓	✓	✓	✓
<b>Folio</b> 216 x 330 mm (8.5 x 13 in.)	✓	✓	✓	✓
<b>Universal</b> 105 x 148 mm (4.1 x 5.8 in.) to 216 x 356 mm (8.5 x 14 in.)	✓	x	✓	✓
<b>7 3/4 Envelope (Monarch)<sup>3</sup></b> 98 x 191 mm (3.9 x 7.5 in.)	✓	x	✓	x

<sup>1</sup> A5 long edge feed (LEF) is recommended over A5 short edge feed (SEF).

<sup>2</sup> Envelopes wider than 101.6 mm (4.5 in.) may crease. This paper type must be tested for acceptability.

Paper size	Standard or optional 550-sheet tray	Optional 2100-sheet tray	Multipurpose feeder	Two-sided printing
<b>9 Envelope</b> 98 x 225 mm (3.9 x 8.9 in.)	✓	X	✓	X
<b>10 Envelope<sup>2</sup></b> 105 x 241 mm (4.1 x 9.5 in.)	✓	X	✓	X
<b>DL Envelope<sup>2</sup></b> 110 x 220 mm (4.3 x 8.7 in.)	✓	X	✓	X
<b>C5 Envelope<sup>2</sup></b> 162 x 229 mm (6.4 x 9 in.)	✓	X	✓	X
<b>B5 Envelope<sup>2</sup></b> 176 x 250 mm (6.9 x 9.8 in.)	✓	X	✓	X
<b>Other Envelope<sup>2</sup></b> 98.4 x 162 mm (3.9 x 6.4 in.) to 176 x 250 mm (6.9 x 9.8 in.)	✓	X	✓	X

<sup>1</sup> A5 long edge feed (LEF) is recommended over A5 short edge feed (SEF).

<sup>2</sup> Envelopes wider than 101.6 mm (4.5 in.) may crease. This paper type must be tested for acceptability.

## Paper sizes supported by the output options or finishers

Paper size	Offset stacker	4-bin mailbox	Staple finisher		Staple, hole punch finisher		
			Stack	Staple	Stack	Staple	Hole punch
<b>A4</b> 210 x 297 mm (8.3 x 11.7 in.)	✓	✓	✓	✓	✓	✓	✓
<b>A5 LEF</b> 210 x 148 mm (8.3 x 5.8 in.)	✓	✓	✓	✓	✓	✓	X
<b>A5 SEF</b> 148 x 210 mm (5.8 x 8.3 in.)	✓	✓	✓	X	✓	X	X
<b>A6</b> 105 x 148 mm (4.1 x 5.8 in.)	✓	✓	X	X	X	X	X
<b>JIS B5</b> 182 x 257 mm (7.2 x 10.1 in.)	✓	✓	✓	X	✓	X	X
<b>Oficio (Mexico)</b> 216 x 340 mm (8.5 x 13.4 in.)	✓	✓	✓	✓	✓	✓	✓

Paper size	Offset stacker	4-bin mailbox	Staple finisher		Staple, hole punch finisher		
			Stack	Staple	Stack	Staple	Hole punch
<b>Statement</b> 140 x 216 mm (5.5 x 8.5 in.)	✓	✓	✓	X	✓	X	X
<b>Executive</b> 184 x 267 mm (7.3 x 10.5 in.)	✓	✓	✓	X	✓	X	X
<b>Letter</b> 216 x 279 mm (8.5 x 11 in.)	✓	✓	✓	✓	✓	✓	✓
<b>Legal</b> 216 x 356 mm (8.5 x 14 in.)	✓	✓	✓	✓	✓	✓	X
<b>Folio</b> 216 x 330 mm (8.5 x 13 in.)	✓	✓	✓	✓	✓	✓	✓
<b>Universal</b> 105 x 148 mm (4.1 x 5.8 in.) to 216 x 356 mm (8.5 x 14 in.)	✓	✓	X	X	X	X	X
<b>7 3/4 Envelope (Monarch)</b> 98 x 191 mm (3.9 x 7.5 in.)	✓	X	X	X	X	X	X
<b>9 Envelope</b> 98 x 225 mm (3.9 x 8.9 in.)	✓	X	X	X	X	X	X
<b>10 Envelope</b> 105 x 241 mm (4.1 x 9.5 in.)	✓	X	X	X	X	X	X
<b>DL Envelope</b> 110 x 220 mm (4.3 x 8.7 in.)	✓	X	X	X	X	X	X
<b>C5 Envelope</b> 162 x 229 mm (6.4 x 9 in.)	✓	X	X	X	X	X	X
<b>B5 Envelope</b> 176 x 250 mm (6.9 x 9.8 in.)	✓	X	X	X	X	X	X

Paper size	Offset stacker	4-bin mailbox	Staple finisher		Staple, hole punch finisher		
			Stack	Staple	Stack	Staple	Hole punch
<b>Other Envelopes</b> 98.4 x 162 mm (3.9 x 6.4 in.) to 176 x 250 mm (6.9 x 9.8 in.)	✓	X	X	X	X	X	X

## Supported paper types

### Paper types supported by the printer

Paper type	Standard or optional 550-sheet tray	Optional 2100-sheet tray	Multipurpose feeder	Two-sided printing
Plain paper	✓	✓	✓	✓
Card stock	✓	X	✓	✓
Transparency <sup>1</sup>	✓	X	✓	X
Labels	✓	X	✓	X
Bond	✓	✓	✓	✓
Envelope	✓	X	✓	X
Rough envelope	✓	X	✓	X
Letterhead	✓	✓	✓	✓
Preprinted	✓	✓	✓	✓
Colored paper	✓	X	✓	✓
Light	✓	X	✓	✓
Heavy	✓	X	✓	✓
Rough/Cotton	✓	X	✓	✓
Custom type [x]	✓	X	✓	✓

<sup>1</sup> To prevent transparencies from sticking together, print up to 20 pages only. Print the succeeding pages after three minutes.

## Paper types supported by the output options or finishers

Paper type	Offset stacker	4-bin mailbox	Staple finisher		Staple, hole punch finisher		
			Stack	Staple	Stack	Staple	Hole punch
Plain paper	✓	✓	✓	✓	✓	✓	✓
Card stock	✓	X	X	X	X	X	X
Transparencies	✓	X	✓	X	✓	X	X
Labels	✓	X	X	X	X	X	X
Bond	✓	✓	✓	✓	✓	✓	✓
Envelope	✓	X	X	X	X	X	X
Rough envelope	✓	X	X	X	X	X	X
Letterhead	✓	✓	✓	✓	✓	✓	✓
Preprinted	✓	✓	✓	✓	✓	✓	✓
Colored paper	✓	X	X	X	X	X	X
Light	✓	X	X	X	X	X	X
Heavy	✓	X	X	X	X	X	X
Rough/Cotton	✓	X	X	X	X	X	X
Custom type [x]	✓	X	X	X	X	X	X

## Supported paper weights

### Paper weights supported by the printer

Paper type and weight	Standard or optional 550-sheet tray	Optional 2100-sheet tray	Multipurpose feeder	Two-sided printing
Plain paper or Bond <sup>1</sup> 60–176 g/m <sup>2</sup> grain long (16–47-lb bond)	✓	✓	✓	✓

<sup>1</sup> Grain short is preferred for paper over 176 g/m<sup>2</sup> (47 lb).

<sup>2</sup> Pressure-sensitive area must enter the printer first.

<sup>3</sup> 28-lb bond envelopes are limited to 25% cotton content.



Paper type and weight	Standard or optional 550-sheet tray	Optional 2100-sheet tray	Multipurpose feeder	Two-sided printing
<b>Card stock</b> 203 g/m <sup>2</sup> grain long (125-lb bond)	✓	X	✓	✓
<b>Card stock</b> 199 g/m <sup>2</sup> grain long (110-lb bond)	✓	X	✓	✓
<b>Card stock</b> 176 g/m <sup>2</sup> grain long (65-lb bond)	✓	X	✓	✓
<b>Transparency</b> 138–146 g/m <sup>2</sup> grain long (37–39-lb bond)	✓	X	✓	X
<b>Paper labels</b> 180 g/m <sup>2</sup> (48-lb bond)	✓	X	✓	✓
<b>Integrated forms<sup>2</sup></b> 140–175 g/m <sup>2</sup> (37–47-lb bond)	✓	X	✓	✓
<b>Integrated forms</b> 75–135 g/m <sup>2</sup> (20–36-lb bond)	✓	X	✓	✓
<b>Envelopes<sup>3</sup></b> 60–105 g/m <sup>2</sup> (16–28-lb bond)	✓	X	✓	✓

<sup>1</sup> Grain short is preferred for paper over 176 g/m<sup>2</sup> (47 lb).

<sup>2</sup> Pressure-sensitive area must enter the printer first.

<sup>3</sup> 28-lb bond envelopes are limited to 25% cotton content.

## Paper weights supported by the output options or finishers

Paper type and weight	Offset stacker	4-bin mailbox	Staple finisher		Staple, hole punch finisher		
			Stack	Staple	Stack	Staple	Hole punch
<b>Plain paper or Bond</b> 60–176 g/m <sup>2</sup> grain long (16–47-lb bond)	✓	X	✓	X	✓	X	X
<b>Plain paper or Bond</b> 60–90 g/m <sup>2</sup> grain long (16–24-lb bond)	✓	✓	✓	✓	✓	✓	✓

Paper type and weight	Offset stacker	4-bin mailbox	Staple finisher		Staple, hole punch finisher		
			Stack	Staple	Stack	Staple	Hole punch
<b>Card stock</b> 203 g/m <sup>2</sup> grain long (125-lb bond)	✓	X	✓	X	✓	X	X
<b>Card stock</b> 199 g/m <sup>2</sup> grain long (110-lb bond)	✓	X	✓	X	✓	X	X
<b>Card stock</b> 176 g/m <sup>2</sup> grain long (65-lb bond)	✓	X	X	X	X	X	X
<b>Card stock</b> 163 g/m <sup>2</sup> grain long (90-lb bond)	✓	X	✓	X	✓	X	X
<b>Transparency</b> 138–146 g/m <sup>2</sup> grain long (37– 39-lb bond)	✓	X	✓	X	✓	X	X
<b>Paper labels</b> 180 g/m <sup>2</sup> (48-lb bond)	✓	X	X	X	X	X	X
<b>Integrated forms</b> 140–175 g/m <sup>2</sup> (37–47-lb bond)	✓	X	X	X	X	X	X
<b>Integrated forms</b> 75–135 g/m <sup>2</sup> (20–36-lb bond)	✓	X	X	X	X	X	X
<b>Envelopes</b> 60–105 g/m <sup>2</sup> (16–28-lb bond)	✓	X	X	X	X	X	X

# Printing

## Printing from a computer

**Note:** For labels, card stock, and envelopes, set the paper size and type in the printer before printing the document.

- 1 From the document that you are trying to print, open the Print dialog.
- 2 If necessary, adjust the settings.
- 3 Print the document.

## Printing from a mobile device

Printing from a mobile device using Lexmark Mobile Print

### Printing from a mobile device using Lexmark Mobile Print

Lexmark™ Mobile Print allows you to send documents and images directly to a supported Lexmark printer.

- 1 Open the document, and then send or share the document to Lexmark Mobile Print.



**Note:** Some third-party applications may not support the send or share feature. For more information, see the documentation that came with the application.

- 2 Select a printer.
- 3 Print the document.

### Printing from a mobile device using Mopria Print Service

Mopria® Print Service is a mobile printing solution for mobile devices running on Android™ version 5.0 or later. It allows you to print directly to any Mopria-certified printer.

**Note:** Make sure that you download the Mopria Print Service application from the Google Play™ store and enable it in the mobile device.

- 1 From your Android mobile device, launch a compatible application or select a document from your file manager.
- 2 Tap  > **Print**.
- 3 Select a printer, and then adjust the settings, if necessary.
- 4 Tap .

## Printing from a mobile device using AirPrint

The AirPrint software feature is a mobile printing solution that allows you to print directly from Apple devices to an AirPrint-certified printer.

### Notes:

- Make sure that the Apple device and the printer are connected to the same network. If the network has multiple wireless hubs, then make sure that both devices are connected to the same subnet.
- This application is supported only in some Apple devices.

**1** From your mobile device, select a document from your file manager or launch a compatible application.

**2** Tap  > **Print**.

**3** Select a printer, and then adjust the settings, if necessary.

**4** Print the document.



## Printing from a mobile device using Wi-Fi Direct®

Wi-Fi Direct® is a printing service that lets you print to any Wi-Fi Direct-ready printer.

**Note:** Make sure that the mobile device is connected to the printer wireless network. For more information, see [“Connecting a mobile device to the printer” on page 171](#).

**1** From your mobile device, launch a compatible application or select a document from your file manager.

**2** Depending on your mobile device, do one of the following:

- Tap  > **Print**.
- Tap  > **Print**.
- Tap  > **Print**.

**3** Select a printer, and then adjust the settings, if necessary.

**4** Print the document.

## Printing from a flash drive

- 1 Insert the flash drive.



### Notes:

- If you insert the flash drive when an error message appears, then the printer ignores the flash drive.
- If you insert the flash drive while the printer is processing other print jobs, then **Busy** appears on the display.

- 2 From the display, touch the document that you want to print.

If necessary, configure other print settings.

- 3 Send the print job.

To print another document, touch **USB Drive**.

**Warning—Potential Damage:** To avoid loss of data or printer malfunction, do not touch the flash drive or the printer in the area shown while actively printing, reading, or writing from the memory device.



## Supported flash drives and file types

### Flash drives

- Lexar JumpDrive S70 (16GB and 32GB)
- SanDisk Cruzer (16GB and 32GB)
- PNY Attache (16GB and 32GB)

### Notes:

- The printer supports high-speed USB flash drives with full-speed standard.
- USB flash drives must support the File Allocation Table (FAT) system.

### File types

#### Documents

- PDF (version 1.7 or earlier)
- HTML
- XPS
- Microsoft file formats (.doc, .docx, .xls, .xlsx, .ppt, .pptx)

#### Images

- .dcx
- .gif
- .JPEG or .jpg
- .bmp
- .pcx
- .TIFF or .tif
- .png

## Configuring confidential jobs

- 1 From the control panel, navigate to:  
**Settings > Security > Confidential Print Setup**
- 2 Configure the settings.

Use	To
Max Invalid PIN	Set the number of times an invalid PIN can be entered. <b>Note:</b> When the limit is reached, the print jobs for that user name are deleted.
Confidential Job Expiration	Set the expiration time for confidential print jobs. <b>Note:</b> Confidential held jobs are stored in the printer until they are released or deleted manually.
Repeat Job Expiration	Set the expiration time for a repeat print job. <b>Note:</b> Repeat held jobs are stored in the printer memory for reprinting.

Use	To
Verify Job Expiration	Set the expiration time that the printer prints a copy before printing the remaining copies. <b>Note:</b> Verify jobs print one copy to check if it is satisfactory before printing the remaining copies.
Reserve Job Expiration	Set the expiration time that the printer stores print jobs. <b>Note:</b> Reserve held jobs are automatically deleted after printing.
Require All Jobs to be Held	Set the printer to hold all print jobs.
Keep duplicate documents	Set the printer to print all documents with the same file name.

## Printing confidential and other held jobs

### For Windows users

- 1 With a document open, click **File > Print**.
- 2 Select a printer, and then click **Properties, Preferences, Options, or Setup**.
- 3 Click **Print and Hold**.
- 4 Select **Use Print and Hold**, and then assign a user name.
- 5 Select the print job type (Confidential, Repeat, Reserve, or Verify).  
If you select **Confidential**, then secure the print job with a personal identification number (PIN).
- 6 Click **OK** or **Print**.
- 7 From the printer home screen, release the print job.
  - For confidential print jobs, touch **Held jobs** > select your user name > **Confidential** > enter the PIN > select the print job > configure the settings > **Print**.
  - For other print jobs, touch **Held jobs** > select your user name > select the print job > configure the settings > **Print**.

### For Macintosh users

#### Using AirPrint

- 1 With a document open, choose **File > Print**.
- 2 Select a printer, and then from the drop-down menu following the Orientation menu, choose **PIN Printing**.
- 3 Enable **Print with PIN**, and then enter a four-digit PIN.
- 4 Click **Print**.
- 5 From the printer home screen, release the print job. Touch **Held jobs** > select your computer name > **Confidential** > enter the PIN > select the print job > **Print**.

### Using the print driver

- 1 With a document open, choose **File > Print**.
- 2 Select a printer, and then from the drop-down menu following the Orientation menu, choose **Print and Hold**.
- 3 Choose **Confidential Print**, and then enter a four-digit PIN.
- 4 Click **Print**.
- 5 From the printer home screen, release the print job. Touch **Held jobs > select your computer name > Confidential > select the print job > enter the PIN > Print**.

## Printing from a Cloud Connector profile

- 1 From the home screen, touch **Cloud Connector**.
- 2 Select a cloud service provider, and then select a profile.  
**Note:** For more information on creating a Cloud Connector profile, see [“Creating a Cloud Connector profile” on page 24](#).
- 3 Touch **Print**, and then select a file.  
If necessary, change the settings.  
**Note:** Make sure to select a supported file.
- 4 Print the document.

## Printing a font sample list

- 1 From the home screen, touch **Settings > Reports > Print > Print Fonts**.
- 2 Touch **PCL Fonts** or **PS Fonts**.

## Printing a directory list

From the home screen, touch **Settings > Reports > Print > Print Directory**.

## Canceling a print job

### From the printer control panel

- 1 From the home screen, touch **Job Queue**.  
**Note:** You can also access this setting by touching the top section of the home screen.
- 2 Select the job to cancel.



**From the computer**

- 1** Depending on the operating system, do either of the following:
  - Open the printers folder, and then select your printer.
  - From the System Preferences in the Apple menu, navigate to your printer.
- 2** Select the job to cancel.

# Copying

## Using the automatic document feeder and scanner glass

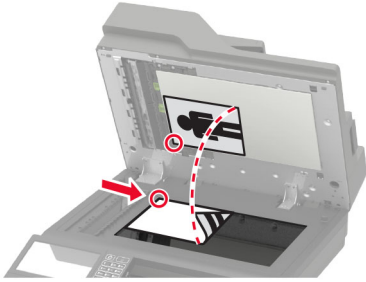
Automatic document feeder (ADF)	Scanner glass
 <ul style="list-style-type: none"> <li>• Use the ADF for multiple-page or two-sided documents.</li> <li>• Load an original document faceup. For multiple-page documents, make sure to align the leading edge before loading.</li> <li>• Make sure to adjust the ADF guides to match the width of the paper that you are loading.</li> </ul>	 <ul style="list-style-type: none"> <li>• Use the scanner glass for single-page documents, book pages, small items (such as postcards or photos), transparencies, photo paper, or thin media (such as magazine clippings).</li> <li>• Place the document facedown in the corner with the arrow.</li> </ul>

## Making copies

- 1 Load an original document into the ADF tray or on the scanner glass.

**Note:** To avoid a cropped image, make sure that the original document and output have the same paper size.

- 2 From the home screen, touch **Copy**, and then specify the number of copies.  
If necessary, adjust the copy settings.
- 3 Copy the document.

**Note:** To make a quick copy, from the control panel, press .

## Copying photos

- 1 Place a photo on the scanner glass.
- 2 From the home screen, touch **Copy** > **Content** > **Content Type** > **Photo**.
- 3 Touch **Content Source**, and then select the setting that best matches the original photo.
- 4 Copy the photo.

## Copying on letterhead

- 1 Load an original document into the ADF tray or on the scanner glass.
- 2 From the home screen, touch **Copy** > **Copy From** > select the size of the original document.
- 3 Touch **Copy To**, and then select the paper source that contains the letterhead.  
If you loaded the letterhead into the multipurpose feeder, then navigate to:  
**Copy To** > **Multipurpose Feeder** > select a paper size > **Letterhead**
- 4 Copy the document.

## Copying on both sides of the paper

- 1 Load an original document into the ADF tray or on the scanner glass.
- 2 From the home screen, touch **Copy** > **Sides**.
- 3 Adjust the settings.
- 4 Copy the document.

## Reducing or enlarging copies

- 1 Load an original document into the ADF tray or on the scanner glass.
- 2 From the home screen, navigate to:  
**Copy** > **Scale** > specify a scale value  
**Note:** Changing the size of the original document or output after setting Scale restores the scale value to Auto.
- 3 Copy the document.

## Collating copies

- 1 Load an original document into the ADF tray or on the scanner glass.
- 2 From the home screen, touch **Copy** > **Collate** > **On** [1,2,1,2,1,2].
- 3 Copy the document.

## Placing separator sheets between copies

- 1 Load an original document into the ADF tray or on the scanner glass.
- 2 From the home screen, touch **Copy** > **Separator Sheets**.
- 3 Adjust the settings.
- 4 Send the copy job.

## Copying multiple pages onto a single sheet

- 1 Load an original document into the ADF tray or on the scanner glass.
- 2 From the home screen, touch **Copy** > **Pages per Side**.
- 3 Adjust the settings.
- 4 Copy the document.

## Creating a copy shortcut

- 1 From the home screen, touch **Copy**.
- 2 Configure the settings, and then touch .
- 3 Create a shortcut.

## E-mailing

### Using the automatic document feeder and scanner glass

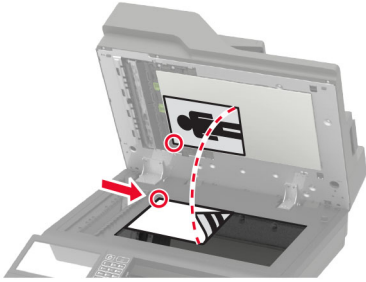
Automatic document feeder (ADF)	Scanner glass
 <ul style="list-style-type: none"> <li>• Use the ADF for multiple-page or two-sided documents.</li> <li>• Load an original document faceup. For multiple-page documents, make sure to align the leading edge before loading.</li> <li>• Make sure to adjust the ADF guides to match the width of the paper that you are loading.</li> </ul>	 <ul style="list-style-type: none"> <li>• Use the scanner glass for single-page documents, book pages, small items (such as postcards or photos), transparencies, photo paper, or thin media (such as magazine clippings).</li> <li>• Place the document facedown in the corner with the arrow.</li> </ul>

## Configuring the e-mail SMTP settings

Configure the Simple Mail Transfer Protocol (SMTP) settings to send a scanned document through e-mail. The settings vary with each e-mail service provider.

Before you begin, make sure that the printer is connected to a network and that the network is connected to the Internet.

### Using the Embedded Web Server

- 1 Open a web browser, and then type the printer IP address in the address field.

**Notes:**

- View the printer IP address on the printer home screen. The IP address appears as four sets of numbers separated by periods, such as 123.123.123.123.
- If you are using a proxy server, then temporarily disable it to load the web page correctly.

- 2 Click **Settings** > **E-mail**.

- 3 From the E-mail Setup section, configure the settings.

**Notes:**

- For more information on the password, see the list of [e-mail service providers](#).
- For e-mail service providers that are not on the list, contact your provider and ask for the settings.

- 4 Click **Save**.

## Using the Settings menu in the printer

1 From the home screen, touch **Settings** > **E-mail** > **E-mail Setup**.

2 Configure the settings.

### Notes:

- For more information on the password, see the list of [e-mail service providers](#).
- For e-mail service providers that are not on the list, contact your provider and ask for the settings.

## E-mail service providers

- [AOL Mail](#)
- [Comcast Mail](#)
- [Gmail](#)
- [iCloud Mail](#)
- [Mail.com](#)
- [NetEase Mail \(mail.126.com\)](#)
- [NetEase Mail \(mail.163.com\)](#)
- [NetEase Mail \(mail.yeah.net\)](#)
- [Outlook Live or Microsoft 365](#)
- [QQ Mail](#)
- [Sina Mail](#)
- [Sohu Mail](#)
- [Yahoo! Mail](#)
- [Zoho Mail](#)

### Notes:

- If you encounter errors using the settings provided, then contact your e-mail service provider.
- For e-mail service providers that are not on the list, contact your provider.

## AOL Mail

Setting	Value
<b>Primary SMTP Gateway</b>	smtp.aol.com
<b>Primary SMTP Gateway Port</b>	587
<b>Use SSL/TLS</b>	Required
<b>Require Trusted Certificate</b>	Disabled
<b>Reply Address</b>	Your e-mail address
<b>SMTP Server Authentication</b>	Login / Plain
<b>Device-Initiated E-mail</b>	Use Device SMTP Credentials
<b>Device UserID</b>	Your e-mail address

Setting	Value
<b>Device Password</b>	App password <b>Note:</b> To create an app password, go to the <a href="#">AOL Account Security</a> page, log in to your account, and then click <b>Generate app password</b> .

### Comcast Mail

Setting	Value
<b>Primary SMTP Gateway</b>	smtp.comcast.net
<b>Primary SMTP Gateway Port</b>	587
<b>Use SSL/TLS</b>	Required
<b>Require Trusted Certificate</b>	Disabled
<b>Reply Address</b>	Your e-mail address
<b>SMTP Server Authentication</b>	Login / Plain
<b>Device-Initiated E-mail</b>	Use Device SMTP Credentials
<b>Device UserID</b>	Your e-mail address
<b>Device Password</b>	Account password

### Gmail™

**Note:** Make sure that two-step verification is enabled on your Google account. To enable two-step verification, go to the [Google Account Security](#) page, log in to your account, and then from the “Signing in to Google” section, click **2-Step Verification**.

Setting	Value
<b>Primary SMTP Gateway</b>	smtp.gmail.com
<b>Primary SMTP Gateway Port</b>	587
<b>Use SSL/TLS</b>	Required
<b>Require Trusted Certificate</b>	Disabled
<b>Reply Address</b>	Your e-mail address
<b>SMTP Server Authentication</b>	Login / Plain
<b>Device-Initiated E-mail</b>	Use Device SMTP Credentials
<b>Device UserID</b>	Your e-mail address
<b>Device Password</b>	App password <b>Notes:</b> <ul style="list-style-type: none"> <li>To create an app password, go to the <a href="#">Google Account Security</a> page, log in to your account, and then from the “Signing in to Google” section, click <b>App passwords</b>.</li> <li>“App passwords” shows only if two-step verification is enabled.</li> </ul>

## iCloud Mail

**Note:** Make sure that two-step verification is enabled on your account.

Setting	Value
<b>Primary SMTP Gateway</b>	smtp.mail.me.com
<b>Primary SMTP Gateway Port</b>	587
<b>Use SSL/TLS</b>	Required
<b>Require Trusted Certificate</b>	Disabled
<b>Reply Address</b>	Your e-mail address
<b>SMTP Server Authentication</b>	Login / Plain
<b>Device-Initiated E-mail</b>	Use Device SMTP Credentials
<b>Device UserID</b>	Your e-mail address
<b>Device Password</b>	App password <b>Note:</b> To create an app password, go to the <a href="#">iCloud Account Management</a> page, log in to your account, and then from the Security section, click <b>Generate Password</b> .

## Mail.com

Setting	Value
<b>Primary SMTP Gateway</b>	smtp.mail.com
<b>Primary SMTP Gateway Port</b>	587
<b>Use SSL/TLS</b>	Required
<b>Require Trusted Certificate</b>	Disabled
<b>Reply Address</b>	Your e-mail address
<b>SMTP Server Authentication</b>	Login / Plain
<b>Device-Initiated E-mail</b>	Use Device SMTP Credentials
<b>Device UserID</b>	Your e-mail address
<b>Device Password</b>	Account password

## NetEase Mail (mail.126.com)

**Note:** Make sure that the SMTP service is enabled on your account. To enable the service, from the NetEase Mail home page, click **Settings > POP3/SMTP/IMAP**, and then enable either **IMAP/SMTP service** or **POP3/SMTP service**.

Setting	Value
<b>Primary SMTP Gateway</b>	smtp.126.com
<b>Primary SMTP Gateway Port</b>	465
<b>Use SSL/TLS</b>	Required
<b>Require Trusted Certificate</b>	Disabled



Setting	Value
<b>Reply Address</b>	Your e-mail address
<b>SMTP Server Authentication</b>	Login / Plain
<b>Device-Initiated E-mail</b>	Use Device SMTP Credentials
<b>Device UserID</b>	Your e-mail address
<b>Device Password</b>	Authorization password <b>Note:</b> The authorization password is provided when IMAP/SMTP service or POP3/SMTP service is enabled.

### NetEase Mail (mail.163.com)

**Note:** Make sure that the SMTP service is enabled on your account. To enable the service, from the NetEase Mail home page, click **Settings > POP3/SMTP/IMAP**, and then enable either **IMAP/SMTP service** or **POP3/SMTP service**.

Setting	Value
<b>Primary SMTP Gateway</b>	smtp.163.com
<b>Primary SMTP Gateway Port</b>	465
<b>Use SSL/TLS</b>	Required
<b>Require Trusted Certificate</b>	Disabled
<b>Reply Address</b>	Your e-mail address
<b>SMTP Server Authentication</b>	Login / Plain
<b>Device-Initiated E-mail</b>	Use Device SMTP Credentials
<b>Device UserID</b>	Your e-mail address
<b>Device Password</b>	Authorization password <b>Note:</b> The authorization password is provided when IMAP/SMTP service or POP3/SMTP service is enabled.

### NetEase Mail (mail.yeah.net)

**Note:** Make sure that the SMTP service is enabled on your account. To enable the service, from the NetEase Mail home page, click **Settings > POP3/SMTP/IMAP**, and then enable either **IMAP/SMTP service** or **POP3/SMTP service**.

Setting	Value
<b>Primary SMTP Gateway</b>	smtp.yeah.net
<b>Primary SMTP Gateway Port</b>	465
<b>Use SSL/TLS</b>	Required
<b>Require Trusted Certificate</b>	Disabled
<b>Reply Address</b>	Your e-mail address
<b>SMTP Server Authentication</b>	Login / Plain

Setting	Value
<b>Device-Initiated E-mail</b>	Use Device SMTP Credentials
<b>Device UserID</b>	Your e-mail address
<b>Device Password</b>	Authorization password <b>Note:</b> The authorization password is provided when IMAP/SMTP service or POP3/SMTP service is enabled.

## Outlook Live or Microsoft 365

These settings apply to outlook.com and hotmail.com e-mail domains, and Microsoft 365 accounts.

Setting	Value
<b>Primary SMTP Gateway</b>	smtp.office365.com
<b>Primary SMTP Gateway Port</b>	587
<b>Use SSL/TLS</b>	Required
<b>Require Trusted Certificate</b>	Disabled
<b>Reply Address</b>	Your e-mail address
<b>SMTP Server Authentication</b>	Login / Plain
<b>Device-Initiated E-mail</b>	Use Device SMTP Credentials
<b>Device UserID</b>	Your e-mail address
<b>Device Password</b>	Account password or app password <b>Notes:</b> <ul style="list-style-type: none"> <li>• For accounts with two-step verification disabled, use your account password.</li> <li>• For outlook.com or hotmail.com accounts with two-step verification enabled, use an app password. To create an app password, go to the <a href="#">Outlook Live Account Management</a> page, and then log in to your account.</li> </ul>

**Note:** For additional setup options for business using Microsoft 365, go to the [Microsoft 365 help page](#).

## QQ Mail

**Note:** Make sure that the SMTP service is enabled on your account. To enable the service, from the QQ Mail home page, click **Settings > Account**. From the POP3/IMAP/SMTP/Exchange/CardDAV/CalDAV Service section, enable either **POP3/SMTP service** or **IMAP/SMTP service**.

Setting	Value
<b>Primary SMTP Gateway</b>	smtp.qq.com
<b>Primary SMTP Gateway Port</b>	587
<b>Use SSL/TLS</b>	Required
<b>Require Trusted Certificate</b>	Disabled
<b>Reply Address</b>	Your e-mail address

Setting	Value
<b>SMTP Server Authentication</b>	Login / Plain
<b>Device-Initiated E-mail</b>	Use Device SMTP Credentials
<b>Device UserID</b>	Your e-mail address
<b>Device Password</b>	Authorization code <b>Note:</b> To generate an authorization code, from the QQ Mail home page, click <b>Settings &gt; Account</b> , and then from the POP3/IMAP/SMTP/Exchange/CardDAV/CalDAV Service section, click <b>Generate authorization code</b> .

### Sina Mail

**Note:** Make sure that the POP3/SMTP service is enabled on your account. To enable the service, from the Sina Mail home page, click **Settings > More settings > User-end POP/IMAP/SMTP**, and then enable **POP3/SMTP service**.

Setting	Value
<b>Primary SMTP Gateway</b>	smtp.sina.com
<b>Primary SMTP Gateway Port</b>	587
<b>Use SSL/TLS</b>	Required
<b>Require Trusted Certificate</b>	Disabled
<b>Reply Address</b>	Your e-mail address
<b>SMTP Server Authentication</b>	Login / Plain
<b>Device-Initiated E-mail</b>	Use Device SMTP Credentials
<b>Device UserID</b>	Your e-mail address
<b>Device Password</b>	Authorization code <b>Note:</b> To create an authorization code, from the e-mail home page, click <b>Settings &gt; More settings &gt; User-end POP/IMAP/SMTP</b> , and then enable <b>Authorization code status</b> .

### Sohu Mail

**Note:** Make sure that the SMTP service is enabled on your account. To enable the service, from the Sohu Mail home page, click **Options > Settings > POP3/SMTP/IMAP**, and then enable either **IMAP/SMTP service** or **POP3/SMTP service**.

Setting	Value
<b>Primary SMTP Gateway</b>	smtp.sohu.com
<b>Primary SMTP Gateway Port</b>	465
<b>Use SSL/TLS</b>	Required
<b>Require Trusted Certificate</b>	Disabled
<b>Reply Address</b>	Your e-mail address
<b>SMTP Server Authentication</b>	Login / Plain

Setting	Value
<b>Device-Initiated E-mail</b>	Use Device SMTP Credentials
<b>Device UserID</b>	Your e-mail address
<b>Device Password</b>	Independent password <b>Note:</b> The independent password is provided when IMAP/SMTP service or POP3/SMTP service is enabled.

### Yahoo! Mail

Setting	Value
<b>Primary SMTP Gateway</b>	smtp.mail.yahoo.com
<b>Primary SMTP Gateway Port</b>	587
<b>Use SSL/TLS</b>	Required
<b>Require Trusted Certificate</b>	Disabled
<b>Reply Address</b>	Your e-mail address
<b>SMTP Server Authentication</b>	Login / Plain
<b>Device-Initiated E-mail</b>	Use Device SMTP Credentials
<b>Device UserID</b>	Your e-mail address
<b>Device Password</b>	App password <b>Note:</b> To create an app password, go to the <a href="#">Yahoo Account Security</a> page, log in to your account, and then click <b>Generate app password</b> .

### Zoho Mail

Setting	Value
<b>Primary SMTP Gateway</b>	smtp.zoho.com
<b>Primary SMTP Gateway Port</b>	587
<b>Use SSL/TLS</b>	Required
<b>Require Trusted Certificate</b>	Disabled
<b>Reply Address</b>	Your e-mail address
<b>SMTP Server Authentication</b>	Login / Plain
<b>Device-Initiated E-mail</b>	Use Device SMTP Credentials
<b>Device UserID</b>	Your e-mail address

Setting	Value
<b>Device Password</b>	Account password or app password <b>Notes:</b> <ul style="list-style-type: none"> <li>• For accounts with two-step verification disabled, use your account password.</li> <li>• For accounts with two-step verification enabled, use an app password. To create an app password, go to the <a href="#">Zoho Mail Account Security</a> page, log in to your account, and then from the Application-Specific Passwords section, click <b>Generate New Password</b>.</li> </ul>

## Sending an e-mail

Before you begin, make sure that the SMTP settings are configured. For more information, see [“Configuring the e-mail SMTP settings” on page 57](#).

### Using the control panel

- 1 Load an original document into the ADF tray or on the scanner glass.
- 2 From the home screen, touch **E-mail**, and then enter the needed information.
- 3 If necessary, configure the output file type settings.
- 4 Send the e-mail.

### Using a shortcut number

- 1 Load an original document into the ADF tray or on the scanner glass.
- 2 From the home screen, touch **Shortcut Center > E-mail**.
- 3 Select the shortcut number.
- 4 Send the e-mail.

## Creating an e-mail shortcut

- 1 From the home screen, touch **E-mail**.
- 2 Configure the settings, and then touch .
- 3 Create a shortcut.

# Faxing

## Using the automatic document feeder and scanner glass

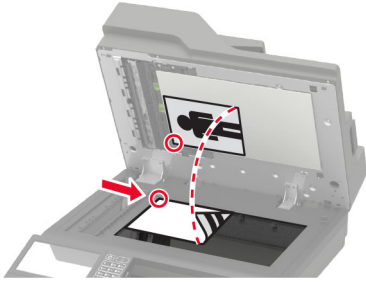
Automatic document feeder (ADF)	Scanner glass
 <ul style="list-style-type: none"> <li>• Use the ADF for multiple-page or two-sided documents.</li> <li>• Load an original document faceup. For multiple-page documents, make sure to align the leading edge before loading.</li> <li>• Make sure to adjust the ADF guides to match the width of the paper that you are loading.</li> </ul>	 <ul style="list-style-type: none"> <li>• Use the scanner glass for single-page documents, book pages, small items (such as postcards or photos), transparencies, photo paper, or thin media (such as magazine clippings).</li> <li>• Place the document facedown in the corner with the arrow.</li> </ul>

## Setting up the printer to fax

### Notes:

- The following connection methods are applicable only in some countries or regions.
- During the initial printer setup, clear the fax function check box and any other function that you plan to set up later, and then select **Continue**.
- If the fax function is enabled and not fully set up, then the indicator light may blink red.

**Warning—Potential Damage:** To avoid loss of data or printer malfunction, do not touch cables or the printer in the area shown while actively sending or receiving a fax.



## Supported fax

Printer model	Analog fax	etherFAX <sup>1</sup>	Fax server	Fax over IP (FoIP) <sup>2</sup>
MX822ade	✓	✓	✓	✓
MX822adtfe	✓	✓	✓	✓
MX822adx	✓	✓	✓	✓
MX822de	x	✓	✓	✓
MX826ade	✓	✓	✓	✓
MX826adtfe	✓	✓	✓	✓
MX826adx	✓	✓	✓	✓
MX826de	x	✓	✓	✓
XM7355	✓	✓	✓	✓
XM7335b	✓	✓	✓	✓
XM7335bi	x	✓	✓	✓
XM7335i	x	✓	✓	✓
XM7370	✓	✓	✓	✓
XM7370i	x	✓	✓	✓

<sup>1</sup> Needs a subscription. For more information, go to <https://www.etherfax.net/lexmark> or contact the place where you purchased the printer.

<sup>2</sup> Needs an installed license bundle. For more information, contact the place where you purchased the printer.

## Setting up the fax function using analog fax

### Notes:

- This feature is available only in some printer models.
- Some connection methods are applicable only in some countries or regions.
- If the fax function is enabled and not fully set up, then the indicator light may blink red.
- If you do not have a TCP/IP environment, then use the control panel to set up fax.

**Warning—Potential Damage:** To avoid loss of data or printer malfunction, do not touch cables or the printer in the area shown while actively sending or receiving a fax.



### Using the Settings menu in the printer

- 1 From the home screen, touch **Settings > Fax > Fax Setup > General Fax settings**.
- 2 Configure the settings.

### Using the Embedded Web Server

- 1 Open a web browser, and then type the printer IP address in the address field.

**Notes:**

- View the printer IP address on the home screen. The IP address appears as four sets of numbers separated by periods, such as 123.123.123.123.
- If you are using a proxy server, then temporarily disable it to load the web page correctly.

- 2 Click **Settings > Fax > Fax Setup > General Fax Settings**.
- 3 Configure the settings.
- 4 Apply the changes.

## Setting up the fax function using etherFAX

**Notes:**

- The printer firmware must be updated to the latest version. For more information, see the “Updating firmware” section.
- An appropriate license bundle must be installed in your printer. For more information, contact etherFAX.
- Make sure that you have registered your printer to the etherFAX portal. For more information, go to <https://www.etherfax.net/lexmark>.
- The printer serial number is required on registration. To locate the serial number, see [“Finding the printer serial number” on page 12](#).

- 1 Open a web browser, and then type the printer IP address in the address field.

**Notes:**

- View the printer IP address on the home screen. The IP address appears as four sets of numbers separated by periods, such as 123.123.123.123.



- If you are using a proxy server, then temporarily disable it to load the web page correctly.

**2** Click **Settings > Fax > Fax Setup > General Fax Settings**.

**Note:** Fax Setup appears only if Fax Mode is set to Fax.

**3** In the Fax Name field, type a unique name.

**4** In the Fax Number field, enter the fax number that etherFAX provided.

**5** From the Fax Transport menu, select **etherFAX**.

**Notes:**

- This menu shows up only when more than one fax transport is available.
- If the printer only has etherFAX installed, then it is automatically configured.

**6** Apply the changes.

## Setting up the fax function using fax server

**Notes:**

- This feature lets you send fax messages to a fax service provider that supports e-mail receiving.
- This feature supports outgoing fax messages only. To support fax receive, make sure that you have a device-based fax, such as analog fax, etherFAX, or Fax over IP (FoIP), configured in your printer.

**1** Open a web browser, and then type the printer IP address in the address field.

**Notes:**

- View the printer IP address on the home screen. The IP address appears as four sets of numbers separated by periods, such as 123.123.123.123.
- If you are using a proxy server, then temporarily disable it to load the web page correctly.

**2** Click **Settings > Fax**.

**3** From the Fax Mode menu, select **Fax Server**, and then click **Save**.

**4** Click **Fax Server Setup**.

**5** In the To Format field, type **[#]@myfax.com**, where **[#]** is the fax number and **myfax.com** is the fax provider domain.

**Notes:**

- If necessary, configure the Reply Address, Subject, or Message fields.
- To let the printer receive fax messages, enable the device-based fax receive setting. Make sure that you have a device-based fax configured.

**6** Click **Save**.

**7** Click **Fax Server E-mail Settings**, and then do either of the following:

- Enable **Use E-mail SMTP Server**.

**Note:** If the E-mail SMTP settings are not configured, then see [“Configuring the e-mail SMTP settings” on page 57](#).

- Configure the SMTP settings. For more information, contact your e-mail service provider.

**8** Apply the changes.

## Setting up fax using a standard telephone line

**Note:** These instructions apply only to printers that support analog fax. For more information, see [“Supported fax” on page 67](#).

**⚠ CAUTION—SHOCK HAZARD:** To avoid the risk of electrical shock, do not set up this product or make any electrical or cabling connections, such as the power cord, fax feature, or telephone, during a lightning storm.

**⚠ CAUTION—SHOCK HAZARD:** To avoid the risk of electrical shock, do not use the fax feature during a lightning storm.

**⚠ CAUTION—POTENTIAL INJURY:** To reduce the risk of fire, use only a 26 AWG or larger telecommunications (RJ-11) cord when connecting this product to the public switched telephone network. For users in Australia, the cord must be approved by the Australian Communications and Media Authority.

### Setup 1: Printer is connected to a dedicated fax line

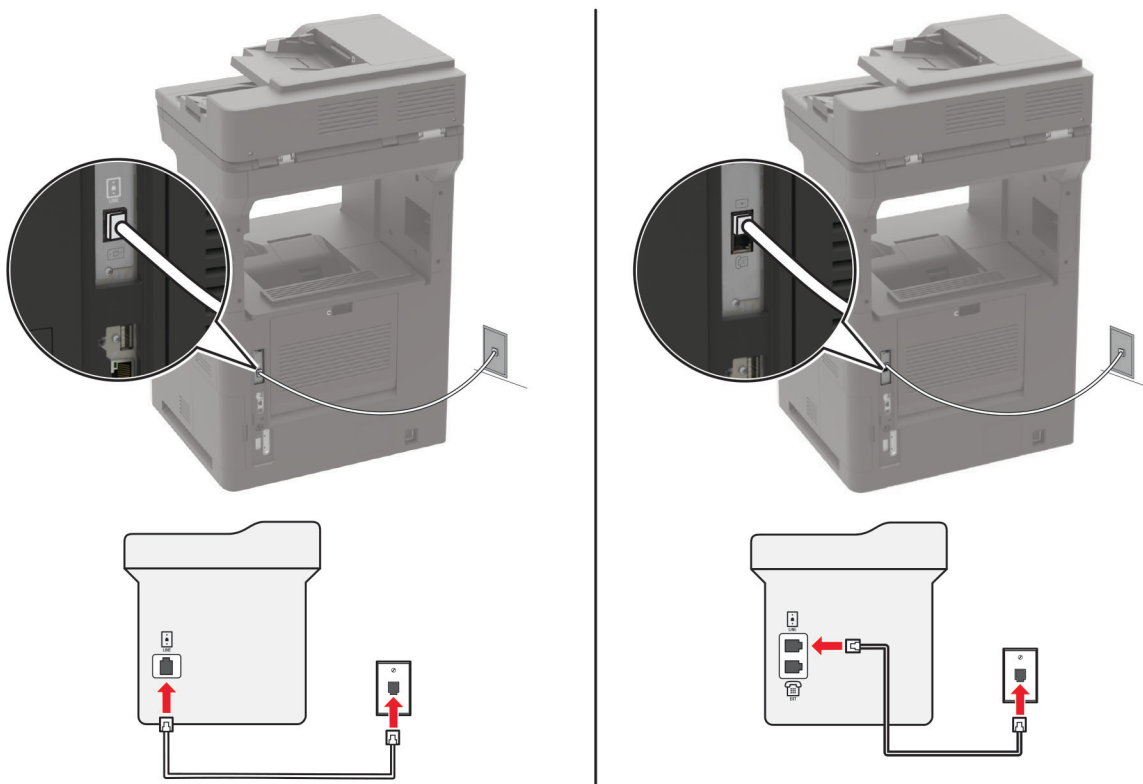

- 1 Connect one end of the telephone cable to the line port of the printer.
- 2 Connect the other end of the cable to an active analog telephone wall jack.

**Notes:**

- You can set the printer to receive faxes automatically (set Auto Answer to **On**) or manually (set Auto Answer to **Off**).
- If you want to receive faxes automatically, then set the printer to pick up on a specified number of rings.

**Setup 2: Printer is sharing the line with an answering machine**

**Note:** If you subscribe to a distinctive ring service, then make sure that you set the correct ring pattern for the printer. Otherwise, the printer does not receive faxes even if you have set it to receive faxes automatically.

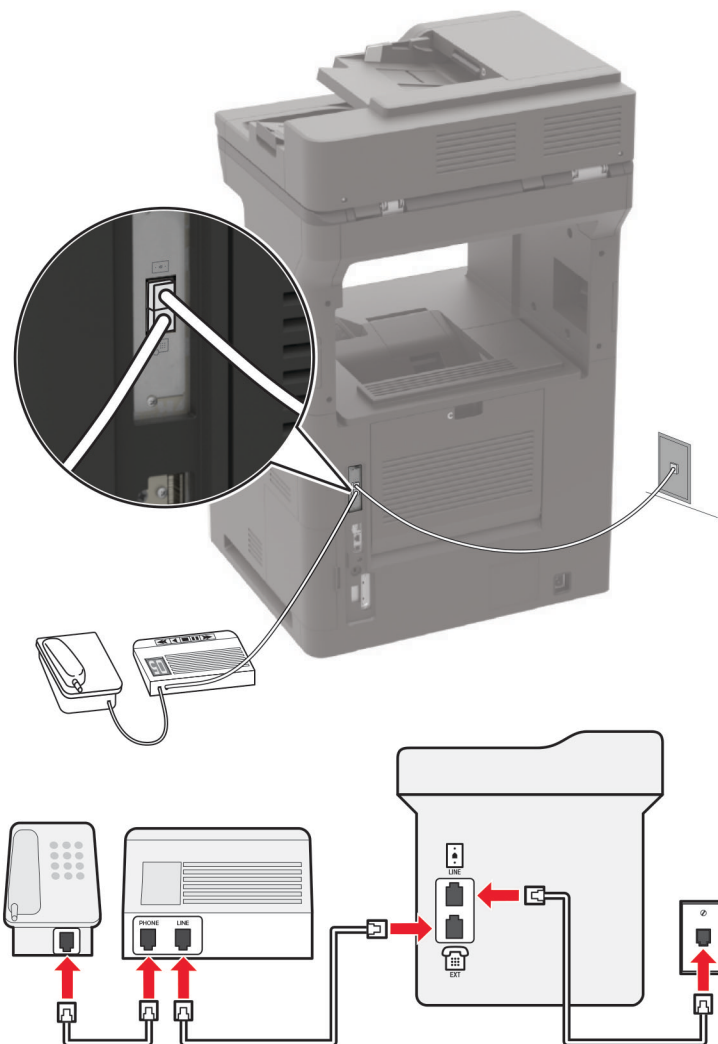
**Connected to the same telephone wall jack**

**Note:** These instructions apply only to printers that have EXT and line ports.

- Connect one end of the telephone cable to the line port of the printer.
- Connect the other end of the cable to an active analog wall jack.
- Connect the answering machine to the telephone port of the printer.

### Connected to different wall jacks

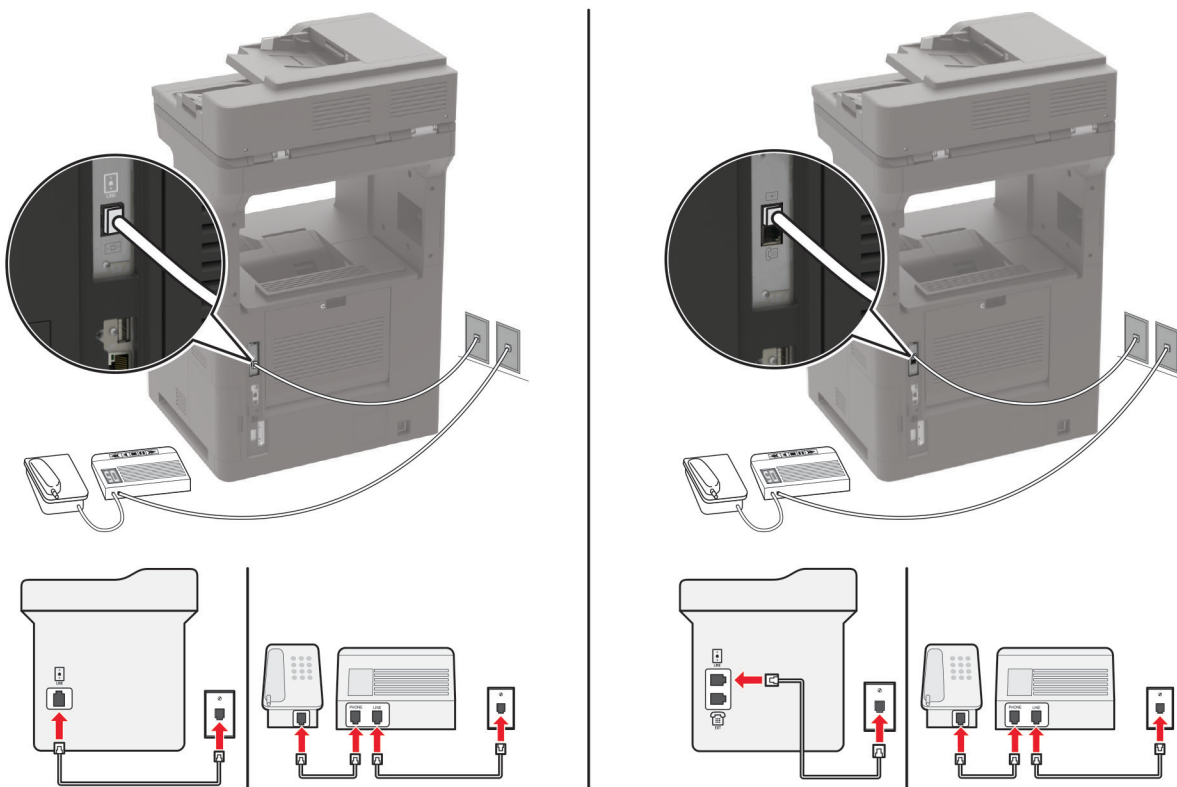

- 1 Connect one end of the telephone cable to the line port of the printer.
- 2 Connect the other end of the cable to an active analog wall jack.

### Notes:

- If you have only one telephone number on your line, then set the printer to receive faxes automatically.
- Set the printer to pick up calls two rings after the answering machine. For example, if the answering machine picks up calls after four rings, then set the printer Rings to Answer setting to **6**.

## Setting up fax in countries or regions with different telephone wall jacks and plugs

**Note:** These instructions apply only to printers that support analog fax. For more information, see [“Supported fax” on page 67](#).

**⚡ CAUTION—SHOCK HAZARD:** To avoid the risk of electrical shock, do not set up this product or make any electrical or cabling connections, such as the power cord, fax feature, or telephone, during a lightning storm.

**⚠ CAUTION—SHOCK HAZARD:** To avoid the risk of electrical shock, do not use the fax feature during a lightning storm.

**⚠ CAUTION—POTENTIAL INJURY:** To reduce the risk of fire, use only a 26 AWG or larger telecommunications (RJ-11) cord when connecting this product to the public switched telephone network. For users in Australia, the cord must be approved by the Australian Communications and Media Authority.

The standard wall jack adopted by most countries or regions is RJ-11. If the wall jack or equipment in your facility is not compatible with this type of connection, then use a telephone adapter. An adapter for your country or region may not come with your printer, and you may need to purchase it separately.

There may be an adapter plug installed in the telephone port of the printer. Do not remove the adapter plug from the telephone port of the printer if you are connecting to a serial or cascaded telephone system.

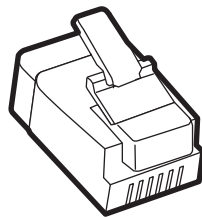

Part name	Part number
Lexmark adapter plug	40X8519

### Connecting the printer to a non-RJ-11 wall jack

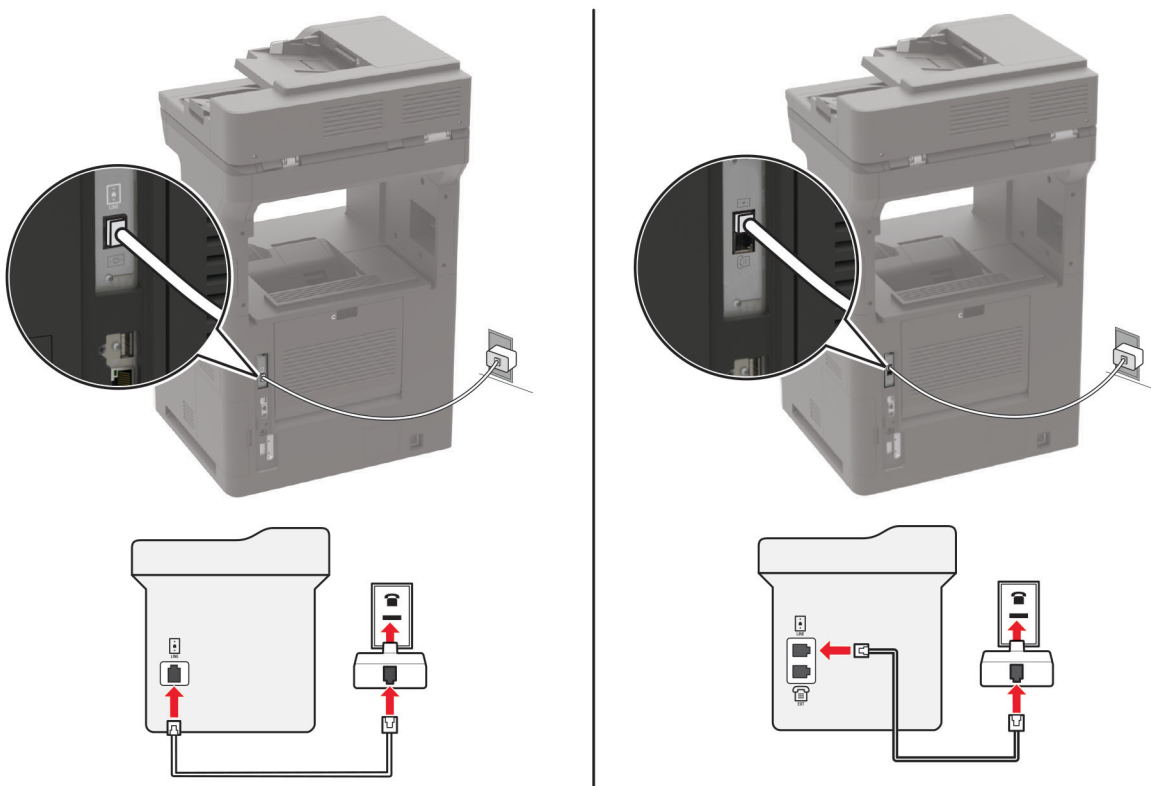

- 1 Connect one end of the telephone cable to the line port of the printer.
- 2 Connect the other end of the cable to the RJ-11 adapter, and then connect the adapter to the wall jack.
- 3 If you want to connect another device with a non-RJ-11 connector to the same wall jack, then connect it directly to the telephone adapter.

## Connecting to a distinctive ring service

A distinctive ring service lets you have multiple telephone numbers on one telephone line. Each telephone number is assigned a different ring pattern.

**Note:** These instructions apply only to printers that support analog fax. For more information, see [“Supported fax” on page 67](#).

- 1 From the home screen, touch **Settings > Fax > Fax Setup > Fax Receive Settings > Admin Controls > Answer On**.
- 2 Select a ring pattern.

## Setting the fax date and time

**Note:** Make sure that fax is configured. For more information, see [“Setting up the printer to fax” on page 66](#).

- 1 From the home screen, touch **Settings > Device > Preferences > Date and Time > Configure**.
- 2 Configure the settings.

## Configuring daylight saving time

**Note:** Make sure that fax is configured. For more information, see [“Setting up the printer to fax” on page 66](#).

- 1 From the home screen, touch **Settings > Device > Preferences > Date and Time > Configure**.
- 2 In the Time Zone menu, select **(UTC+user) Custom**.
- 3 Configure the settings.

## Sending a fax

**Note:** Make sure that fax is configured. For more information, see [“Setting up the printer to fax” on page 66](#).

## Using the control panel

- 1 Load an original document into the ADF tray or on the scanner glass.
- 2 From the home screen, touch **Fax**, and then enter the needed information.  
If necessary, adjust the settings.
- 3 Send the fax.

## Using the computer

Before you begin, make sure that the fax driver is installed. For more information, see [“Installing the fax driver” on page 319](#).

### For Windows users

- 1 From the document that you are trying to fax, open the Print dialog.
- 2 Select the printer, and then click **Properties, Preferences, Options, or Setup**.
- 3 Click **Fax > Enable fax > Always display settings prior to faxing**, and then enter the recipient number.  
If necessary, configure other fax settings.
- 4 Send the fax.

### For Macintosh users

- 1 With a document open, choose **File > Print**.
- 2 Select the printer that has - **Fax** added after its name.
- 3 In the To field, enter the recipient number.  
If necessary, configure other fax settings.
- 4 Send the fax.

## Scheduling a fax

**Note:** Make sure that fax is configured. For more information, see [“Setting up the printer to fax” on page 66](#).

- 1 Load an original document into the ADF tray or on the scanner glass.
- 2 From the home screen, touch **Fax > To > enter the fax number > Done**.
- 3 Touch **Send Time**, configure the date and time, and then touch **OK**.
- 4 Send the fax.

## Creating a fax destination shortcut

**Note:** Make sure that fax is configured. For more information, see [“Setting up the printer to fax” on page 66](#).

- 1 From the home screen, touch **Fax > To**.
- 2 Enter the recipient number, and then touch **Done**.
- 3 Touch .
- 4 Create a shortcut.

## Changing the fax resolution

**Note:** Make sure that fax is configured. For more information, see [“Setting up the printer to fax” on page 66](#).

- 1 Load an original document into the ADF tray or on the scanner glass.
- 2 From the home screen, touch **Fax**, and then enter the needed information.
- 3 Touch **Resolution**, and then adjust the setting.
- 4 Send the fax.

## Adjusting the fax darkness

**Note:** Make sure that fax is configured. For more information, see [“Setting up the printer to fax” on page 66](#).

- 1 Load an original document into the ADF tray or on the scanner glass.
- 2 From the home screen, touch **Fax**, and then enter the needed information.
- 3 Touch **Darkness**, and then adjust the setting.
- 4 Send the fax.

## Printing a fax log

**Note:** Make sure that fax is configured. For more information, see [“Setting up the printer to fax” on page 66](#).

- 1 From the home screen, touch **Settings** > **Reports** > **Fax**.
- 2 Touch **Fax Job Log** or **Fax Call Log**.

## Blocking junk faxes

**Note:** Make sure that fax is configured. For more information, see [“Setting up the printer to fax” on page 66](#).

- 1 From the home screen, touch **Settings** > **Fax** > **Fax Setup** > **Fax Receive Settings** > **Admin Controls**.
- 2 Set Block No Name Fax to **On**.

## Holding faxes

**Note:** Make sure that fax is configured. For more information, see [“Setting up the printer to fax” on page 66](#).

- 1 From the home screen, touch **Settings** > **Fax** > **Fax Setup** > **Fax Receive Settings** > **Holding Faxes**.
- 2 Select a mode.



## Forwarding a fax

**Note:** Make sure that fax is configured. For more information, see [“Setting up the printer to fax” on page 66](#).

**1** Create a destination shortcut.

**a** From the home screen, touch **Shortcut Center**.

**Note:** The icon and name may have been changed. For more information, contact your administrator.

**b** Select a printer function, and then touch **Create Shortcut**.

**c** Configure the settings, and then touch **Save**.

**d** Type a unique shortcut name.

**e** Touch **OK**.

**Note:** Take note of the shortcut number.

**2** From the home screen, touch **Settings > Fax > Fax Setup > Fax Receive Settings > Admin Controls**.

**3** Touch **Fax Forwarding** and then touch **Forward** or **Print and Forward**.

**4** Touch **Forward to**, and then select a destination.

**5** Select a destination type, and then enter the shortcut number of the destination.

# Scanning

## Using the automatic document feeder and scanner glass

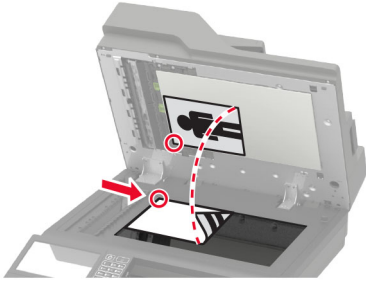
Automatic document feeder (ADF)	Scanner glass
 <ul style="list-style-type: none"> <li>• Use the ADF for multiple-page or two-sided documents.</li> <li>• Load an original document faceup. For multiple-page documents, make sure to align the leading edge before loading.</li> <li>• Make sure to adjust the ADF guides to match the width of the paper that you are loading.</li> </ul>	 <ul style="list-style-type: none"> <li>• Use the scanner glass for single-page documents, book pages, small items (such as postcards or photos), transparencies, photo paper, or thin media (such as magazine clippings).</li> <li>• Place the document facedown in the corner with the arrow.</li> </ul>

Scanning to a computer

## Scanning to a computer

Before you begin, make sure that:

- The printer firmware is updated. For more information, see the “Updating firmware” section.
- The computer and the printer are connected to the same network.

### For Windows users

#### Using Lexmark ScanBack Utility

**1** From the computer, run Lexmark ScanBack Utility, and then click **Next**.

**Note:** To download the utility, go to [www.lexmark.com/downloads](http://www.lexmark.com/downloads).

**2** Click **Setup**, and then add the printer IP address.

**Note:** View the printer IP address on the printer home screen. The IP address appears as four sets of numbers separated by periods, such as 123.123.123.123.

**3** Click **Close > Next**.

**4** Select the size of the original document, and then click **Next**.

**5** Select a file format and scan resolution, and then click **Next**.

**6** Type a unique scan profile name, and then click **Next**.

- 7 Browse to the location that you want to save the scanned document, create a file name, and then click **Next**.

**Note:** To reuse the scan profile, enable **Create Shortcut**, and then create a unique shortcut name.

- 8 Click **Finish**.
- 9 Load an original document into the automatic document feeder or on the scanner glass.
- 10 From the printer control panel, select **Scan Profiles**, and then select a scan profile.

**Note:** Make sure that Scan Profiles is enabled. From the control panel, navigate to **Settings > Device > Visible Home Screen Icons > Scan Profiles > Display**.

### Using Windows Fax and Scan

**Note:** Make sure that the printer is added to the computer. For more information, see [“Adding printers to a computer” on page 319](#).

- 1 Load an original document into the automatic document feeder or on the scanner glass.
- 2 From the computer, open **Windows Fax and Scan**.
- 3 From the Source menu, select a scanner source.
- 4 If necessary, change the scan settings.
- 5 Scan the document.

### For Macintosh users

**Note:** Make sure that the printer is added to the computer. For more information, see [“Adding printers to a computer” on page 319](#).

- 1 Load an original document into the automatic document feeder or on the scanner glass.
- 2 From the computer, do either of the following:
  - Open **Image Capture**.
  - Open **Printers & Scanners**, and then select a printer. Click **Scan > Open Scanner**.
- 3 From the Scanner window, do one or more of the following:
  - Select where you want to save the scanned document.
  - Select the size of the original document.
  - To scan from the ADF, select **Document Feeder** from the Scan Menu or enable Use Document Feeder.
  - If necessary, configure the scan settings.
- 4 Click **Scan**.

## Scanning to an FTP server

- 1 Load the original document into the ADF tray or on the scanner glass.
- 2 From the home screen, touch **FTP**, and then enter the needed information.
- 3 If necessary, configure other FTP settings.
- 4 Send the FTP job.

## Scanning to a network folder

- 1 Load the document into the ADF tray or on the scanner glass.
- 2 From the home screen, touch **Scan Center**.  
**Note:** The icon and name may have been changed. For more information, contact your administrator.
- 3 Do either of the following:
  - Select a destination.  
**Note:** For SFTP, set the port number to **22**.
  - Use a shortcut by touching ★, and then selecting the shortcut from the list.
- 4 Scan the document.

## Creating an FTP shortcut

- 1 From the home screen, touch **FTP**.
- 2 Enter the FTP server address, and then touch ★.
- 3 Create a shortcut.

## Scanning to a flash drive

- 1 Load an original document into the ADF tray or on the scanner glass.
- 2 Insert the flash drive.



- 3 Touch **Scan to USB** and adjust the settings if necessary.

**Notes:**

- To save the scanned document to a folder, touch **Scan to**, select a folder, and then touch **Scan Here**.
- If the USB Drive screen does not appear, then touch **USB Drive** on the control panel.

#### 4 Scan the document.

**Warning—Potential Damage:** To avoid loss of data or printer malfunction, do not touch the flash drive or the printer in the area shown while actively printing, reading, or writing from the memory device.



## Scanning to a Cloud Connector profile

- 1 Load an original document into the ADF tray or on the scanner glass.
- 2 From the home screen, touch **Cloud Connector**.
- 3 Select a cloud service provider, and then select a profile.

**Note:** For more information on creating a Cloud Connector profile, see [“Creating a Cloud Connector profile” on page 24](#).

- 4 Touch **Scan**, and then assign a filename and destination folder.
- 5 Touch **Scan Here**.  
If necessary, change the scan settings.
- 6 Scan the document.

# Understanding the printer menus

## Menu map

Device	<ul style="list-style-type: none"> <li>• <a href="#">Preferences</a></li> <li>• <a href="#">Eco-Mode</a></li> <li>• <a href="#">Remote Operator Panel</a></li> <li>• <a href="#">Notifications</a></li> <li>• <a href="#">Power Management</a></li> <li>• <a href="#">Anonymous Data Collection</a></li> </ul>	<ul style="list-style-type: none"> <li>• <a href="#">Accessibility</a></li> <li>• <a href="#">Restore Factory Defaults</a></li> <li>• <a href="#">Maintenance</a></li> <li>• <a href="#">Visible Home Screen Icons</a></li> <li>• <a href="#">About this Printer</a></li> </ul>
Print	<ul style="list-style-type: none"> <li>• <a href="#">Layout</a></li> <li>• <a href="#">Finishing</a></li> <li>• <a href="#">Setup</a></li> <li>• <a href="#">Quality</a></li> <li>• <a href="#">Job Accounting</a></li> <li>• <a href="#">XPS</a></li> </ul>	<ul style="list-style-type: none"> <li>• <a href="#">PDF</a></li> <li>• <a href="#">PostScript</a></li> <li>• <a href="#">PCL</a></li> <li>• <a href="#">HTML</a></li> <li>• <a href="#">Image</a></li> </ul>
Paper	<ul style="list-style-type: none"> <li>• <a href="#">Tray Configuration</a></li> <li>• <a href="#">Media Configuration</a></li> </ul>	<ul style="list-style-type: none"> <li>• <a href="#">Bin Configuration</a></li> </ul>
Copy	<a href="#">Copy Defaults</a>	
Fax	<a href="#">Fax Defaults</a>	
E-mail	<ul style="list-style-type: none"> <li>• <a href="#">E-mail Setup</a></li> <li>• <a href="#">E-mail Defaults</a></li> </ul>	<ul style="list-style-type: none"> <li>• <a href="#">Web Link Setup</a></li> </ul>
FTP	<a href="#">FTP Defaults</a>	
USB Drive	<ul style="list-style-type: none"> <li>• <a href="#">Flash Drive Scan</a></li> </ul>	<ul style="list-style-type: none"> <li>• <a href="#">Flash Drive Print</a></li> </ul>
Network/Ports	<ul style="list-style-type: none"> <li>• <a href="#">Network Overview</a></li> <li>• <a href="#">Wireless</a></li> <li>• <a href="#">Wi-Fi Direct</a></li> <li>• <a href="#">Ethernet</a></li> <li>• <a href="#">TCP/IP</a></li> <li>• <a href="#">SNMP</a></li> <li>• <a href="#">IPSec</a></li> </ul>	<ul style="list-style-type: none"> <li>• <a href="#">802.1x</a></li> <li>• <a href="#">LPD Configuration</a></li> <li>• <a href="#">HTTP/FTP Settings</a></li> <li>• <a href="#">ThinPrint</a></li> <li>• <a href="#">USB</a></li> <li>• <a href="#">Restrict external network access</a></li> </ul>
Security	<ul style="list-style-type: none"> <li>• <a href="#">Login Methods</a></li> <li>• <a href="#">Schedule USB Devices</a></li> <li>• <a href="#">Security Audit Log</a></li> <li>• <a href="#">Login Restrictions</a></li> <li>• <a href="#">Confidential Print Setup</a></li> </ul>	<ul style="list-style-type: none"> <li>• <a href="#">Disk Encryption</a></li> <li>• <a href="#">Erase Temporary Data Files</a></li> <li>• <a href="#">Solutions LDAP Settings</a></li> <li>• <a href="#">Miscellaneous</a></li> </ul>
Reports	<ul style="list-style-type: none"> <li>• <a href="#">Menu Settings Page</a></li> <li>• <a href="#">Device</a></li> <li>• <a href="#">Print</a></li> </ul>	<ul style="list-style-type: none"> <li>• <a href="#">Shortcuts</a></li> <li>• <a href="#">Fax</a></li> <li>• <a href="#">Network</a></li> </ul>

<a href="#">Help</a>	<ul style="list-style-type: none"> <li>• Print All Guides</li> <li>• Mono Quality Guide</li> <li>• Connection Guide</li> <li>• Copy Guide</li> <li>• E-mail Guide</li> <li>• Fax Guide</li> </ul>	<ul style="list-style-type: none"> <li>• FTP Guide</li> <li>• Information Guide</li> <li>• Media Guide</li> <li>• Moving Guide</li> <li>• Print Quality Guide</li> <li>• Supplies Guide</li> </ul>
<a href="#">Troubleshooting</a>	Print Quality Test Pages	Cleaning the scanner

## Device

### Preferences

Menu item	Description
<b>Display Language</b>	Set the language of the text that appears on the display.
<b>Country/Region</b>	Identify the country or region that the printer is configured to operate.
<b>Run initial setup</b> Off* On	Run the setup wizard.
<b>Keyboard</b> Keyboard Type	Select a language as a keyboard type. <b>Note:</b> All the Keyboard Type values may not appear or may require special hardware be installed to appear.
<b>Displayed information</b> Display Text 1 (IP Address*) Display Text 2 (Date/Time*) Custom Text 1 Custom Text 2	Specify the information to appear on the home screen.
<b>Date and Time</b> Configure Current Date and Time Manually Set Date and Time Date Format (MM-DD-YYYY*) Time Format (12 hour A.M./P.M.*) Time Zone (UTC-5:00*) Network Time Protocol Enable NTP (On*) NTP Server Enable Authentication	Configure the printer date and time and network time protocol.
<b>Paper Sizes</b> U.S.* Metric	Specify the unit of measurement for paper sizes. <b>Note:</b> The country or region selected in the initial setup wizard determines the initial paper size setting.
<b>Note:</b> An asterisk (*) next to a value indicates the factory default setting.	

Menu item	Description
<b>Screen Brightness</b> 20–100% (100*)	Adjust the brightness of the display.
<b>Flash Drive Access</b> Enabled* Disabled	Enable access to the flash drive.
<b>Allow Background Removal</b> Off On*	Specify whether background removal is allowed.
<b>Allow Custom Job scans</b> Off On*	Specify whether the Custom Job Scanning setting appears for copy, scan, and fax. <b>Note:</b> This menu item appears only when a hard disk is installed.
<b>One Page Flatbed Scanning</b> Off* On	Set the printer to scan any type of job involving the scanner glass as a single page. <b>Note:</b> The printer returns to the home screen after performing a single flatbed scan instead of displaying prompts.
<b>Output Lighting</b> Off On*	Enable the integrated output light or indicator light of an optional output bin.
<b>Audio Feedback</b> Button Feedback (On*) Volume (5*)	<ul style="list-style-type: none"> <li>• Enable audio feedback for button presses, panel interactions, paper loaded prompts, and error notifications.</li> <li>• Adjust the feedback volume.</li> </ul>
<b>Screen Timeout</b> 5–300 seconds (60*)	Set the idle time before the display shows the home screen or before the printer logs out a user account automatically.
<b>Note:</b> An asterisk (*) next to a value indicates the factory default setting.	

## Eco-Mode

Menu item	Description
<b>Print</b> Sides 1-Sided* 2-Sided	Specify whether to print on one side or two sides of the paper.
<b>Note:</b> An asterisk (*) next to a value indicates the factory default setting.	



Menu item	Description
<p><b>Print</b></p> <p>Pages per Side</p> <ul style="list-style-type: none"> <li>Off*</li> <li>2 pages per side</li> <li>3 pages per side</li> <li>4 pages per side</li> <li>6 pages per side</li> <li>9 pages per side</li> <li>12 pages per side</li> <li>16 pages per side</li> </ul>	<p>Print multiple page images on one side of a sheet of paper.</p>
<p><b>Print</b></p> <p>Toner Darkness</p> <ul style="list-style-type: none"> <li>1–10 (8*)</li> </ul>	<p>Determine the lightness or darkness of text images.</p>
<p><b>Copy</b></p> <p>Sides</p> <ul style="list-style-type: none"> <li>1 sided to 1 sided*</li> <li>1 sided to 2 sided</li> <li>2 sided to 1 sided</li> <li>2 sided to 2 sided</li> </ul>	<p>Specify the scanning behavior based on the original document.</p>
<p><b>Copy</b></p> <p>Pages per Side</p> <ul style="list-style-type: none"> <li>Off*</li> <li>2 Portrait pages</li> <li>4 Portrait pages</li> <li>2 Landscape pages</li> <li>4 Landscape pages</li> </ul>	<p>Specify the scanning behavior based on the original document.</p>
<p><b>Copy</b></p> <p>Darkness</p> <ul style="list-style-type: none"> <li>1–9 (5*)</li> </ul>	<p>Determine the darkness of the scanned text images.</p>
<p><b>Note:</b> An asterisk (*) next to a value indicates the factory default setting.</p>	

## Remote Operator Panel

Menu item	Description
<p><b>External VNC Connection</b></p> <ul style="list-style-type: none"> <li>Don't Allow*</li> <li>Allow</li> </ul>	<p>Connect an external Virtual Network Computing (VNC) client to the remote control panel.</p>
<p><b>Authentication Type</b></p> <ul style="list-style-type: none"> <li>None*</li> <li>Standard Authentication</li> </ul>	<p>Set the authentication type when accessing the VNC client server.</p>
<p><b>Note:</b> An asterisk (*) next to a value indicates the factory default setting.</p>	

Menu item	Description
<b>VNC Password</b>	Specify the password to connect to the VNC client server. <b>Note:</b> This menu item appears only if Authentication Type is set to Standard Authentication.
<b>Note:</b> An asterisk (*) next to a value indicates the factory default setting.	

## Notifications

Menu item	Description
<b>Error Lighting</b> Off On*	Set the indicator light to come on when a printer error occurs.
<b>ADF Loaded Beep</b> Off On*	Enable a sound when loading paper into the ADF.
<b>Alarm Control</b> Off Single* Continuous	Set the number of times that the alarm sounds when the printer requires user intervention.
<b>Supplies</b> Show Supply Estimates Show estimates* Do not show estimates	Show the estimated status of the supplies.
<b>Supplies</b> Cartridge Alarm (Off*) Staple Alarm (Off*) Hole Punch Alarm (Off*)	Set the number of times that the alarm sounds when the toner cartridge is low, the staple cartridge is empty, or the hole punch receptacle is full or missing. <b>Note:</b> Staple Alarm and Hole Punch Alarm appear only when output options are installed.
<b>Note:</b> An asterisk (*) next to a value indicates the factory default setting.	

Menu item	Description
<p><b>E-mail Alerts Setup</b></p> <ul style="list-style-type: none"> <li>E-mail Setup                             <ul style="list-style-type: none"> <li>Primary SMTP Gateway</li> <li>Primary SMTP Gateway Port (25*)</li> <li>Secondary SMTP Gateway</li> <li>Secondary SMTP Gateway Port (25*)</li> <li>SMTP Timeout (30 seconds*)</li> <li>Reply Address</li> <li>Always use SMTP default Reply Address(Off*)</li> <li>Use SSL/TLS(Disabled*)</li> <li>Require Trusted Certificate(On*)</li> <li>SMTP Server Authentication(No authentication required*)</li> <li>Device-Initiated E-mail(None*)</li> <li>User-Initiated E-mail(None*)</li> <li>Use Active Directory Device Credentials(Off*)</li> <li>Device Userid</li> <li>Device Password</li> <li>Kerberos 5 REALM</li> <li>NTLM Domain</li> <li>Disable "SMTP server not set up" (Off*)</li> </ul> </li> </ul>	<p>Configure the e-mail settings of the printer.</p>
<p><b>E-mail Alerts Setup</b></p> <ul style="list-style-type: none"> <li>Setup E-mail Lists and Alerts                             <ul style="list-style-type: none"> <li>E-mail List 1</li> <li>E-mail List 2</li> <li>E-mail Events</li> </ul> </li> </ul>	<p>Specify the e-mail addresses and enable the e-mail alert events.</p> <p><b>Note:</b> This menu item appears only in the Embedded Web Server.</p>
<p><b>Error Prevention</b></p> <ul style="list-style-type: none"> <li>ADF Multifeed Sensor                             <ul style="list-style-type: none"> <li>Off</li> <li>On*</li> </ul> </li> </ul>	<p>Detect when the ADF picks more than one sheet of media at once.</p>
<p><b>Error Prevention</b></p> <ul style="list-style-type: none"> <li>Jam Assist                             <ul style="list-style-type: none"> <li>Off</li> <li>On*</li> </ul> </li> </ul>	<p>Set the printer to flush blank pages or pages with partial prints automatically after a jammed page has been cleared.</p>
<p><b>Error Prevention</b></p> <ul style="list-style-type: none"> <li>Auto Continue                             <ul style="list-style-type: none"> <li>Off</li> <li>On* (5 seconds)</li> </ul> </li> </ul>	<p>Let the printer continue processing or printing a job automatically after clearing certain printer conditions that require user intervention.</p>

**Note:** An asterisk (\*) next to a value indicates the factory default setting.

Menu item	Description
<p><b>Error Prevention</b></p> <ul style="list-style-type: none"> <li>Auto Reboot                             <ul style="list-style-type: none"> <li>Auto Reboot                                     <ul style="list-style-type: none"> <li>Reboot when idle</li> <li>Reboot always*</li> <li>Reboot never</li> </ul> </li> </ul> </li> </ul>	<p>Set the printer to restart when an error occurs.</p>
<p><b>Error Prevention</b></p> <ul style="list-style-type: none"> <li>Auto Reboot                             <ul style="list-style-type: none"> <li>Max Auto Reboots                                     <ul style="list-style-type: none"> <li>1–20 (2*)</li> </ul> </li> </ul> </li> </ul>	<p>Set the number of automatic reboots that the printer can perform.</p>
<p><b>Error Prevention</b></p> <ul style="list-style-type: none"> <li>Auto Reboot                             <ul style="list-style-type: none"> <li>Auto Reboot Window                                     <ul style="list-style-type: none"> <li>1–525600 seconds (720*)</li> </ul> </li> </ul> </li> </ul>	<p>Set the time before the printer performs an automatic reboot.</p>
<p><b>Error Prevention</b></p> <ul style="list-style-type: none"> <li>Auto Reboot                             <ul style="list-style-type: none"> <li>Auto Reboot Counter</li> </ul> </li> </ul>	<p>Show a read-only information of the reboot counter.</p>
<p><b>Error Prevention</b></p> <ul style="list-style-type: none"> <li>Auto Reboot                             <ul style="list-style-type: none"> <li>Reset Auto Reboot Counter                                     <ul style="list-style-type: none"> <li>Cancel</li> <li>Continue</li> </ul> </li> </ul> </li> </ul>	<p>Reset Auto Reboot Counter.</p>
<p><b>Error Prevention</b></p> <ul style="list-style-type: none"> <li>Display Short Paper Error                             <ul style="list-style-type: none"> <li>On</li> <li>Auto-clear*</li> </ul> </li> </ul>	<p>Set the printer to show a message when a short paper error occurs.</p> <p><b>Note:</b> Short paper refers to the size of the paper loaded.</p>
<p><b>Error Prevention</b></p> <ul style="list-style-type: none"> <li>Page Protect                             <ul style="list-style-type: none"> <li>Off*</li> <li>On</li> </ul> </li> </ul>	<p>Set the printer to process the entire page into the memory before printing it.</p>
<p><b>Jam Content Recovery</b></p> <ul style="list-style-type: none"> <li>Jam Recovery                             <ul style="list-style-type: none"> <li>Off</li> <li>On</li> <li>Auto*</li> </ul> </li> </ul>	<p>Set the printer to reprint jammed pages.</p>
<p><b>Jam Content Recovery</b></p> <ul style="list-style-type: none"> <li>Scanner Jam Recovery                             <ul style="list-style-type: none"> <li>Job level</li> <li>Page level*</li> </ul> </li> </ul>	<p>Specify how to restart a scan job after resolving a paper jam.</p>
<p><b>Note:</b> An asterisk (*) next to a value indicates the factory default setting.</p>	

## Power Management

Menu item	Description
<b>Sleep Mode Profile</b> Print from Sleep Mode Stay awake after printing Enter Sleep Mode after printing*	Set the printer to stay in Ready mode or return to Sleep mode after printing.
<b>Timeouts</b> Sleep Mode 1–120 minutes (15*)	Set the idle time before the printer begins operating in Sleep mode.
<b>Timeouts</b> Hibernate Timeout Disabled 1 hour 2 hours 3 hours 6 hours 1 day 2 days 3 days* 1 week 2 weeks 1 month	Set the time before the printer turns off.
<b>Timeouts</b> Hibernate Timeout on Connection Hibernate Do Not Hibernate*	Set Hibernate Timeout to turn off the printer while an active Ethernet connection exists.
<b>Schedule Power Modes</b> Schedules Add New Schedule	Schedule the printer when to enter Sleep or Hibernate mode.
<b>Note:</b> An asterisk (*) next to a value indicates the factory default setting.	

## Anonymous Data Collection

Menu item	Description
<b>Anonymous Data Collection</b> Device Usage and Performance Information None*	Send printer usage and performance information to Lexmark.  <b>Note:</b> Anonymous Data Send Time appears only when you set Anonymous Data Collection to Device Usage and Performance.
<b>Anonymous Data Send Time</b> Start Time Stop Time	
<b>Note:</b> An asterisk (*) next to a value indicates the factory default setting.	

## Accessibility

Menu item	Description
<b>Duplicate Key Strike Interval</b> 0–5 (0*)	Set the interval in seconds during which the printer ignores duplicate key presses on an attached keyboard.
<b>Key Repeat Initial Delay</b> 0.25–5 (1*)	Set the initial length of delay in seconds before a repeating key starts repeating. <b>Note:</b> This menu item appears only when a keyboard is attached to the printer.
<b>Key Repeat Rate</b> 0.5–30 (30*)	Set the number of presses per second for a repeating key. <b>Note:</b> This menu item appears only when a keyboard is attached to the printer.
<b>Prolong Screen Timeout</b> Off* On	Let the user remain in the same location and reset the Screen Timeout timer when it expires instead of returning to the home screen.
<b>Headphone Volume</b> 1–10 (5*)	Adjust the headphone volume. <b>Note:</b> This menu item appears only when a headphone is attached to the printer.
<b>Enable Voice Guidance When Headphone Is Attached</b> Off* On	Enable Voice Guidance when a headphone is attached to the printer.
<b>Speak Passwords/PINs</b> Off* On	Set the printer to read out loud passwords or personal identification numbers. <b>Note:</b> This menu item appears only when a headphone or a speaker is attached to the printer.
<b>Speech Rate</b> Very Slow Slow Normal* Fast Faster Very Fast Rapid Very Rapid Fastest	Set the Voice Guidance speech rate. <b>Note:</b> This menu item appears only when a headphone or a speaker is attached to the printer.

**Note:** An asterisk (\*) next to a value indicates the factory default setting.

## Restore Factory Defaults

Menu item	Description
<b>Restore Settings</b> Restore all settings Restore printer settings Restore network settings Restore fax settings Restore app settings	Restore the printer factory default settings.

## Maintenance

### Configuration Menu

Menu item	Description
<b>USB Configuration</b> USB PnP 1* 2	Change the USB driver mode of the printer to improve its compatibility with a personal computer.
<b>USB Configuration</b> USB Scan to Local Off On*	Set whether the USB device driver enumerates as a USB Simple device (single interface) or as a USB Composite device (multiple interfaces).
<b>USB Configuration</b> USB Speed Full Auto*	Set the USB port to run at full speed and disable its high-speed capabilities.
<b>Tray Configuration</b> Size Sensing Tray [x] Sensing Off On*	Set the tray to sense automatically the paper size loaded into it.
<b>Tray Configuration</b> Tray Linking Automatic* Off	Set the printer to link the trays that have the same paper type and paper size settings.
<b>Tray Configuration</b> Show Tray Insert Message Off Only for unknown sizes* Always	Display a message to select paper size and type after inserting the tray.

**Note:** An asterisk (\*) next to a value indicates the factory default setting.

Menu item	Description
<b>Tray Configuration</b> A5 Loading Short Edge Long Edge*	Determine the default loading orientation for the A5 size paper in all paper sources.
<b>Tray Configuration</b> Paper Prompts Auto* Multipurpose Feeder Manual Paper	Set the paper source that the user fills when a prompt to load paper appears.
<b>Tray Configuration</b> Envelope Prompts Auto* Multipurpose Feeder Manual Envelope	Set the paper source that the user fills when a prompt to load envelope appears.
<b>Tray Configuration</b> Action for Prompts Prompt user* Continue Use current	Set the printer to resolve paper- or envelope-related change prompts.
<b>Reports</b> Menu Settings Page Event Log Event Log Summary HealthCheck Statistics	Print reports about printer menu settings, status, and event logs.
<b>Supply Usage And Counters</b> Clear Supply Usage History	Reset the supply page counter or view the total printed pages.
<b>Printer Emulations</b> PPDS Emulation Off* On	Set the printer to recognize and use the PPDS data stream.
<b>Printer Emulations</b> PS Emulation Off On*	Set the printer to recognize and use the PS data stream.
<b>Printer Emulations</b> Emulator Security Page Timeout 0–60 (60*)	Set the page timeout during emulation.
<b>Note:</b> An asterisk (*) next to a value indicates the factory default setting.	



Menu item	Description
<b>Printer Emulations</b> Emulator Security Reset Emulator After Job Off* On	Reset the emulator after a print job.
<b>Printer Emulations</b> Emulator Security Disable Printer Message Access Off On*	Disable access to printer message during emulation.
<b>Fax Configuration</b> Fax Low Power Support Disable Sleep Permit Sleep Auto*	Set fax to enter Sleep mode whenever the printer determines that it should.  <b>Note:</b> This menu item appears only in some printer models.
<b>Fax Configuration</b> Fax Storage Location NAND Disk*	Set the storage location for all faxes.  <b>Notes:</b> <ul style="list-style-type: none"> <li>• This menu item appears only when a hard disk is installed.</li> <li>• This menu item appears only in some printer models.</li> </ul>
<b>Print Configuration</b> Font Sharpening 0–150 (24*)	Set a text point-size value below which the high-frequency screens are used when printing font data.  For example, if the value is 24, then all fonts sized 24 points or less use the high-frequency screens.
<b>Print Configuration</b> Print Density 1–5 (3*) Copy Density 1–5 (3*)	Adjust the toner density when printing or copying documents.
<b>Print Configuration</b> A4 Fuser Compress* Clip	Set the fuser behavior when printing on a letter-size paper.
<b>Device Operations</b> Quiet Mode Off* On	Set the printer to operate in Quiet Mode.  <b>Note:</b> Enabling this setting slows down the overall performance of the printer.
<b>Note:</b> An asterisk (*) next to a value indicates the factory default setting.	

Menu item	Description
<b>Device Operations</b> Safe Mode Off* On	Set the printer to operate in a special mode, in which it attempts to continue offering as much functionality as possible, despite known issues.  For example, when set to On, and the duplex motor is nonfunctional, the printer performs one-sided printing of the documents even if the job is two-sided printing.
<b>Device Operations</b> Minimum Copy Memory 20 MB* 30 MB 50 MB 80 MB 100 MB	Set the minimum memory allocation for storing copy jobs.
<b>Device Operations</b> Clear Custom Status	Erase user-defined strings for the Default or Alternate custom messages.
<b>Device Operations</b> Clear all remotely-installed messages	Erase messages that were remotely installed.
<b>Device Operations</b> Automatically Display Error Screens Off On*	Show existing error messages on the display after the printer remains inactive on the home screen for a length of time equal to the Screen Timeout setting.
<b>Device Operations</b> Honor orientation on fast path copy Off* On	Enable the printer to use the orientation setting under the Copy menu when sending quick copy jobs.
<b>App Configuration</b> LES Applications Off On*	Enable the Lexmark Embedded Solutions (LES) applications.  <b>Notes:</b> <ul style="list-style-type: none"> <li>• When set to On, this setting does not affect built-in applications.</li> <li>• This menu item appears only in the Embedded Web Server.</li> </ul>
<b>Scanner Configuration</b> Scanner Manual Registration Print Quick Test	Print a Quick Test target page.  <b>Note:</b> Make sure that the margin spacing on the target page is uniform all the way around the target. If it is not, then the printer margins must be reset.
<b>Scanner Configuration</b> Scanner Manual Registration Front ADF Registration Rear ADF Registration Flatbed Registration	Manually register the flatbed and ADF after replacing the ADF, scanner glass, or controller board.
<b>Note:</b> An asterisk (*) next to a value indicates the factory default setting.	

Menu item	Description
<b>Scanner Configuration</b> Reset Maintenance Counter Resetting ADF Maintenance Counter	Reset the counter after replacing the ADF maintenance kit.
<b>Scanner Configuration</b> Edge Erase Flatbed Edge Erase (3*) ADF Edge Erase (3*)	Set the size, in millimeters, of the no-print area around an ADF or flatbed scan job.
<b>Scanner Configuration</b> ADF Deskew ADF Electronic Deskew(On*)	Reduce skewing of documents that are scanned from the ADF.
<b>Scanner Configuration</b> Disable Scanner Enabled* Disabled ADF Disabled	Disable the scanner when it is not working properly.
<b>Scanner Configuration</b> Tiff Byte Order CPU Endianness* Little Endian Big Endian	Set the byte order of a TIFF-formatted scan output.
<b>Scanner Configuration</b> Exact Tiff Rows Per Strip On* Off	Set the RowsPerStrip tag value of a TIFF-formatted scan output.
<b>Note:</b> An asterisk (*) next to a value indicates the factory default setting.	

### Out of Service Erase

Menu item	Description
<b>Out of Service Erase</b> Memory Last Sanitized Hard Disk Last Sanitized	Show information on when the printer memory or hard disk was last sanitized.  <b>Note:</b> Hard Disk Last Sanitized appears only when a hard disk is installed.
<b>Out of Service Erase</b> Sanitize all information on nonvolatile memory Erase all printer and network settings Erase all apps and app settings Erase all shortcuts and shortcut settings Sanitize all information on hard disk Erase downloads (Erase all macros, fonts, PPOs, etc.) Erase buffered jobs Erase Held jobs	Clear all information on non-volatile memory and information on the hard disk.  <b>Note:</b> Sanitize all information on hard disk appears only when a hard disk is installed.

## Visible Home Screen Icons

Menu	Description
<p><b>Visible Home Screen Icons</b></p> <ul style="list-style-type: none"> <li>Copy</li> <li>E-mail</li> <li>Fax</li> <li>Status/Supplies</li> <li>Job Queue</li> <li>Change Language</li> <li>Shortcut Center</li> <li>Address Book</li> <li>Bookmarks</li> <li>Held Jobs</li> <li>USB</li> <li>FTP</li> <li>Scan Profiles</li> <li>App Profiles</li> <li>Display Customization</li> <li>Scan Center</li> <li>Card Copy</li> </ul>	<p>Specify which icons to show on the home screen.</p>

## About this Printer

Menu item	Description
<b>Asset Tag</b>	Show the serial number of the printer.
<b>Printer's Location</b>	Identify the printer location. The maximum length is 63 characters.
<b>Contact</b>	Personalize the printer name. The maximum length is 63 characters.
<b>Export Configuration File to USB</b>	Export the configuration file to a flash drive.
<b>Export Compressed Logs to USB</b>	Export the compressed log files to a flash drive.
<p><b>Send Logs</b></p> <ul style="list-style-type: none"> <li>Cancel</li> <li>Send</li> </ul>	Send diagnostic information to Lexmark.

# Print

## Layout

Menu item	Description
<b>Sides</b> 1-Sided* 2-Sided	Specify whether to print on one side or both sides of the paper.
<b>Flip Style</b> Long Edge* Short Edge	Determine which side of the paper is bound when performing two-sided printing.
<b>Blank Pages</b> Print Do Not Print*	Print blank pages that are included in a print job.
<b>Collate</b> Off (1,1,1,2,2,2) On (1,2,1,2,1,2)*	Keep the pages of a print job stacked in sequence, particularly when printing multiple copies of the job.
<b>Separator Sheets</b> None* Between Copies Between Jobs Between Pages	Insert blank separator sheets when printing.
<b>Separator Sheet Source</b> Tray [x] (1*) Multipurpose Feeder	Specify the paper source for the separator sheet.
<b>Pages per Side</b> Off* 2 pages per side 3 pages per side 4 pages per side 6 pages per side 9 pages per side 12 pages per side 16 pages per side	Print multiple page images on one side of a sheet of paper.
<b>Pages per Side Ordering</b> Horizontal* Reverse Horizontal Vertical Reverse Vertical	Specify the positioning of multiple page images when using the Pages per Side menu.
<b>Note:</b> An asterisk (*) next to a value indicates the factory default setting.	

Menu item	Description
<b>Pages per Side Orientation</b> Auto* Landscape Portrait	Specify the orientation of multiple page images when using the Pages per Side menu.
<b>Pages per Side Border</b> None* Solid	Print a border around each page image when using the Pages per Side menu.
<b>Copies</b> 1–9999 (1*)	Specify the number of copies for each print job.
<b>Print Area</b> Normal* Fit to page Whole Page	Set the printable area on a sheet of paper.

**Note:** An asterisk (\*) next to a value indicates the factory default setting.

## Finishing

Menu item	Description
<b>Staple Job</b> Off* 1 staple, top left corner 2 staples, left 1 staple, top right corner 2 staples, top 1 staple, bottom left corner 2 staples, bottom 1 staple, bottom right corner 2 staples, right	Specify the staple position for all print jobs. <b>Note:</b> This menu item appears only when a finisher is installed.
<b>Staple Test</b> Start	Determine whether the staple finisher is functioning properly. <b>Note:</b> This menu item appears only when a finisher is installed.
<b>Hole Punch</b> Off* On	Punch holes along the edge of the printed output. <b>Note:</b> This menu item appears only when a multiposition staple, hole punch finisher is installed.
<b>Hole Punch Mode</b> 2 holes 3 holes 4 holes	Set the hole punch mode for the printed output. <b>Notes:</b> <ul style="list-style-type: none"> <li>• 3 holes is the U.S. factory default setting. 4 holes is the international factory default setting.</li> <li>• This menu item appears only when a multiposition staple, hole punch finisher is installed.</li> </ul>

**Note:** An asterisk (\*) next to a value indicates the factory default setting.

Menu item	Description
<b>Offset Pages</b> None* Between Copies Between Jobs	Offset the output of each print job or each copy of a print job.  <b>Notes:</b> <ul style="list-style-type: none"> <li>Between Copies offsets each copy of a print job if Collate is set to On [1,2,1,2,1,2]. If Collate is set to Off [1,1,1,2,2,2], then each set of printed pages is offset, such as all page 1s and all page 2s.</li> <li>Between Jobs sets the same offset position for the entire print job regardless of the number of copies printed.</li> <li>This menu item appears only when a multiposition staple, hole punch finisher is installed.</li> </ul>
<b>Note:</b> An asterisk (*) next to a value indicates the factory default setting.	

## Setup

Menu item	Description
<b>Printer Language</b> PCL Emulation* PS Emulation	Set the printer language.  <b>Note:</b> Setting a printer language default does not prevent a software program from sending print jobs that use another printer language.
<b>Job Waiting</b> Off* On	Preserve print jobs requiring supplies so that jobs not requiring the missing supplies can print.  <b>Note:</b> This menu item appears only when a hard disk is installed.
<b>Job Hold Timeout</b> 0–255 (30*)	Set the time in seconds that the printer waits for user intervention before it holds jobs that require unavailable resources and continues to print other jobs in the print queue.  <b>Note:</b> This menu item appears only when a hard disk is installed.
<b>Download Target</b> RAM* Disk	Specify where to save all permanent resources, such as fonts and macros, that have been downloaded to the printer.  <b>Note:</b> This menu item appears only when a hard disk is installed.
<b>Resource Save</b> Off* On	Determine what the printer does with downloaded resources, such as fonts and macros, when it receives a job that requires more than the available memory.  <b>Notes:</b> <ul style="list-style-type: none"> <li>When set to Off, the printer retains downloaded resources only until memory is needed. Resources associated with the inactive printer language are deleted.</li> <li>When set to On, the printer preserves all the permanent downloaded resources across all language switches. When necessary, the printer shows memory full messages instead of deleting permanent resources.</li> </ul>
<b>Note:</b> An asterisk (*) next to a value indicates the factory default setting.	

Menu item	Description
<b>Print All Order</b> Alphabetical* Newest First Oldest First	Specify the order in which held and confidential jobs are printed when Print All is selected.  <b>Note:</b> This menu item appears only when a hard disk is installed.
<b>Note:</b> An asterisk (*) next to a value indicates the factory default setting.	

## Quality

Menu item	Description
<b>Print Resolution</b> 300 dpi 600 dpi* 1200 dpi 1200 Image Q 2400 Image Q	Set the resolution for the text and images on the printed output.  <b>Note:</b> Resolution is determined in dots per inch or image quality.
<b>Pixel Boost</b> Off* Fonts Horizontally Vertically Both directions	Enable more pixels to print in clusters for clarity, in order to enhance text and images.
<b>Toner Darkness</b> 1 to 10 (8*)	Determine the lightness or darkness of text images.
<b>Halftone</b> Normal* Detail	Enhance the printed output to have smoother lines with sharper edges.
<b>Brightness</b> -6 to 6 (0*)	Adjust the brightness of the printed output.
<b>Contrast</b> 0 to 5 (0*)	Adjust the contrast of the printed output.
<b>Gray Correction</b> Auto* Normal	Adjust the contrast enhancement applied to images.
<b>Note:</b> An asterisk (*) next to a value indicates the factory default setting.	



## Job Accounting

Menu item	Description
<b>Job Accounting</b> Off* On	Set the printer to create a log of the print jobs that it receives. <b>Note:</b> This menu item appears only when a flash memory or hard disk is installed.
<b>Accounting Log Frequency</b> Daily Weekly Monthly*	Specify how often the printer creates a log file.
<b>Log Action at End of Frequency</b> None* E-mail Current Log E-mail & Delete Current Log Post Current Log Post & Delete Current Log	Specify how the printer responds when the frequency threshold expires. <b>Note:</b> The value defined in Accounting Log Frequency determines when this action is triggered.
<b>Log Near Full Level</b> Off On (5)*	Specify the maximum size of the log file before the printer executes the Log Action at Near Full. <b>Note:</b> This menu item appears only when a flash memory or hard disk is installed.
<b>Log Action at Near Full</b> None* E-mail Current Log E-mail & Delete Current Log E-mail & Delete Oldest Log Post Current Log Post & Delete Current Log Post & Delete Oldest Log Delete Current Log Delete Oldest Log Delete All But Current Delete All Logs	Specify how the printer responds when the hard disk is nearly full. <b>Note:</b> The value defined in Log Near Full Level determines when this action is triggered.
<b>Log Action at Full</b> None* E-mail & Delete Current Log E-mail & Delete Oldest Log Post & Delete Current Log Post & Delete Oldest Log Delete Current Log Delete Oldest Log Delete All But Current Delete All Logs	Specify how the printer responds when hard disk usage reaches the maximum limit (100MB).
<b>URL to Post Log</b>	Specify where the printer posts job accounting logs.
<b>Note:</b> An asterisk (*) next to a value indicates the factory default setting.	

Menu item	Description
<b>E-mail Address to Send Logs</b>	Specify the e-mail address to which the printer sends job accounting logs.
<b>Log File Prefix</b>	Specify the prefix for the log files. <b>Note:</b> The current host name defined in the TCP/IP menu is used as the default log file prefix.
<b>Note:</b> An asterisk (*) next to a value indicates the factory default setting.	

## XPS

Menu item	Description
<b>Print Error Pages</b> Off* On	Print a test page that contains information on errors.
<b>Minimum Line Width</b> 1–30 (2*)	Set the minimum stroke width of any job printed in 1200 dpi.
<b>Note:</b> An asterisk (*) next to a value indicates the factory default setting.	

## PDF

Menu item	Description
<b>Scale To Fit</b> Off* On	Scale the page content to fit the selected paper size.
<b>Annotations</b> Print Do Not Print*	Specify whether to print annotations in the PDF.
<b>Print PDF Error</b> Off On*	Enable the printing of PDF error.
<b>Note:</b> An asterisk (*) next to a value indicates the factory default setting.	

## PostScript

Menu item	Description
<b>Print PS Error</b> Off* On	Print a page that describes the PostScript® error. <b>Note:</b> When an error occurs, processing of the job stops, the printer prints an error message, and the rest of the print job is flushed.
<b>Note:</b> An asterisk (*) next to a value indicates the factory default setting.	

Menu item	Description
<b>Minimum Line Width</b> 1–30 (2*)	Set the minimum stroke width. <b>Notes:</b> <ul style="list-style-type: none"> <li>Jobs printed in 1200 dpi use the value directly.</li> <li>Jobs printed in 4800 CQ use half the value.</li> </ul>
<b>Lock PS Startup Mode</b> Off On*	Disable the SysStart file.
<b>Image Smoothing</b> Off* On	Enhance the contrast and sharpness of low-resolution images. <b>Note:</b> This setting has no effect on images with a resolution of 300 dpi or higher.
<b>Font Priority</b> Resident* Flash/Disk	Establish the font search order. <b>Notes:</b> <ul style="list-style-type: none"> <li>Resident sets the printer to search its memory for the requested font before searching the flash memory or printer hard disk.</li> <li>Flash/Disk sets the printer to search the flash memory or printer hard disk for the requested font before searching the printer memory.</li> <li>This menu item appears only when a flash memory or hard disk is installed.</li> </ul>
<b>Wait Timeout</b> Off On* (40 seconds)	Enable the printer to wait for more data before canceling a print job.
<b>Note:</b> An asterisk (*) next to a value indicates the factory default setting.	

## PCL

Menu item	Description
<b>Font Source</b> Resident* Disk Flash All	Choose the source which contains the default font selection. <b>Notes:</b> <ul style="list-style-type: none"> <li>Flash and Disk appear only when a flash memory or hard disk is installed.</li> <li>For Flash and Disk to appear, make sure that they are not read- or write-protected.</li> </ul>
<b>Font Name</b> Courier*	Select a font from the specified font source.
<b>Symbol Set</b> 10U PC-8*	Specify the symbol set for each font name. <b>Note:</b> A symbol set is a set of alphabetic and numeric characters, punctuation, and special symbols. Symbol sets support the different languages or specific programs such as math symbols for scientific text.
<b>Note:</b> An asterisk (*) next to a value indicates the factory default setting.	

Menu item	Description
<b>Pitch</b> 0.08–100 (10*)	Specify the pitch for fixed or monospaced fonts. <b>Note:</b> Pitch refers to the number of fixed-space characters in a horizontal inch of type.
<b>Orientation</b> Portrait* Landscape Reverse Portrait* Reverse Landscape	Specify the orientation of text and graphics on the page.
<b>Lines per Page</b> 1–255	Specify the number of lines of text for each page printed through the PCL® data stream. <b>Notes:</b> <ul style="list-style-type: none"> <li>• This menu item activates vertical escapement that causes the selected number of requested lines to print between the default margins of the page.</li> <li>• 60 is the U.S. factory default setting. 64 is the international factory default setting.</li> </ul>
<b>PCL5 Minimum Line Width</b> 1–30 (2*)	Set the initial minimum stroke width of any job printed in 1200 dpi.
<b>PCLXL Minimum Line Width</b> 1–30 (2*)	
<b>A4 Width</b> 198 mm* 203 mm	Set the width of the logical page on A4-size paper. <b>Note:</b> Logical page is the space on the physical page where data is printed.
<b>Auto CR after LF</b> Off* On	Set the printer to perform a carriage return after a line feed control command. <b>Note:</b> Carriage return is a mechanism that commands the printer to move the position of the cursor to the first position on the same line.
<b>Auto LF after CR</b> Off* On	Set the printer to perform a line feed after a carriage return control command.
<b>Tray Renumber</b> Assign MP Feeder Assign Tray [x] Assign Manual Paper Assign Manual Envelope View Factory Defaults Restore Defaults	<ul style="list-style-type: none"> <li>• Configure the printer to work with a different print driver or custom application that uses a different set of source assignments to request a given paper source.</li> <li>• Show the factory default value assigned for each paper source.</li> <li>• Restore the tray renumber values to their factory defaults.</li> </ul>
<b>Print Timeout</b> Off On* (90 seconds)	Set the printer to end a print job after it has been idle for the specified amount of time.
<b>Note:</b> An asterisk (*) next to a value indicates the factory default setting.	

## HTML

Menu item	Description
<b>Font Name</b> Times*	Set the font to use when printing HTML documents.
<b>Font Size</b> 1–255 (12*)	Set the font size to use when printing HTML documents.
<b>Scale</b> 1–400% (100*)	Scale HTML documents for printing.
<b>Orientation</b> Portrait* Landscape	Set the page orientation for HTML documents.
<b>Margin Size</b> 8–255 mm (19*)	Set the page margin for HTML documents.
<b>Backgrounds</b> Do Not Print Print*	Print background information or graphics in HTML documents.
<b>Note:</b> An asterisk (*) next to a value indicates the factory default setting.	

## Image

Menu item	Description
<b>Auto Fit</b> On Off*	Select the best available paper size and orientation setting for an image. <b>Note:</b> When set to On, this menu item overrides the scaling and orientation settings for the image.
<b>Invert</b> Off* On	Invert bitonal monochrome images. <b>Note:</b> This menu item does not apply to GIF or JPEG image formats.
<b>Scaling</b> Anchor Top Left Best Fit* Anchor Center Fit Height/Width Fit Height Fit Width	Adjust the image to fit the printable area. <b>Note:</b> When Auto Fit is set to On, Scaling is automatically set to Best Fit.
<b>Orientation</b> Portrait* Landscape Reverse Portrait Reverse Landscape	Specify the orientation of text and graphics on the page.
<b>Note:</b> An asterisk (*) next to a value indicates the factory default setting.	

# Paper

## Tray Configuration

Menu item	Description
<b>Default Source</b> Tray [x] (1*) Multipurpose Feeder Manual Paper Manual Envelope	Set the paper source for all print jobs.
<b>Paper Size/Type</b> Tray [x] Multipurpose Feeder Manual Paper Manual Envelope	Specify the paper size or paper type loaded in each paper source.
<b>Substitute Size</b> Off Statement/A5 Letter/A4 All Listed*	Set the printer to substitute a specified paper size if the requested size is not loaded in any paper source.  <b>Notes:</b> <ul style="list-style-type: none"> <li>• Off prompts the user to load the required paper size.</li> <li>• Statement/A5 prints A5-size document on statement when loading statement and statement-size jobs on A5 paper size when loading A5. Statement/A5 appears only in the Embedded Web Server.</li> <li>• Letter/A4 prints A4-size document on letter when loading letter and letter-size jobs on A4 paper size when loading letter.</li> <li>• All Listed substitutes Letter/A4.</li> </ul>
<b>Configure MP</b> Cassette* Manual First	Determine the behavior of the multipurpose feeder.  <b>Notes:</b> <ul style="list-style-type: none"> <li>• Cassette configures the multipurpose feeder as the automatic paper source.</li> <li>• Manual sets the multipurpose feeder only for manual-feed print jobs.</li> <li>• First configures the multipurpose feeder as the primary paper source.</li> </ul>
<b>Note:</b> An asterisk (*) next to a value indicates the factory default setting.	

## Media Configuration

### Universal Setup

Menu item	Description
<b>Units of Measure</b> Inches Millimeters	Specify the unit of measurement for the universal paper.  <b>Note:</b> Inches is the U.S. factory default setting. Millimeters is the international factory default setting.
<b>Note:</b> An asterisk (*) next to a value indicates the factory default setting.	

Menu item	Description
<b>Portrait Width</b> 3–52 inches (8.5*) 76–1321 mm (216*)	Set the portrait width of the universal paper.
<b>Portrait Height</b> 3–52 inches (14*) 76.2–1321 mm (356*)	Set the portrait height of the universal paper.
<b>Feed Direction</b> Short Edge* Long Edge	Set the printer to pick paper from the short edge or long edge direction.  <b>Note:</b> Long Edge appears only when the longest edge is shorter than the maximum width supported.
<b>Note:</b> An asterisk (*) next to a value indicates the factory default setting.	

### Custom Scan Sizes

Menu item	Description
<b>Custom Scan Size [x]</b> Scan Size Name Width 1–8.5 inches (8.5*) 25.4–215.9 mm (215.9*) Height 1–25 inches (14*) 25.4–635 mm (355.6*) Orientation Portrait* Landscape 2 scans per side Off* On	Assign a scan size name and configure the scan settings.

## Media Types

Menu item	Description
Plain Card Stock Transparency Recycled Labels Vinyl Labels Bond Envelope Rough Envelope Letterhead Preprinted Colored Paper Light Heavy Rough/Cotton Custom Type [X]	Specify the texture, weight, and orientation of the paper.

## Bin Configuration

Menu item	Description
<b>Output Bin</b> Standard Bin* Bin [x]	Specify the output bin.
<b>Configure Bins</b> Mailbox* Link Link Optional Type Assignment	Configure the mode of operation for the output bins. <b>Notes:</b> <ul style="list-style-type: none"> <li>• Mailbox allows the standard bin and any optional bin to be selected individually.</li> <li>• Link allows all output bins to be linked together as though they were one large bin.</li> <li>• Link Optional treats all optional bins as one large output bin.</li> <li>• Type Assignment assigns each paper type a bin or a linked bin set.</li> </ul>
<b>Custom Bin Names</b> Standard Bin Bin [x]	Assign a name for the bin.
<b>Note:</b> An asterisk (*) next to a value indicates the factory default setting.	



# Copy

## Copy Defaults

Menu item	Description
<b>Content Type</b> Text Text/Photo* Photo Graphics	Improve the output result based on the content of the original document.
<b>Content Source</b> Black and White Laser* Color Laser Inkjet Photo/Film Magazine Newspaper Press Other	Improve the output result based on the source of the original document.
<b>Sides</b> 1 sided to 1 sided* 1 sided to 2 sided 2 sided to 1 sided 2 sided to 2 sided	Specify the scanning behavior based on the original document.
<b>Separator Sheets</b> None* Between Copies Between Jobs Between Pages	Specify whether to insert blank separator sheets when printing.
<b>Separator Sheet Source</b> Tray [x] (1*) Multipurpose Feeder	Specify the paper source for the separator sheet.
<b>Pages per Side</b> Off* 2 Portrait pages 4 Portrait pages 2 Landscape pages 4 Landscape pages	Specify the number of page images to print on one side of a sheet of paper.
<b>Print Page Borders</b> Off* On	Place a border around each image when printing multiple pages on a single page.
<b>Note:</b> An asterisk (*) next to a value indicates the factory default setting.	

Menu item	Description
<b>Collate</b> Off [1,1,1,2,2,2] On [1,2,1,2,1,2]*	Print multiple copies in sequence.
<b>Offset Pages</b> None* Between Copies Between Jobs	Offset the output of each print job or each copy of a print job. <b>Notes:</b> <ul style="list-style-type: none"> <li>• Between Copies offsets each copy of a print job if Collate is set to On [1,2,1,2,1,2]. If Collate is set to Off [1,1,1,2,2,2], then each set of printed pages are offset, such as all page 1s and all page 2s.</li> <li>• Between Jobs sets the same offset position for the entire print job regardless of the number of copies printed.</li> <li>• This menu item appears only when a staple finisher is installed.</li> </ul>
<b>Staple</b> Off* 1 staple, top left corner 2 staples, left 1 staple, top right corner 2 staples, top 1 staple, bottom left corner 2 staples, bottom 1 staple, bottom right corner 2 staples, right	Specify the staple position for all print jobs. <b>Note:</b> This menu item appears only when a staple finisher is installed.
<b>Punch</b> Off* 2 holes 3 holes	Set the punch mode for all print jobs. <b>Note:</b> This menu item appears only when a staple finisher is installed.
<b>“Copy from” Size</b>	Set the paper size of the original document. <b>Note:</b> Letter is the U.S. factory default setting. A4 is the international factory default setting.
<b>“Copy to” Source</b> Tray [x] (1*) Multipurpose Feeder Auto Size Match	Specify the paper source for the copy job.
<b>Darkness</b> 1 to 9 (5*)	Adjust the darkness of the scanned image.
<b>Number of Copies</b> 1–9999 (1*)	Specify the number of copies.
<b>Note:</b> An asterisk (*) next to a value indicates the factory default setting.	

Menu item	Description
<b>Header/Footer</b> Left Header Middle Header Right Header Left Footer Middle Footer Right Footer	Specify the header or footer information on the scanned image.
<b>Overlay</b> Confidential Copy Draft Urgent Custom Off*	Specify the overlay text to print on each copy.
<b>Custom overlay</b>	Type the text for the Custom choice in Overlay menu.
<b>Note:</b> An asterisk (*) next to a value indicates the factory default setting.	

### Advanced Imaging

Menu item	Description
<b>Color Dropout</b> Color Dropout (None*) Default Red Threshold (128*) Default Green Threshold (128*) Default Blue Threshold (128*)	Specify which color to drop during scanning, and adjust the dropout setting for that color.
<b>Contrast</b> Best for content* 0–5	Specify the contrast for the scanned image.
<b>Background Removal</b> Background Detection (Content-based*) Level (0*)	Remove the background color or image noise from the original document.  <b>Notes:</b> <ul style="list-style-type: none"> <li>• Content-based removes the background color from the original document .</li> <li>• Fixed removes image noise from a photo.</li> </ul>
<b>Auto Center</b> Off* On	Align the content at the center of the page.
<b>Mirror Image</b> Off* On	Create a mirror image of the original document.
<b>Note:</b> An asterisk (*) next to a value indicates the factory default setting.	

Menu item	Description
<b>Negative Image</b> Off* On	Create a negative image of the original document.
<b>Shadow Detail</b> -4 to 4 (0*)	Adjust the shadow detail in the original document.
<b>Scan Edge to Edge</b> Off* On	Scan the original document from edge to edge.
<b>Sharpness</b> 1–5 (3*)	Adjust the sharpness of the scanned image.
<b>Note:</b> An asterisk (*) next to a value indicates the factory default setting.	

### Admin Controls

Menu item	Description
<b>Transparency Separators</b> Off On*	Insert a blank sheet between transparencies.
<b>Allow Priority Copies</b> Off On*	Interrupt a print job to make copies.
<b>Custom Job Scanning</b> Off* On	Set the printer to scan the first set of original documents using the specified settings, and then scan the next set with the same or different settings. <b>Note:</b> This menu item appears only when a hard disk is installed.
<b>Allow Save as Shortcut</b> Off On*	Save copy settings as a shortcut.
<b>Adjust ADF Skew</b> Off* On	Set the printer to adjust the skewed images from documents that are scanned from the ADF.
<b>Sample copy</b> Off* On	Print a sample copy to check the quality before printing the remaining copies. <b>Note:</b> This menu item appears only when a hard disk is installed.
<b>Note:</b> An asterisk (*) next to a value indicates the factory default setting.	

# Fax

## Fax Defaults

### Fax Mode

Menu item	Description
<b>Fax Mode</b> Fax Fax Server Disabled	Select a fax mode. <b>Note:</b> Depending on your printer model, the factory default setting may vary.

### Fax Setup

#### General Fax settings

Menu item	Description
<b>Fax Name</b>	Identify your fax machine.
<b>Fax Number</b>	Identify your fax number.
<b>Fax ID</b> Fax Name Fax Number*	Notify fax recipients of your fax name or fax number.
<b>Memory Use</b> All receive Mostly receive Equal* Mostly send All send	Set the amount of internal printer memory allocated for faxing. <b>Note:</b> This menu item prevents memory buffer conditions and failed faxes.
<b>Cancel Faxes</b> Allow* Don't Allow	Cancel outgoing faxes before they are transmitted, or cancel incoming faxes before they finish printing.
<b>Fax Number Masking</b> Off* From Left From Right	Specify the format for masking an outgoing fax number.
<b>Digits to Mask</b> 0–58 (0*)	Specify the number of digits to mask in an outgoing fax number.
<b>Enable Line Connected Detection</b> On* Off	Determine whether a telephone line is connected to the printer. <b>Note:</b> Detection takes place when turning on the printer and before each call.
<b>Note:</b> An asterisk (*) next to a value indicates the factory default setting.	

Menu item	Description
<b>Optimize Fax Compatibility</b>	Configure the printer fax functionality for optimal compatibility with other fax machines.
<b>Fax Transport</b> T.38 Analog G.711 etherFAX	Set the fax transport method.  <b>Notes:</b> <ul style="list-style-type: none"> <li>• This menu item appears only if an etherFAX or Fax over IP (FoIP) license bundle is installed in the printer.</li> <li>• Depending on your printer model, the factory default settings may vary.</li> </ul>
<b>Note:</b> An asterisk (*) next to a value indicates the factory default setting.	

### HTTPS Fax Settings

**Note:** This menu appears only if Fax Transport is set to etherFAX.

Menu item	Description
<b>HTTPS service URL</b>	Specify the etherFAX service URL.
<b>HTTPS Proxy</b>	Specify a proxy server URL.
<b>HTTPS Proxy User</b>	Specify the user name and password for the proxy server.
<b>HTTPS Proxy Password</b>	
<b>Fax Send Encryption</b> Disabled Enabled* Required	Enable encryption for outgoing fax messages.
<b>Fax Receive Encryption</b> Disabled Enabled* Required	Enable encryption for incoming fax messages.
<b>HTTPS Fax Status</b>	Show the etherFAX communication status.
<b>Note:</b> An asterisk (*) next to a value indicates the factory default setting.	

### Fax Send Settings

Menu item	Description
<b>Resolution</b> Standard* Fine Super Fine Ultra Fine	Set the resolution of the scanned image.  <b>Note:</b> A higher resolution increases fax transmission time and requires more memory.
<b>Original Size</b> [List of paper sizes] (Mixed Sizes*)	Specify the size of the original document.
<b>Note:</b> An asterisk (*) next to a value indicates the factory default setting.	

Menu item	Description
<b>Orientation</b> Portrait* Landscape	Specify the orientation of the original document. <b>Note:</b> This menu item appears only in some printer models.
<b>Sides</b> Off* Short Edge Long Edge	Specify the orientation of the original document when scanning on both sides of the document. <b>Note:</b> This menu item appears only in some printer models.
<b>Content Type</b> Text* Text/Photo Photo Graphics	Improve the output result based on the content of the original document.
<b>Content Source</b> Black and White Laser* Color Laser Inkjet Photo/Film Magazine Newspaper Press Other	Improve the output result based on the source of the original document.
<b>Darkness</b> 1–9 (5*)	Adjust the darkness of the scanned image.
<b>Behind a PABX</b> On Off*	Set the printer to dial a fax number without waiting to recognize the dial tone. <b>Note:</b> Private Automated Branch Exchange (PABX) is a telephone network that allows a single access number to offer multiple lines to outside callers.
<b>Dial Mode</b> Tone* Pulse	Specify the dial mode for incoming or outgoing faxes.
<b>Note:</b> An asterisk (*) next to a value indicates the factory default setting.	

### Advanced Imaging

Menu item	Description
<b>Color Balance</b> Cyan - Red -4 to 4 (0*) Magenta - Green -4 to 4 (0*) Yellow - Blue -4 to 4 (0*)	Adjust the color intensity during scanning.
<b>Note:</b> An asterisk (*) next to a value indicates the factory default setting.	

Menu item	Description
<b>Color Dropout</b> Color Dropout (None*) Default Red Threshold (128*) Default Green Threshold (128*) Default Blue Threshold (128*)	Specify which color to drop during scanning, and adjust the dropout setting for that color.
<b>Contrast</b> Best for Content* 0 1 2 3 4 5	Set the contrast of the output.
<b>Background Removal</b> Level -4 to 4 (0*)	Adjust the amount of background visible on a scanned image.
<b>Mirror Image</b> Off* On	Create a mirror image of the original document.
<b>Negative Image</b> Off* On	Create a negative image of the original document.
<b>Shadow Detail</b> -4 to 4 (0*)	Adjust the amount of shadow detail visible on a scanned image.
<b>Scan Edge to Edge</b> On Off*	Allow edge-to-edge scanning of the original document.
<b>Sharpness</b> 1–5 (3*)	Adjust the sharpness of the scanned image.
<b>Temperature</b> -4 to 4 (0*)	Specify whether to generate a cooler or warmer output.
<b>Note:</b> An asterisk (*) next to a value indicates the factory default setting.	



**Admin Controls**

Menu item	Description
<b>Enable Color Fax Scans</b> Off by Default* On by Default Never Use Always Use	Enable color scans for fax.
<b>Automatic Redial</b> 0–9 (5*)	Adjust the number of redial attempts based on the activity levels of recipient fax machines.
<b>Redial Frequency</b> 1–200 minutes (3*)	Increase the time between redial attempts to increase the chance of sending fax successfully.
<b>Enable ECM</b> On* Off	Activate Error Correction Mode (ECM) for fax jobs. <b>Note:</b> ECM detects and corrects errors in the fax transmission process caused by telephone line noise and poor signal strength.
<b>Enable Fax Scans</b> On* Off	Fax documents that are scanned at the printer.
<b>Driver to Fax</b> On* Off	Allow the print driver to send fax.
<b>Allow Save as Shortcut</b> On* Off	Save fax numbers as shortcuts on the printer.
<b>Max Speed</b> 33600* 14400 9600 4800 2400	Set the maximum speed for sending fax.
<b>Custom Job Scanning</b> Off* On	Turn on scanning of custom jobs by default. <b>Note:</b> This menu item appears only when a hard disk is installed.
<b>Scan Preview</b> Off* On	Show a preview of the scan on the display. <b>Note:</b> This menu item appears only when a hard disk is installed.
<b>Adjust ADF Skew</b> Off* On	Correct slight skew in the scanned image.
<b>Note:</b> An asterisk (*) next to a value indicates the factory default setting.	

Menu item	Description
<b>Auto Convert Color Faxes to Mono Faxes</b> On* Off	Convert all outgoing color faxes to black and white.
<b>Confirm Fax Number</b> Off* On	Ask the user to confirm the fax number.
<b>Dial Prefix</b>	Set a dialing prefix.
<b>Dialing Prefix Rules</b>	Establish a dialing prefix rule.
<b>Note:</b> An asterisk (*) next to a value indicates the factory default setting.	

### Fax Receive Settings

Menu item	Description
<b>Fax Job Waiting</b> None* Toner Toner and Supplies	Remove fax jobs that request specific unavailable resources from the print queue.
<b>Rings to Answer</b> 1–25 (3*)	Set the number of rings for incoming fax.
<b>Auto Reduction</b> On* Off	Scale incoming fax to fit on the page.
<b>Paper Source</b> Tray [X] Auto*	Set the paper source for printing incoming fax.
<b>Sides</b> On Off*	Print on both sides of the paper.
<b>Separator Sheets</b> None* Before Job After Job	Specify whether to insert blank separator sheets when printing.
<b>Separator Sheet Source</b> Tray [X] (1*)	Specify the paper source for the separator sheet.
<b>Output Bin</b> Standard Bin	Specify the output bin for received faxes.
<b>Fax Footer</b> On Off*	Print the transmission information at the bottom of each page from a received fax.
<b>Note:</b> An asterisk (*) next to a value indicates the factory default setting.	

Menu item	Description
<b>Fax Footer Time Stamp</b> Receive* Print	Print the time stamp at the bottom of each page from a received fax.
<b>Staple</b> Off* 1 staple 2 staples	Staple the printed fax document. <b>Note:</b> This menu item appears only when a finisher is installed.
<b>Holding Faxes</b> Held Fax Mode Off* Always On Manual Scheduled	Hold received faxes from printing until they are released.
<b>Note:</b> An asterisk (*) next to a value indicates the factory default setting.	

**Admin Controls**

Menu item	Description
<b>Enable Fax Receive</b> On* Off	Set the printer to receive fax.
<b>Enable Color Fax Receive</b> On* Off	Set the printer to receive fax in color.
<b>Enable Caller ID</b> On Off*	Show the number that is sending the incoming fax.
<b>Block No Name Fax</b> On Off*	Block incoming faxes sent from devices with no station ID or fax ID specified.
<b>Banned Fax List</b> Add Banned Fax	Specify the phone numbers that you want to block.
<b>Answer On</b> All Rings* Single Ring Only Double Ring Only Triple Ring Only Single or Double Rings Only Single or Triple Rings Only Double or Triple Rings Only	Set a distinctive ring pattern for incoming fax.
<b>Note:</b> An asterisk (*) next to a value indicates the factory default setting.	

Menu item	Description
<b>Auto Answer</b> On* Off	Set the printer to receive fax automatically.
<b>Fax Forwarding</b> Print* Print and Forward Forward	Specify whether to forward received fax.
<b>Forward To</b> Destination 1 Destination 2	Specify where to forward received fax. <b>Note:</b> This menu item appears only when Fax Forwarding is set to Print and Forward or Forward.
<b>Max Speed</b> 33600* 14400 9600 4800 2400	Set the maximum speed for transmitting fax.
<b>Note:</b> An asterisk (*) next to a value indicates the factory default setting.	

### Fax Cover Page

Menu item	Description
<b>Fax Cover Page</b> Off by Default* On by Default Never Use Always Use	Configure the settings for the fax cover page.
<b>Include To field</b> Off* On	
<b>Include From field</b> Off* On	
<b>From</b>	
<b>Include Message Field</b> Off* On	
<b>Message:</b>	
<b>Include Logo</b> Off* On	
<b>Include Footer [x]</b> Off* On	
<b>Footer [x]</b>	
<b>Note:</b> An asterisk (*) next to a value indicates the factory default setting.	

### Fax Log settings

Menu item	Description
<b>Transmission Log Frequency</b> Always* Never Only for Error	Specify how often the printer creates a transmission log.
<b>Transmission Log Action</b> Print Off On* E-mail Off* On	
<b>Note:</b> An asterisk (*) next to a value indicates the factory default setting.	

Menu item	Description
<b>Receive Error Log</b> Print Never* Print on Error	Print a log for fax-receive failures.
<b>Auto Print Logs</b> On* Off	Print all fax activity.
<b>Log Paper Source</b> Tray [x] (1*)	Specify the paper source for printing logs.
<b>Logs Display</b> Remote Fax Name* Dialed Number	Identify the sender by remote fax name or fax number.
<b>Enable Job Log</b> On* Off	View a summary of all fax jobs.
<b>Enable Call Log</b> On* Off	View a summary of fax dialing history.
<b>Log Output Bin</b> Standard Bin* Bin [x]	Specify the output bin for printed logs.
<b>Note:</b> An asterisk (*) next to a value indicates the factory default setting.	

### Speaker settings

Menu item	Description
<b>Speaker Mode</b> Always Off* Always On On until Connected	Set the fax speaker mode.
<b>Speaker Volume</b> Low* High	Adjust the fax speaker volume.
<b>Ringer Volume</b> Off* On	Enable the ringer volume.
<b>Note:</b> An asterisk (*) next to a value indicates the factory default setting.	

## Fax Server Setup

### General Fax Settings

Menu item	Description
<b>To Format</b>	Specify a fax recipient. <b>Note:</b> If you want to use the fax number, then type the number sign (#) before a number.
<b>Reply Address</b>	Specify a reply address for sending fax.
<b>Subject</b>	Specify the fax subject and message.
<b>Message</b>	
<b>Enable analog receive</b> Off* On	Set the printer to receive analog faxes.
<b>Note:</b> An asterisk (*) next to a value indicates the factory default setting.	

### Fax Server E-mail Settings

Menu item	Description
<b>Use E-mail SMTP Server</b> On* Off	Use the Simple Mail Transfer Protocol (SMTP) settings for e-mail in receiving and sending faxes. <b>Note:</b> When set to On, all other settings of the Fax Server E-mail Settings menu are not shown.
<b>Primary SMTP Gateway</b>	Type the IP address or host name of the primary SMTP server.
<b>Primary SMTP Gateway Port</b> 1–65535 (25*)	Enter the port number of the primary SMTP server.
<b>Secondary SMTP Gateway</b>	Type the server IP address or host name of your secondary or backup SMTP server.
<b>Secondary SMTP Gateway Port</b> 1–65535 (25*)	Enter the server port number of your secondary or backup SMTP server.
<b>SMTP Timeout</b> 5–30 (30*)	Set the time before the printer times out if the SMTP server does not respond.
<b>Reply Address</b>	Specify a reply address for sending fax.
<b>Use SSL/TLS</b> Disabled* Negotiate Required	Specify whether to send fax using an encrypted link.
<b>Require Trusted Certificate</b> Off On*	Specify a trusted certificate when accessing the SMTP server.
<b>Note:</b> An asterisk (*) next to a value indicates the factory default setting.	

Menu item	Description
<b>SMTP Server Authentication</b> No authentication required* Login / Plain NTLM CRAM-MD5 Digest-MD5 Kerberos 5	Set the authentication type for the SMTP server.
<b>Device-Initiated E-mail</b> None* Use Device SMTP Credentials	Specify whether credentials are required for device-initiated e-mail.
<b>User-Initiated E-mail</b> None* Use Device SMTP Credentials Use Session User ID and Password Use Session E-mail address and Password Prompt user	Specify whether credentials are required for user-initiated e-mail.
<b>Use Active Directory Device Credentials</b> Off* On	Enable user credentials and group destinations to connect to the SMTP server.
<b>Device Userid</b>	Specify the user ID and password to connect to the SMTP server.
<b>Device Password</b>	
<b>Kerberos 5 REALM</b>	Specify the realm for the Kerberos 5 authentication protocol.
<b>NTLM Domain</b>	Specify the domain name for the NTLM security protocol.
<b>Disable "SMTP server not set up" error</b> Off* On	Hide the "SMTP server not set up" error message.
<b>Note:</b> An asterisk (*) next to a value indicates the factory default setting.	

**Fax Server Scan Settings**

Menu item	Description
<b>Image Format</b> TIFF (.tif) PDF (.pdf)* XPS (.xps)	Specify the file format for the scanned image.
<b>Note:</b> An asterisk (*) next to a value indicates the factory default setting.	



Menu item	Description
<b>Content Type</b> Text* Text/Photo Photo Graphics	Improve the output result based on the content of the original document.
<b>Content Source</b> Black and White Laser* Color Laser Inkjet Photo/Film Magazine Newspaper Press Other	Improve the output result based on the source of the original document.
<b>Fax Resolution</b> Standard* Fine Super Fine Ultra Fine	Set the fax resolution.
<b>Sides</b> Off* Short Edge Long Edge	Specify the orientation of the original document when scanning on both sides of the document.
<b>Darkness</b> 1–9 (5*)	Set the darkness of the output.
<b>Orientation</b> Portrait* Landscape	Specify the orientation of text and graphics on the page.
<b>Original Size</b> [List of paper sizes]	Set the paper size of the original document.  <b>Notes:</b> <ul style="list-style-type: none"> <li>• Mixed Sizes is the U.S. factory default setting. A4 is the international factory default setting.</li> <li>• This setting may vary depending on your printer model.</li> </ul>
<b>Use Multi-Page TIFF</b> Off On*	Choose between single- and multiple-page TIFF files.
<b>Note:</b> An asterisk (*) next to a value indicates the factory default setting.	

# E-mail

## E-mail Setup

Menu item	Description
<b>Primary SMTP Gateway</b>	Type the IP address or host name of the primary SMTP server for sending e-mail.
<b>Primary SMTP Gateway Port</b> 1–65535 (25*)	Enter the port number of the primary SMTP server.
<b>Secondary SMTP Gateway</b>	Type the server IP address or host name of your secondary or backup SMTP server.
<b>Secondary SMTP Gateway Port</b> 1–65535 (25*)	Enter the server port number of your secondary or backup SMTP server.
<b>SMTP Timeout</b> 5–30 seconds (30*)	Set the time before the printer times out if the SMTP server does not respond.
<b>Reply Address</b>	Specify a reply address in the e-mail.
<b>Always use SMTP default Reply Address</b> On Off*	Always use the default reply address in the SMTP server.
<b>Use SSL/TLS</b> Disabled* Negotiate Required	Specify whether to send e-mail using an encrypted link.
<b>Require Trusted Certificate</b> Off On*	Require a trusted certificate when accessing the SMTP server.
<b>SMTP Server Authentication</b> No authentication required* Login / Plain NTLM CRAM-MD5 Digest-MD5 Kerberos 5	Set the authentication type for the SMTP server.
<b>Device-Initiated E-mail</b> None* Use Device SMTP Credentials	Specify whether credentials are required for device-initiated e-mail.
<b>Note:</b> An asterisk (*) next to a value indicates the factory default setting.	

Menu item	Description
<b>User-Initiated E-mail</b> None* Use Device SMTP Credentials Use Session User ID and Password Use Session E-mail address and Password Prompt user	Specify whether credentials are required for user-initiated e-mail.
<b>Use Active Directory Device Credentials</b> Off* On	Specify whether credentials are required for user-initiated e-mail.
<b>Device Userid</b>	Specify the user ID and password to connect to the SMTP server.
<b>Device Password</b>	
<b>Kerberos 5 REALM</b>	Specify the realm for the Kerberos 5 authentication protocol.
<b>NTLM Domain</b>	Specify the domain name for the NTLM security protocol.
<b>Disable “SMTP server not set up” error</b> Off* On	Hide the “SMTP server not set up” error message.
<b>Note:</b> An asterisk (*) next to a value indicates the factory default setting.	

## E-mail Defaults

Menu item	Description
<b>Subject:</b>	Specify the e-mail subject and message.
<b>Message:</b>	
<b>File Name</b>	Specify the filename for the scanned document.
<b>Format</b> JPEG (.jpg) PDF (.pdf)* TIFF (.tif) XPS (.xps) TXT (.txt) RTF (.rtf) DOCX (.docx) CSV (.csv)	Specify the file format of the scanned document. <b>Note:</b> The menu items may vary depending on your printer model.
<b>Global OCR Settings</b> Recognized Languages Auto Rotate Despeckle Auto Contrast Enhance	Configure the settings for optical character recognition (OCR). <b>Note:</b> This menu item appears only if you have purchased and installed an OCR solution.
<b>Note:</b> An asterisk (*) next to a value indicates the factory default setting.	

Menu item	Description
<b>PDF Settings</b> PDF Version (1.5*) Archival Version (A-1a*) Highly Compressed (Off*) Secure (Off*) Archival (PDF/A) (Off*)	Configure the PDF settings of the scanned document.  <b>Notes:</b> <ul style="list-style-type: none"> <li>• Archival Version and Archival (PDF/A) are supported only when PDF Version is set to 1.4.</li> <li>• Highly Compressed appears only when a hard disk is installed.</li> </ul>
<b>Content Type</b> Text Text/Photo* Photo Graphics	Improve the output result based on the content type of the original document.
<b>Content Source</b> Black and White Laser* Color Laser Inkjet Photo/Film Magazine Newspaper Press Other	Improve the output result based on the content source of the original document.
<b>Color</b> Black and White Gray Color* Auto	Set the printer to capture file content in color or in mono.
<b>Resolution</b> 75 dpi 150 dpi* 200 dpi 300 dpi 400 dpi 600 dpi	Set the resolution of the scanned image.
<b>Darkness</b> 1–9 (5*)	Adjust the darkness of the scanned image.
<b>Orientation</b> Portrait* Landscape	Specify the orientation of the original document.
<b>Original Size</b> Mixed Sizes*	Set the paper size of the original document.
<b>Note:</b> An asterisk (*) next to a value indicates the factory default setting.	

Menu item	Description
<b>Sides</b> Off* Short Edge Long Edge	Specify the orientation of the original document when scanning on both sides of the document.
<b>Note:</b> An asterisk (*) next to a value indicates the factory default setting.	

### Advanced Imaging

Menu item	Description
<b>Color Balance</b> Cyan (0*) Magenta (0*) Yellow (0*)	Adjust the color intensity for cyan, magenta, and yellow.
<b>Color Dropout</b> Color Dropout None* Red Green Blue Default Red Threshold 0–255 (128*) Default Green Threshold 0–255 (128*) Default Blue Threshold 0–255 (128*)	Specify which color to drop during scanning, and adjust the dropout setting for that color.
<b>Auto Color Detect</b> Color Sensitivity 1–9 (5*) Area Sensitivity 1–9 (5*) E-mail Bit Depth 1 bit* 8 bit Minimum Scan Resolution 75 dpi 150 dpi 200 dpi 300 dpi*	Configure the auto color detection setting.
<b>JPEG Quality</b> Best for content* 5–95	Set the JPEG quality of the scanned image.
<b>Note:</b> An asterisk (*) next to a value indicates the factory default setting.	

Menu item	Description
<b>Contrast</b> Best for content* 0–5	Specify the contrast for the scanned image.
<b>Background Removal</b> Background Detection Content-based* Fixed Level -4 to 4 (0*)	Remove the background color or image noise from the original document.  <b>Notes:</b> <ul style="list-style-type: none"> <li>• Content-based removes the background color from the original document.</li> <li>• Fixed removes image noise from a photo.</li> </ul>
<b>Mirror Image</b> Off* On	Create a mirror image of the original document.
<b>Negative Image</b> Off* On	Create a negative image of the original document.
<b>Shadow Detail</b> -4 to 4 (0*)	Adjust the shadow detail in the scanned image.
<b>Scan Edge to Edge</b> Off* On	Scan the original document from edge to edge.
<b>Sharpness</b> 1–5 (3*)	Adjust the sharpness in the scanned image.
<b>Temperature</b> -4 to 4 (0*)	Generate a bluer or redder output of the original document.
<b>Blank Pages</b> Blank Page Removal (Do Not Remove*) Blank Page Sensitivity (5*)	Set the sensitivity of scans in relation to blank pages in the original document.
<b>Note:</b> An asterisk (*) next to a value indicates the factory default setting.	

**Admin Controls**

Menu item	Description
<b>Max E-mail Size</b> 0–65535 (0*)	Set the allowable file size for each e-mail.
<b>Size Error Message</b>	Specify an error message that the printer sends when an e-mail exceeds its allowable file size.  <b>Note:</b> You can type up to 1024 characters.
<b>Limit Destinations</b>	Limit sending of e-mail only to the specified list of domain name.  <b>Note:</b> Use a comma to separate each domain.
<b>Note:</b> An asterisk (*) next to a value indicates the factory default setting.	

Menu item	Description
<b>Send Me a Copy</b> Never appears* On by Default Off by Default Always On	Send a copy of the e-mail to yourself.
<b>Allow self e-mails only</b> Off* On	Set the printer to send e-mails to yourself only.
<b>Use cc:/bcc:</b> Off* On	Enable carbon copy and blind carbon copy in e-mail.
<b>Use Multi-Page TIFF</b> Off On*	Enable scanning of multiple TIFF images in one TIFF file.
<b>TIFF Compression</b> JPEG LZW*	Specify the compression type for TIFF files.
<b>Text Default</b> 5–95 (75*)	Set the text quality in the content being scanned.
<b>Text/Photo Default</b> 5–95 (75*)	Set the text and photo quality in the content being scanned.
<b>Photo Default</b> 5–95 (50*)	Set the photo quality of the content being scanned.
<b>Adjust ADF Skew</b> Off* On	Set the printer to adjust the skewed images from documents that are scanned from the ADF.
<b>Transmission Log</b> Print log* Do Not Print Log Print Only For Error	Print a transmission log for e-mail scans.
<b>Log Paper Source</b> Tray [x] (1*) Multipurpose Feeder	Specify the paper source for printing e-mail logs.
<b>Custom Job Scanning</b> Off* On	Set the printer to scan the first set of original documents using the specified settings, and then next set with the same or different settings. <b>Note:</b> This menu item appears only when a hard disk is installed.
<b>Scan Preview</b> Off On*	Show a scan preview of the original document. <b>Note:</b> This menu item appears only when a hard disk is installed.
<b>Note:</b> An asterisk (*) next to a value indicates the factory default setting.	

Menu item	Description
<b>Allow Save as Shortcut</b> Off On*	Save an e-mail address as a shortcut.
<b>E-mail Images Sent As</b> Attachment* Web Link	Specify how to send the images that are included in the e-mail.
<b>Reset E-mail Information After Sending</b> Off On*	Reset the To, Subject, Message, and Filename fields to their default values after sending an e-mail.
<b>Note:</b> An asterisk (*) next to a value indicates the factory default setting.	

## Web Link Setup

Menu item	Description
<b>Server</b>	Specify the credentials of the server that is hosting the images that are included in the e-mail.
<b>Login</b>	
<b>Password</b>	
<b>Path</b>	
<b>File Name</b>	
<b>Web Link</b>	

## FTP

### FTP Defaults

Menu item	Description
<b>Format</b> JPEG (.jpg) PDF (.pdf)* TIFF (.tif) XPS (.xps) TXT (.txt) RTF (.rtf) DOCX (.docx) CSV (.csv)	Specify the file format for the scanned image.  <b>Note:</b> The menu items may vary depending on your printer model.
<b>Note:</b> An asterisk (*) next to a value indicates the factory default setting.	



Menu item	Description
<b>Global OCR Settings</b> Recognized Languages Auto Rotate Despeckle Auto Contrast Enhance	Configure the settings for optical character recognition (OCR). <b>Note:</b> This menu item appears only if you have purchased and installed an OCR solution.
<b>PDF Settings</b> PDF Version (1.5*) Archival Version (A-1a*) Highly Compressed (Off*) Secure (Off*) Archival (PDF/A) (Off*)	Configure the PDF settings for the scanned image. <b>Notes:</b> <ul style="list-style-type: none"> <li>• Archival Version and Archival (PDF/A) are supported only when PDF Version is set to 1.4.</li> <li>• Highly Compressed appears only when a hard disk is installed.</li> </ul>
<b>Content Type</b> Text Text/Photo* Photo Graphics	Improve the output result based on the content type of the original document.
<b>Content Source</b> Black and White Laser* Color Laser Inkjet Photo/Film Magazine Newspaper Press Other	Improve the output result based on the content source of the original document.
<b>Color</b> Black and White Gray Color* Auto	Set the printer to capture file content in color or in mono.
<b>Resolution</b> 75 dpi 150 dpi* 200 dpi 300 dpi 400 dpi 600 dpi	Set the resolution of the scanned image.
<b>Darkness</b> 1–9 (5*)	Adjust the darkness of the scanned image.
<b>Orientation</b> Portrait* Landscape	Specify the orientation of the original document.
<b>Note:</b> An asterisk (*) next to a value indicates the factory default setting.	

Menu item	Description
<b>Original Size</b> Mixed Sizes*	Set the paper size of the original document.
<b>Sides</b> Off* Long Edge Short Edge	Specify the orientation when scanning on both sides of the document.
<b>File Name</b>	Specify the file name of the scanned image.
<b>Note:</b> An asterisk (*) next to a value indicates the factory default setting.	

### Advanced Imaging

Menu item	Description
<b>Color Balance</b> Cyan (0*) Magenta (0*) Yellow (0*)	Adjust the color intensity for cyan, magenta, and yellow.
<b>Color Dropout</b> Color Dropout None* Red* Green* Blue* Default Red Threshold 0–255 (128*) Default Green Threshold 0–255 (128*) Default Blue Threshold 0–255 (128*)	Specify which color to drop during scanning, and adjust the dropout setting for that color.
<b>Auto Color Detect</b> Color Sensitivity 1–9 (5*) Area Sensitivity 1–9 (5*) FTP Bit Depth 1 bit* 8 bit Minimum Scan Resolution 75 dpi 150 dpi 200 dpi 300 dpi*	Configure the auto color detection setting.
<b>Note:</b> An asterisk (*) next to a value indicates the factory default setting.	

Menu item	Description
<b>JPEG Quality</b> Best for content* 5–95	Set the JPEG quality of the scanned image.
<b>Contrast</b> Best for content* 0 1 2 3 4 5	Specify the contrast for the scanned image.
<b>Background Removal</b> Background Detection Content-based* Fixed Level -4 to 4 (0*)	Remove the background color or image noise from the original document.  <b>Notes:</b> <ul style="list-style-type: none"> <li>• Content-based removes the background color from the original document .</li> <li>• Fixed removes image noise from a photo.</li> </ul>
<b>Mirror Image</b> Off* On	Create a mirror image of the original document.
<b>Negative Image</b> Off* On	Create a negative image of the original document.
<b>Shadow Detail</b> -4 to 4 (0*)	Adjust the shadow detail in the scanned image.
<b>Scan Edge to Edge</b> Off* On	Allow edge-to-edge scanning of the original document.
<b>Sharpness</b> 1–5 (3*)	Adjust the sharpness in the scanned image.
<b>Temperature</b> -4 to 4 (0*)	Generate a bluer or redder output of the original document.
<b>Blank Pages</b> Blank Page Removal Do Not Remove* Remove Blank Page Sensitivity 1–9 (5*)	Set the sensitivity of scans in relation to blank pages in the original document.
<b>Note:</b> An asterisk (*) next to a value indicates the factory default setting.	

**Admin Controls**

Menu item	Description
<b>Text Default</b> 5–95 (75*)	Set the quality of text on the scanned image.
<b>Text/Photo Default</b> 5–95 (75*)	Set the quality of text and photo on the scanned image.
<b>Photo Default</b> 5–95 (50*)	Set the quality of photo on the scanned image.
<b>Use Multi-Page TIFF</b> On* Off	Enable scanning of multiple TIFF images in one TIFF file.
<b>TIFF Compression</b> LZW* JPEG	Specify the compression type for TIFF files.
<b>Transmission Log</b> Print Log* Do Not Print Log Print Only For Error	Print a transmission log for FTP scans.
<b>Log Paper Source</b> Tray [x] (1*) Multipurpose Feeder	Specify the paper source for printing FTP logs.
<b>Log Output Bin</b> Standard Bin* Bin [x]	Specify the output bin for printed FTP logs.
<b>Custom Job Scanning</b> Off* On	Turn on scanning of custom jobs by default. <b>Note:</b> This menu item appears only when a hard disk is installed.
<b>Scan Preview</b> Off On*	Show a preview of the scan on the display. <b>Note:</b> This menu item appears only when a hard disk is installed.
<b>Allow Save as Shortcut</b> Off On*	Save an FTP address as a shortcut.
<b>Adjust ADF Skew</b> Off* On	Set the printer to adjust the skewed images from documents that are scanned from the ADF.
<b>Note:</b> An asterisk (*) next to a value indicates the factory default setting.	

## USB Drive

### Flash Drive Scan

Menu item	Description
<b>Format</b> JPEG (.jpg) PDF (.pdf)* TIFF (.tif) XPS (.xps) TXT (.txt) RTF (.rtf) DOCX (.docx) CSV (.csv)	Specify the file format for the scanned image. <b>Note:</b> The menu items may vary depending on your printer model.
<b>Global OCR Settings</b> Recognized Languages Auto Rotate Despeckle Auto Contrast Enhance	Configure the settings for optical character recognition (OCR). <b>Note:</b> This menu item appears only if you have purchased and installed an OCR solution.
<b>PDF Settings</b> PDF Version (1.5*) Archival Version (A-1a*) Highly Compressed (Off*) Secure (Off*) Archival (PDF/A) (Off*)	Configure the PDF settings of the scanned image. <b>Notes:</b> <ul style="list-style-type: none"> <li>Archival Version and Archival (PDF/A) are supported only when PDF Version is set to 1.4.</li> <li>Highly Compressed appears only when a hard disk is installed.</li> </ul>
<b>Content Type</b> Text Text/Photo* Photo Graphics	Improve the output result based on the content type of the original document.
<b>Content Source</b> Black and White Laser* Color Laser Inkjet Photo/Film Magazine Newspaper Press Other	Improve the output result based on the content source of the original document.
<b>Note:</b> An asterisk (*) next to a value indicates the factory default setting.	

Menu item	Description
<b>Color</b> Black and White Gray Color* Auto	Set the printer to capture file content in color or in mono.
<b>Resolution</b> 75 dpi 150 dpi* 200 dpi 300 dpi 400 dpi 600 dpi	Set the resolution of the scanned image.
<b>Darkness</b> 1–9 (5*)	Adjust the darkness of the scanned image.
<b>Orientation</b> Portrait* Landscape	Specify the orientation of the original document.
<b>Original Size</b> Mixed Sizes*	Set the paper size of the original document.
<b>Sides</b> Off* Long edge Short edge	Specify the orientation of the original document when scanning on both sides of the document.
<b>File Name</b>	Specify the file name of the scanned image.
<b>Note:</b> An asterisk (*) next to a value indicates the factory default setting.	

### Advanced Imaging

Menu item	Description
<b>Color Balance</b> Cyan (0*) Magenta (0*) Yellow (0*)	Adjust the color intensity for cyan, magenta, and yellow.
<b>Note:</b> An asterisk (*) next to a value indicates the factory default setting.	

Menu item	Description
<b>Color Dropout</b> Color Dropout None* Red Green Blue Default Red Threshold 0–255 (128*) Default Green Threshold 0–255 (128*) Default Blue Threshold 0–255 (128*)	Specify which color to drop during scanning, and adjust the dropout setting for that color.
<b>Auto Color Detect</b> Color Sensitivity 1–9 (5*) Area Sensitivity 1–9 (5*) Scan Bit Depth 1 bit* 8 bit Minimum Scan Resolution 75 dpi 150 dpi 200 dpi 300 dpi*	Configure the auto color detection setting.
<b>JPEG Quality</b> Best for content* 5–95	Set the JPEG quality of the scanned image.
<b>Contrast</b> Best for content* 0–5	Specify the contrast for the scanned image.
<b>Background Removal</b> Background Detection Content-based* Fixed Level (0*)	Remove the background color or image noise from the original document. <b>Notes:</b> <ul style="list-style-type: none"> <li>• Content-based removes the background color from the original document.</li> <li>• Fixed removes image noise from a photo.</li> </ul>
<b>Mirror Image</b> Off* On	Create a mirror image of the original document.
<b>Negative Image</b> Off* On	Create a negative image of the original document.
<b>Note:</b> An asterisk (*) next to a value indicates the factory default setting.	

Menu item	Description
<b>Shadow Detail</b> -4 to 4 (0*)	Adjust the shadow detail in the scanned image.
<b>Scan Edge to Edge</b> Off* On	Scan the original document from edge to edge.
<b>Sharpness</b> 1–5 (3*)	Adjust the sharpness in the scanned image.
<b>Temperature</b> -4 to 4 (0*)	Generate a bluer or redder output of the original document.
<b>Blank Pages</b> Blank Page Removal Do Not Remove* Remove Blank Page Sensitivity 1–9 (5*)	Set the sensitivity of scans in relation to blank pages in the original document.
<b>Note:</b> An asterisk (*) next to a value indicates the factory default setting.	

**Admin Controls**

Menu item	Description
<b>Text Default</b> 5–95 (75*)	Set the quality of text on the scanned image.
<b>Text/Photo Default</b> 5–95 (75*)	Set the quality of text and photo on the scanned image.
<b>Photo Default</b> 5–95 (50*)	Set the quality of a photo on the scanned image.
<b>Use Multi-Page TIFF</b> Off On*	Enable scanning of multiple TIFF images in one TIFF file.
<b>TIFF Compression</b> LZW* JPEG	Specify the compression type for TIFF files.
<b>Custom Job Scanning</b> Off* On	Turn on scanning of custom jobs by default. <b>Note:</b> This menu item appears only when a hard disk is installed.
<b>Scan Preview</b> Off On*	Show a preview of the scan on the display. <b>Note:</b> This menu item appears only when a hard disk is installed.
<b>Note:</b> An asterisk (*) next to a value indicates the factory default setting.	



Menu item	Description
<b>Adjust ADF Skew</b> Off* On	Set the printer to adjust the skewed images from documents that are scanned from the ADF.
<b>Note:</b> An asterisk (*) next to a value indicates the factory default setting.	

## Flash Drive Print

Menu item	Description
<b>Number of Copies</b> 1–9999 (1*)	Set the number of copies.
<b>Paper Source</b> Tray [x] (1*) Multipurpose Feeder Manual Paper Manual Envelope	Set the paper source for the print job.
<b>Collate</b> (1,1) (2,2,2) (1,2,3) (1,2,3)*	Keep the pages of a print job stacked in sequence, particularly when printing multiple copies of the job.
<b>Sides</b> 1-Sided* 2-Sided	Specify whether to print on one side or both sides of the paper.
<b>Staple</b> Off* 1 staple, top left corner 2 staples, left 1 staple, top right corner 2 staples, top 1 staple, bottom left corner 2 staples, bottom 1 staple, bottom right corner 2 staples, right	Specify the staple position for all print jobs. <b>Note:</b> This menu item appears only when a staple finisher is installed.
<b>Hole Punch</b> Off* 2 holes 3 holes	Set the punch mode for all print jobs. <b>Note:</b> This menu item appears only when a staple finisher is installed.
<b>Note:</b> An asterisk (*) next to a value indicates the factory default setting.	

Menu item	Description
<b>Offset Pages</b> None* Between Copies Between Jobs	Offset the output of each print job or each copy of a print job. <b>Notes:</b> <ul style="list-style-type: none"> <li>• Between Copies offsets each copy of a print job if Collate is set to On [1,2,1,2,1,2]. If Collate is set to Off [1,1,2,2,2,2], then each set of printed pages are offset, such as all page 1s and all page 2s.</li> <li>• Between Jobs sets the same offset position for the entire print job regardless of the number of copies printed.</li> <li>• This menu item appears only when a staple finisher is installed.</li> </ul>
<b>Flip Style</b> Long Edge* Short Edge	Determine which side of the paper is bound when performing two-sided printing.
<b>Pages per Side</b> Off* 2 pages per side 3 pages per side 4 pages per side 6 pages per side 9 pages per side 12 pages per side 16 pages per side	Print multiple page images on one side of a sheet of paper.
<b>Pages per Side Ordering</b> Horizontal* Reverse Horizontal Reverse Vertical Vertical	Specify the positioning of multiple page images when using Pages per Side menu.
<b>Pages per Side Orientation</b> Auto* Landscape Portrait	Specify the orientation of multiple page images when using Pages per Side menu.
<b>Pages per Side Border</b> None* Solid	Print a border around each page image when using Pages per Side menu.
<b>Separator Sheets</b> Off* Between Copies Between Jobs Between Pages	Insert blank separator sheets when printing.
<b>Separator Sheet Source</b> Tray [x] (1*) Multipurpose Feeder	Specify the paper source for the separator sheet.
<b>Note:</b> An asterisk (*) next to a value indicates the factory default setting.	

Menu item	Description
<b>Blank Pages</b> Do Not Print* Print	Print blank pages in a print job.
<b>Note:</b> An asterisk (*) next to a value indicates the factory default setting.	

## Network/Ports

### Network Overview

Menu item	Description
<b>Active Adapter</b> Auto* Standard Network Wireless	Specify the type of the network connection.  <b>Note:</b> Wireless is available only in printers connected to a wireless network.
<b>Network Status</b>	Show the connectivity status of the printer network.
<b>Display Network Status on Printer</b> Off On*	Show the network status on the display.
<b>Speed, Duplex</b>	Show the speed of the currently active network card.
<b>IPv4</b>	Show the IPv4 address.
<b>All IPv6 Addresses</b>	Show all IPv6 addresses.
<b>Reset Print Server</b>	Reset all active network connections to the printer.  <b>Note:</b> This setting removes all network configuration settings.
<b>Network Job Timeout</b> Off On* (90 seconds)	Set the time before the printer cancels a network print job.
<b>Banner Page</b> Off* On	Print a banner page.
<b>Scan to PC Port Range</b>	Specify a valid port range for printers that are behind a port blocking firewall.
<b>Enable Network Connections</b> Off On*	Enable the printer to connect to a network.
<b>Enable LLDP</b> Off* On	Enable Link Layer Discovery Protocol (LLDP) in the printer.
<b>Note:</b> An asterisk (*) next to a value indicates the factory default setting.	

## Wireless

**Note:** This menu is available only in printers connected to a Wi-Fi network or printers that have a wireless network adapter.

Menu item	Description
<b>Setup Using Mobile App</b>	Configure the Wi-Fi connection using Lexmark Mobile Assistant.
<b>Setup On Printer Panel</b> Choose Network Add Wi-Fi Network Network Name Network Mode Infrastructure Wireless Security Mode Disabled* WEP WPA2/WPA - Personal WPA2 - Personal 802.1x - RADIUS	Configure the Wi-Fi connection using the control panel.  <b>Note:</b> 802.1x - RADIUS can be configured only from the Embedded Web Server.
<b>Wi-Fi Protected Setup</b> WPS Auto Detect Off On* Start Push Button Method Start PIN Method	Establish a Wi-Fi network and enable network security.  <b>Notes:</b> <ul style="list-style-type: none"> <li>• WPS Auto Detect appears only when the Wireless Security Mode is set to WEP.</li> <li>• Start Push-Button Method connects the printer to a Wi-Fi network when buttons on both the printer and the access point (wireless router) are pressed within a given time.</li> <li>• Start PIN Method connects the printer to a Wi-Fi network when a PIN on the printer is entered into the wireless settings of the access point.</li> </ul>
<b>Network Mode</b> BSS Type Infrastructure*	Specify the network mode.
<b>Compatibility</b> 802.11b/g/n (2.4GHz)* 802.11a/b/g/n/ac (2.4GHz/5GHz) 802.11a/n/ac (5GHz)	Specify the standard for the Wi-Fi network.  <b>Note:</b> 802.11a/b/g/n/ac (2.4GHz/5GHz) and 802.11a/n/ac (5GHz) only appear when a Wi-Fi option is installed.
<b>Wireless Security Mode</b> Disabled* WEP WPA2/WPA-Personal WPA2-Personal 802.1x - RADIUS	Set the security mode for connecting the printer to Wi-Fi devices.  <b>Note:</b> 802.1x - RADIUS can be configured only from the Embedded Web Server.

Menu item	Description
<b>WEP Authentication Mode</b> Auto* Open Shared	Set the type of Wireless Encryption Protocol (WEP) for the printer. <b>Note:</b> This menu item appears only when the Wireless Security Mode is set to WEP.
<b>Set WEP Key</b>	Specify a WEP password for secure Wi-Fi connection.
<b>WPA2/WPA Personal</b> AES	Enable Wi-Fi security through Wi-Fi Protected Access (WPA). <b>Note:</b> This menu item appears only when the Wireless Security Mode is set to WPA2/WPA-Personal.
<b>Set Pre-Shared Key</b>	Set the password for secure Wi-Fi connection.
<b>WPA2-Personal</b> AES	Enable Wi-Fi security through WPA2. <b>Note:</b> This menu item appears only when the Wireless Security Mode is set to WPA2-Personal.
<b>802.1x Encryption Mode</b> WPA+ WPA2*	Enable Wi-Fi security through 802.1x standard. <b>Notes:</b> <ul style="list-style-type: none"> <li>• This menu item appears only when the Wireless Security Mode is set to 802.1x - RADIUS.</li> <li>• 802.1x - RADIUS can be configured only from the Embedded Web Server.</li> </ul>
<b>IPv4</b> Enable DHCP On* Off Set Static IP Address IP Address Netmask Gateway	Enable and configure IPv4 settings in the printer.
<b>IPv6</b> Enable IPv6 On* Off Enable DHCPv6 On Off* Stateless Address Autoconfiguration On* Off DNS Server Address Manually Assigned IPv6 Address Manually Assigned IPv6 Router Address Prefix All IPv6 Addresses All IPv6 Router Addresses	Enable and configure IPv6 settings in the printer.

Menu item	Description
<b>Network Address</b> UAA LAA	View the network addresses.
<b>PCL SmartSwitch</b> Off On*	Set the printer to switch automatically to PCL emulation when a print job requires it, regardless of the default printer language. <b>Note:</b> If PCL SmartSwitch is off, then the printer does not examine incoming data and uses the default printer language specified in the Setup menu.
<b>PS SmartSwitch</b> Off On*	Set the printer to switch automatically to PS emulation when a print job requires it, regardless of the default printer language. <b>Note:</b> If PS SmartSwitch is off, then the printer does not examine incoming data and uses the default printer language specified in the Setup menu.
<b>Job Buffering</b> On Off*	Temporarily store print jobs in the printer hard disk before printing. <b>Note:</b> This menu item appears only when a hard disk is installed.
<b>Mac Binary PS</b> Auto* On Off	Set the printer to process Macintosh binary PostScript print jobs. <b>Notes:</b> <ul style="list-style-type: none"> <li>• On processes raw binary PostScript print jobs.</li> <li>• Off filters print jobs using the standard protocol.</li> </ul>

## Wi-Fi Direct

Menu item	Description
<b>Enable Wi-Fi Direct</b> On Off*	Set the printer to connect directly to Wi-Fi devices.
<b>Wi-Fi Direct Name</b>	Specify the name of the Wi-Fi Direct network.
<b>Wi-Fi Direct Password</b>	Set the password to authenticate and validate users on a Wi-Fi connection.
<b>Show Password on Setup Page</b> Off On*	Show the Wi-Fi Direct Password on the Network Setup Page.
<b>Preferred Channel Number</b> 1–11 Auto*	Set the preferred channel of the Wi-Fi network.
<b>Group Owner IP Address</b>	Specify the IP address of the group owner.
<b>Auto-Accept Push Button Requests</b> Off* On	Accept requests to connect to the network automatically. <b>Note:</b> Accepting clients automatically is not secured.
<b>Note:</b> An asterisk (*) next to a value indicates the factory default setting.	

## Ethernet

Menu item	Description
<b>Network Speed</b>	Show the speed of the active network adapter.
<b>IPv4</b> Enable DHCP (On*) Set Static IP Address	Configure the IPv4 settings.
<b>IPv6</b> Enable IPv6 (On*) Enable DHCPv6 (Off*) Stateless Address Autoconfiguration (On*) DNS Server Address Manually Assigned IPv6 Address Manually Assigned IPv6 Router Address Prefix (64*) All IPv6 Addresses All IPv6 Router Addresses	Configure the IPv6 settings.
<b>Network Address</b> UAA LAA	Specify the network address.
<b>PCL SmartSwitch</b> Off On*	Set the printer to switch automatically to PCL emulation when a print job requires it, regardless of the default printer language. <b>Note:</b> When this setting is disabled, the printer does not examine incoming data and uses the default printer language specified in the Setup menu.
<b>PS SmartSwitch</b> Off On*	Set the printer to switch automatically to PostScript emulation when a print job requires it, regardless of the default printer language. <b>Note:</b> When this setting is disabled, the printer does not examine incoming data and uses the default printer language specified in the Setup menu.
<b>Job Buffering</b> Off* On	Temporarily store jobs on the hard disk before printing. <b>Note:</b> This menu item appears only when a hard disk is installed.
<b>Mac Binary PS</b> Auto* On Off	Set the printer to process Macintosh binary PostScript print jobs. <b>Notes:</b> <ul style="list-style-type: none"> <li>• Auto processes print jobs from computers using either Windows or Macintosh operating systems.</li> <li>• Off filters PostScript print jobs using the standard protocol.</li> </ul>
<b>Energy Efficient Ethernet</b> On Off Auto*	Reduce power consumption when the printer does not receive data from the Ethernet network.
<b>Note:</b> An asterisk (*) next to a value indicates the factory default setting.	

## TCP/IP

**Note:** This menu appears only in network printers or printers attached to print servers.

Menu item	Description
<b>Set Hostname</b>	Set the current TCP/IP host name.
<b>Domain Name</b>	Set the domain name.
<b>Allow DHCP/BOOTP to update NTP server</b> On* Off	Allow the DHCP and BOOTP clients to update the NTP settings of the printer.
<b>Zero Configuration Name</b>	Specify a service name for the zero configuration network.
<b>Enable Auto IP</b> Off* On	Assign an IP address automatically.
<b>DNS Server Address</b>	Specify the current Domain Name System (DNS) server address.
<b>Backup DNS Address</b>	Specify the backup DNS server addresses.
<b>Backup DNS Address 2</b>	
<b>Backup DNS Address 3</b>	
<b>Domain Search Order</b>	Specify a list of domain names to locate the printer and its resources that reside in different domains on the network.
<b>Enable DDNS</b> Off* On	Update the Dynamic DNS settings.
<b>DDNS TTL</b>	Specify the current DDNS settings.
<b>Default TTL</b>	
<b>DDNS Refresh Time</b>	
<b>Enable mDNS</b> Off On*	Update the multicast DNS settings.
<b>WINS Server Address</b>	Specify a server address for Windows Internet Name Service (WINS).
<b>Enable BOOTP</b> Off* On	Allow the BOOTP to assign a printer IP address.
<b>Restricted Server List</b>	Specify the IP addresses that are allowed to communicate with the printer over TCP/IP.  <b>Notes:</b> <ul style="list-style-type: none"> <li>• Use a comma to separate each IP address.</li> <li>• You can add up to 50 IP addresses.</li> </ul>
<b>Note:</b> An asterisk (*) next to a value indicates the factory default setting.	



Menu item	Description
<b>Restricted Server List Options</b> Block All Ports* Block Printing Only Block Printing and HTTP Only	Specify the access option for IP addresses that are not in the list.
<b>MTU</b> 256–1500 Ethernet (1500*)	Specify a maximum transmission unit (MTU) parameter for the TCP connections.
<b>Raw Print Port</b> 1–65535 (9100*)	Specify a raw port number for printers connected on a network.
<b>Outbound Traffic Maximum Speed</b> Off* On	Set the maximum transfer rate of the printer. <b>Note:</b> When enabled, the option for this setting is 100–1000000 Kilobits/second.
<b>Enable TLSv1.0</b> Off On*	Enable the TLSv1.0 protocol.
<b>Enable TLSv1.1</b> Off On*	Enable the TLSv1.1 protocol.
<b>SSL Cipher List</b>	Specify the cipher algorithms to use for the SSL or the TLS connections.
<b>Note:</b> An asterisk (*) next to a value indicates the factory default setting.	

## SNMP

**Note:** This menu appears only in network printers or printers that are attached to print servers.

Menu item	Description
<b>SNMP Versions 1 and 2c</b> Enabled Off On* Allow SNMP Set Off On* Enable PPM MIB Off On* SNMP Community	Configure Simple Network Management Protocol (SNMP) versions 1 and 2c to install print drivers and applications.
<b>Note:</b> An asterisk (*) next to a value indicates the factory default setting.	

Menu item	Description
<b>SNMP Version 3</b> Enabled Off On* Context Name Set Read/Write Credentials User Name Authentication Password Privacy Password Set Read-only Credentials User Name Authentication Password Privacy Password Authentication Hash MD5 SHA1* Minimum Authentication Level No Authentication, No Privacy Authentication, No Privacy Authentication, Privacy* Privacy Algorithm DES AES-128*	Configure SNMP version 3 to install and update the printer security.
<b>Note:</b> An asterisk (*) next to a value indicates the factory default setting.	

## IPSec

**Note:** This menu appears only in network printers or printers that are attached to print servers.

Menu item	Description
<b>Enable IPSec</b> Off On*	Enable Internet Protocol Security (IPSec).
<b>Base Configuration</b> Default* Compatibility Secure	Set the IPSec base configuration.
<b>DH (Diffie-Hellman) Group Proposal</b> modp2048 (14)* modp3072 (15) modp4096 (16) modp6144 (17)	Set the IPSec base configuration. <b>Note:</b> This menu item appears only when Base Configuration is set to Compatibility.
<b>Note:</b> An asterisk (*) next to a value indicates the factory default setting.	

Menu item	Description
<b>Proposed Encryption Method</b> 3DES AES*	Set the encryption method. <b>Note:</b> This menu item appears only when Base Configuration is set to Compatibility.
<b>Proposed Authentication Method</b> SHA1 SHA256* SHA512	Set the authentication method. <b>Note:</b> This menu item appears only when Base Configuration is set to Compatibility.
<b>IKE SA Lifetime (Hours)</b> 1 2 4 8 24*	Specify the IKE SA expiry period. <b>Note:</b> This menu item appears only when Base Configuration is set to Secure.
<b>IPSec SA Lifetime (Hours)</b> 1 2 4 8* 24	Specify the IPSec SA expiry period. <b>Note:</b> This menu item appears only when Base Configuration is set to Secure.
<b>IPSec Device Certificate</b>	Specify an IPSec certificate.
<b>Pre-Shared Key Authenticated Connections</b> Host [x]	Configure the authenticated connections of the printer.
<b>Certificate Authenticated Connections</b> Host [x] Address[/subnet]	
<b>Note:</b> An asterisk (*) next to a value indicates the factory default setting.	

## 802.1x

**Note:** This menu appears only in network printers or printers that are attached to print servers.

Menu item	Description
<b>Active</b> Off* On	Let the printer join networks that require authentication before allowing access.
<b>Note:</b> An asterisk (*) next to a value indicates the factory default setting.	

## LPD Configuration

**Note:** This menu appears only in network printers or printers that are attached to print servers.

Menu item	Description
<b>LPD Timeout</b> 0–65535 seconds (90*)	Set the time-out value to stop the Line Printer Daemon (LPD) server from waiting indefinitely for hung or invalid print jobs.
<b>LPD Banner Page</b> Off* On	Print a banner page for all LPD print jobs. <b>Note:</b> A banner page is the first page of a print job used as a separator of print jobs and to identify the originator of the print job request.
<b>LPD Trailer Page</b> Off* On	Print a trailer page for all LPD print jobs. <b>Note:</b> A trailer page is the last page of a print job.
<b>LPD Carriage Return Conversion</b> Off* On	Enable carriage return conversion. <b>Note:</b> Carriage return is a mechanism that commands the printer to move the position of the cursor to the first position on the same line.
<b>Note:</b> An asterisk (*) next to a value indicates the factory default setting.	

## HTTP/FTP Settings

Menu item	Description
<b>Enable HTTP Server</b> Off On*	Access the Embedded Web Server to monitor and manage the printer.
<b>Enable HTTPS</b> Off On*	Enable Hypertext Transfer Protocol Secure (HTTPS) to encrypt data transferring to and from the print server.
<b>Force HTTPS Connections</b> On Off*	Force the printer to use HTTPS connections.
<b>Enable FTP/TFTP</b> Off On*	Send files using FTP/TFTP.
<b>Local Domains</b>	Specify domain names for HTTP and FTP servers.
<b>HTTP Proxy IP Address</b>	Configure the HTTP and FTP server settings.
<b>FTP Proxy IP Address</b>	
<b>HTTP Default IP Port</b>	
<b>HTTPS Device Certificate</b>	
<b>FTP Default IP Port</b>	
<b>Timeout for HTTP/FTP Requests</b> 1–299 (30*)	Specify the amount of time before the server connection stops.
<b>Note:</b> An asterisk (*) next to a value indicates the factory default setting.	

Menu item	Description
<b>Retries for HTTP/FTP Requests</b> 1–299 (3*)	Set the number of retries to connect to the HTTP/FTP server.
<b>Note:</b> An asterisk (*) next to a value indicates the factory default setting.	

## ThinPrint

Menu item	Description
<b>Enable ThinPrint</b> Off* On	Print using ThinPrint.
<b>Port Number</b> 4000–4999 (4000*)	Set the port number for the ThinPrint server.
<b>Bandwidth (bits/sec)</b> 100–1000000 (0*)	Set the speed to transmit data in a ThinPrint environment.
<b>Packet Size (kbytes)</b> 0–64000 (0*)	Set the packet size for data transmission.
<b>Note:</b> An asterisk (*) next to a value indicates the factory default setting.	

## USB

Menu item	Description
<b>PCL SmartSwitch</b> Off On*	Set the printer to switch to PCL emulation when a print job received through a USB port requires it, regardless of the default printer language. <b>Note:</b> When this setting is disabled, the printer does not examine incoming data and uses the default printer language specified in the Setup menu.
<b>PS SmartSwitch</b> Off On*	Set the printer to switch to PostScript emulation when a print job received through a USB port requires it, regardless of the default printer language. <b>Note:</b> When this setting is disabled, the printer does not examine incoming data and uses the default printer language specified in the Setup menu.
<b>Job Buffering</b> Off* On	Temporarily store jobs on the hard disk before printing. <b>Note:</b> This menu item appears only when a hard disk is installed.
<b>Mac Binary PS</b> Auto* On Off	Set the printer to process Macintosh binary PostScript print jobs. <b>Notes:</b> <ul style="list-style-type: none"> <li>• Auto processes print jobs from computers using either Windows or Macintosh operating systems.</li> <li>• Off filters PostScript print jobs using the standard protocol.</li> </ul>
<b>Note:</b> An asterisk (*) next to a value indicates the factory default setting.	

Menu item	Description
<b>Enable USB Port</b> Off On*	Enable the front USB drive port.
<b>Note:</b> An asterisk (*) next to a value indicates the factory default setting.	

## Restrict external network access

Menu item	Description
<b>Restrict external network access</b> Off* On	Restrict access to network sites.
<b>External network address</b>	Specify the network addresses with restricted access.
<b>E-mail address for notification</b>	Specify an e-mail address to send a notification of logged events.
<b>Ping frequency</b> 1–300 (10*)	Specify the network query interval in seconds.
<b>Subject</b>	Specify the subject and message of the notification e-mail.
<b>Message</b>	
<b>Note:</b> An asterisk (*) next to a value indicates the factory default setting.	

# Security

## Login Methods

### Manage Permissions

Menu item	Description
<p><b>Function Access</b></p> <ul style="list-style-type: none"> <li>Access Address Book in Apps</li> <li>Modify Address Book</li> <li>Manage Shortcuts</li> <li>Create Profiles</li> <li>Manage Bookmarks</li> <li>Flash Drive Print</li> <li>Flash Drive Scan</li> <li>Copy Function</li> <li>Color Dropout</li> <li>E-mail Function</li> <li>Fax Function</li> <li>FTP Function</li> <li>Release Held Faxes</li> <li>Held Jobs Access</li> <li>User Profiles</li> <li>Cancel Jobs at the Device</li> <li>Change Language</li> <li>Internet Printing Protocol (IPP)</li> <li>Initiate Scans Remotely</li> <li>B/W Print</li> <li>Network Folder - Scan</li> </ul>	<p>Control access to the printer functions.</p>
<p><b>Administrative Menus</b></p> <ul style="list-style-type: none"> <li>Security Menu</li> <li>Network/Ports Menu</li> <li>Paper Menu</li> <li>Reports Menu</li> <li>Function Configuration Menus</li> <li>Supplies Menu</li> <li>Option Card Menu</li> <li>SE Menu</li> <li>Device Menu</li> </ul>	<p>Control access to the printer menu settings.</p>

Menu item	Description
<b>Device Management</b> Remote Management Firmware Updates Apps Configuration Operator Panel Lock Import/Export All Settings Out of Service Erase Embedded Web Server Access	Control access to the printer management options.
<b>Apps</b> New Apps Slideshow Change Wallpaper Screen Saver Card Copy Scan Center Scan Center Custom 1 Scan Center Custom 2 Scan Center Custom 3 Scan Center Custom 4 Scan Center Custom 5 Scan Center Custom 6 Scan Center Custom 7 Scan Center Custom 8 Scan Center Custom 9 Scan Center Custom 10 Forms and Favorites	Control access to printer applications.

## Local Accounts

Menu item	Description
<b>Manage Groups/Permissions</b>	Show a list of all saved groups in the printer.
<b>Add User</b> User Name/Password User Name Password PIN	Create local accounts and specify their access to the printer functions, administrative menus, printer management options, and applications.

## Schedule USB Devices

Menu item	Description
<b>Schedules</b> Add New Schedule	Schedule access to the front USB port.



## Security Audit Log

Menu item	Description
<b>Enable Audit</b> Off* On	Record the events in the secure audit log and remote syslog.
<b>Enable Remote Syslog</b> Off* On	Send audit logs to a remote server.
<b>Remote Syslog Server</b>	Specify the remote syslog server.
<b>Remote Syslog Port</b> 1–65535 (514*)	Specify the remote syslog port.
<b>Remote Syslog Method</b> Normal UDP* Stunnel	Specify a syslog method to transmit logged events to a remote server.
<b>Remote Syslog Facility</b> 0 - Kernel Messages 1 - User-Level Messages 2 - Mail System 3 - System Daemons 4 - Security/Authorization Messages* 5 - Messages Generated Internally by Syslogs 6 - Line Printer Subsystem 7 - Network News Subsystem 8 - UUCP Subsystem 9 - Clock Daemon 10 - Security/Authorization Messages 11 - FTP Daemon 12 - NTP Subsystem 13 - Log Audit 14 - Log Alert 15 - Clock Daemon 16 - Local Use 0 (local0) 17 - Local Use 1 (local1) 18 - Local Use 2 (local2) 19 - Local Use 3 (local3) 20 - Local Use 4 (local4) 21 - Local Use 5 (local5) 22 - Local Use 6 (local6) 23 - Local Use 7 (local7)	Specify a facility code that the printer uses when sending log events to a remote server.
<b>Note:</b> An asterisk (*) next to a value indicates the factory default setting.	

Menu item	Description
<b>Severity of Events to Log</b> 0 - Emergency 1 - Alert 2 - Critical 3 - Error 4 - Warning* 5 - Notice 6 - Informational 7 - Debug	Specify the priority level cutoff for logging messages and events.
<b>Remote Syslog Non-Logged Events</b> Off* On	Send all events, regardless of severity level, to the remote server.
<b>Admin's E-mail Address</b>	Send e-mail notification of logged events to the administrator.
<b>E-mail Log Cleared Alert</b> Off* On	Send e-mail notification to the administrator when a log entry is deleted.
<b>E-mail Log Wrapped Alert</b> Off* On	Send e-mail notification to the administrator when the log becomes full and begins to overwrite the oldest entries.
<b>Log Full Behavior</b> Wrap Over Older Entries* E-mail Log Then Delete All Entries	Resolve log storage issues when the log fills its allotted memory.
<b>E-mail % Full Alert</b> Off* On	Send e-mail notification to the administrator when the log fills its allotted memory.
<b>% Full Alert Level</b> 1–99 (90*)	
<b>E-mail Log Exported Alert</b> Off* On	Send e-mail notification to the administrator when a log is exported.
<b>E-mail Log Settings Changed Alert</b> Off* On	Send e-mail notification to the administrator when Enable Audit is set.
<b>Log Line Endings</b> LF (\n)* CR (\r) CRLF (\r\n)	Specify how the log file terminates the end of each line.
<b>Note:</b> An asterisk (*) next to a value indicates the factory default setting.	

Menu item	Description
<b>Digitally Sign Exports</b> Off* On	Add a digital signature to each exported log file.
<b>Clear Log</b>	Delete all audit logs.
<b>Export Log</b> Syslog (RFC 5424) Syslog (RFC 3164) CSV	Export a security log to a flash drive.
<b>Note:</b> An asterisk (*) next to a value indicates the factory default setting.	

## Login Restrictions

Menu item	Description
<b>Login failures</b> 1–10 (3*)	Specify the number of failed login attempts before the user gets locked out.
<b>Failure time frame</b> 1–60 minutes (5*)	Specify the time frame between failed login attempts before the user gets locked out.
<b>Lockout time</b> 1–60 minutes (5*)	Specify the lockout duration.
<b>Web Login Timeout</b> 1–120 minutes (10*)	Specify the delay for a remote login before the user is logged off automatically.
<b>Note:</b> An asterisk (*) next to a value indicates the factory default setting.	

## Confidential Print Setup

Menu item	Description
<b>Max Invalid PIN</b> 2–10	Set the number of times an invalid PIN can be entered.  <b>Notes:</b> <ul style="list-style-type: none"> <li>• A value of zero turns off this setting.</li> <li>• When the limit is reached, the print jobs for that user name and PIN are deleted.</li> </ul>
<b>Confidential Job Expiration</b> Off* 1 Hour 4 Hours 24 Hours 1 Week	Set the expiration time for confidential print jobs.  <b>Notes:</b> <ul style="list-style-type: none"> <li>• If this menu item is changed while confidential print jobs reside in the printer memory or hard disk, then the expiration time for those print jobs does not change to the new default value.</li> <li>• If the printer is turned off, then all confidential jobs held in the printer memory are deleted.</li> </ul>
<b>Note:</b> An asterisk (*) next to a value indicates the factory default setting.	

Menu item	Description
<b>Repeat Job Expiration</b> Off* 1 Hour 4 Hours 24 Hours 1 Week	Set the expiration time for a print job that you want to repeat.
<b>Verify Job Expiration</b> Off* 1 Hour 4 Hours 24 Hours 1 Week	Set the expiration time that the printer prints a copy for the user to examine its quality, before printing the remaining copies.
<b>Reserve Job Expiration</b> Off* 1 Hour 4 Hours 24 Hours 1 Week	Set the expiration time that the printer stores print jobs for printing later.
<b>Require All Jobs to be Held</b> Off* On	Set the printer to hold all print jobs.
<b>Keep duplicate documents</b> Off* On	Set the printer to print other documents with the same file name without overwriting any of the print jobs.
<b>Note:</b> An asterisk (*) next to a value indicates the factory default setting.	

## Disk Encryption

**Note:** This menu appears only when a hard disk is installed.

Menu item	Description
<b>Status</b> Enabled Disabled	Enable disk encryption.
<b>Start encryption</b>	

## Erase Temporary Data Files

Menu item	Description
<b>Stored in onboard memory</b> Off* On	Delete all files stored on the printer memory.
<b>Stored on hard disk</b> 1 Pass Erase* 3 Pass Erase 7 Pass Erase	Delete all files stored on the printer hard disk.  <b>Note:</b> This menu item appears only when a printer hard disk is installed.
<b>Note:</b> An asterisk (*) next to a value indicates the factory default setting.	

## Solutions LDAP Settings

Menu item	Description
<b>Follow LDAP Referrals</b> Off* On	Search the different servers in the domain for the logged-in user account.
<b>LDAP Certificate Verification</b> Yes No*	Enable verification of LDAP certificates.

## Miscellaneous

Menu item	Description
<b>Protected Features</b> Show* Hide	Show all the features that Function Access Control (FAC) protects regardless of the security permission that the user has.  <b>Note:</b> Hide displays only FAC-protected features that the user has access.
<b>Print Permission</b> Off* On	Let the user log in before printing.
<b>Default Print Permission Login</b> User Name/Password* User Name	Set the default login for Print Permission.
<b>Security Reset Jumper</b> Enable "Guest" access* No Effect	Specify user access to the printer.  <b>Notes:</b> <ul style="list-style-type: none"> <li>The jumper is located beside a lock icon on the controller board.</li> <li>Enable "Guest" access provides anyone access to all aspects of the printer.</li> <li>No Effect may make access to the printer impossible when the required security information is unavailable.</li> </ul>
<b>Note:</b> An asterisk (*) next to a value indicates the factory default setting.	

Menu item	Description
<b>Minimum Password Length</b> 0–32	Specify the password length.
<b>Enable Password/PIN Reveal</b>	Show the password or personal identification number.
<b>Note:</b> An asterisk (*) next to a value indicates the factory default setting.	

## Reports

### Menu Settings Page

Menu item	Description
<b>Menu Settings Page</b>	Print a report that contains the printer menus.

### Device

Menu item	Description
<b>Device Information</b>	Print a report that contains information about the printer.
<b>Device Statistics</b>	Print a report about printer usage and supply status.
<b>Profile List</b>	Print a list of profiles that are stored in the printer.
<b>Asset Report</b>	Print a report that contains the printer serial number and model name.

### Print

Menu item	Description
<b>Print Fonts</b> PCL Fonts PS Fonts	Print samples and information about the fonts that are available in each printer language.
<b>Print Demo</b> Demo Page	Print a page that shows the printer capabilities and supported solutions.
<b>Print Directory</b>	Print the resources that are stored in the flash drive or printer hard disk. <b>Note:</b> This menu item appears only when a flash drive or printer hard disk is installed.

## Shortcuts

Menu item	Description
<b>All Shortcuts</b>	Print a report that lists the shortcuts that are stored in the printer.
<b>Fax Shortcuts</b>	
<b>Copy Shortcuts</b>	
<b>E-mail Shortcuts</b>	
<b>FTP Shortcuts</b>	
<b>Network Folder Shortcuts</b>	

## Fax

**Note:** This menu appears only if Fax is configured, and Enable Job Log is set to On.

Menu item	Description
<b>Fax Job Log</b>	Print a report about the last 200 completed fax jobs.
<b>Fax Call Log</b>	Print a report about the last 100 attempted, received, and blocked calls.

## Network

Menu item	Description
<b>Network Setup Page</b>	Print a page that shows the configured network and wireless settings on the printer. <b>Note:</b> This menu item appears only in network printers or printers connected to print servers.
<b>Wi-Fi Direct Connected Clients</b>	Print a page that shows the list of devices that are connected to the printer using Wi-Fi Direct. <b>Note:</b> This menu item appears only when Enable Wi-Fi Direct is set to On.

## Help

Menu item	Description
Print All Guides	Prints all the guides
Connection Guide	Provides information about connecting the printer locally (USB) or to a network
Copy Guide	Provides information about making copies and configuring the settings
E-mail Guide	Provides information about sending e-mails and configuring the settings
Fax Guide	Provides information about sending faxes and configuring the settings
FTP Guide	Provides information about scanning documents and configuring the settings
Information Guide	Provides more information sources about the printer

Menu item	Description
Media Guide	Provides information about loading paper and specialty media
Mono Quality Guide	Provides information about mono print quality settings
Moving Guide	Provides information about moving, locating, or shipping the printer
Print Quality Guide	Provides information about solving print quality issues
Supplies Guide	Provides information about ordering supplies

## Troubleshooting

Menu item	Description
<b>Print Quality Test Pages</b>	Print sample pages to identify and correct print quality defects.
<b>Cleaning the Scanner</b>	Print instructions on how to clean the scanner.

## Printing the Menu Settings Page

From the home screen, touch **Settings > Reports > Menu Settings Page**.



# Securing the printer

## Locating the security slot

The printer is equipped with a security lock feature. Attach a security lock compatible with most laptop computers in the location shown to secure the printer in place.



## Erasing printer memory

To erase volatile memory or buffered data in your printer, turn off the printer.

To erase nonvolatile memory or individual settings, device and network settings, security settings, and embedded solutions, do the following:

- 1 From the home screen, touch **Settings > Device > Maintenance > Out of Service Erase**.
- 2 Select the **Sanitize all information on nonvolatile memory** check box, and then touch **ERASE**.
- 3 Select **Start initial setup wizard** or **Leave printer offline**, and then touch **Next**.
- 4 Start the operation.

## Erasing printer hard disk memory

- 1 From the home screen, touch **Settings > Device > Maintenance > Out of Service Erase**.
- 2 Select the **Sanitize all information on hard disk** check box, and then touch **ERASE**.
- 3 Select a method to erase data.
- 4 Start the operation.

**Note:** This process can take from several minutes to more than an hour, making the printer unavailable for other tasks.

## Encrypting the printer hard disk

This process erases all contents in the hard disk. If necessary, back up important data from the printer before starting the encryption.

- 1 From the home screen, touch **Settings** > **Security** > **Disk Encryption** > **Start encryption**.
- 2 Follow the instructions on the display.

**Notes:**

- To avoid loss of data, do not turn off the printer during the encryption process.
- This process can take from several minutes to more than an hour, making the printer unavailable for other tasks.
- After encryption, the printer automatically restarts.

## Restoring factory default settings

- 1 From the home screen, touch **Settings** > **Device** > **Restore Factory Defaults**.
- 2 Touch **Restore Settings** > select the settings that you want to restore > **RESTORE**.
- 3 Start the operation.

## Statement of Volatility

Type of memory	Description
Volatile memory	The printer uses standard random access memory (RAM) to buffer temporarily user data during simple print and copy jobs.
Non-volatile memory	The printer may use two forms of non-volatile memory: EEPROM and NAND (flash memory). Both types are used to store the operating system, printer settings, network information, scanner and bookmark settings, and embedded solutions.
Hard disk memory	Some printers may have a hard disk drive installed. The printer hard disk is designed for printer-specific functionality. The hard disk lets the printer retain buffered user data from complex print jobs, form data, and font data.

Erase the content of any installed printer memory in the following circumstances:

- The printer is decommissioned.
- The printer hard disk is replaced.
- The printer is moved to a different department or location.
- The printer is serviced by someone from outside your organization.
- The printer is removed from your premises for service.
- The printer is sold to another organization.

### Disposing of a printer hard disk

- **Degaussing**—Flushes the hard disk with a magnetic field that erases stored data
- **Crushing**—Physically compresses the hard disk to break component parts and render them unreadable
- **Milling**—Physically shreds the hard disk into small metal bits

**Note:** To guarantee that all data are completely erased, destroy physically each hard disk where data is stored.

# Maintaining the printer

**Warning—Potential Damage:** Failure to maintain optimum printer performance, or to replace parts and supplies, may cause damage to your printer.

## Configuring supply notifications

- 1 Open a web browser, and then type the printer IP address in the address field.

**Notes:**

- View the printer IP address on the printer home screen. The IP address appears as four sets of numbers separated by periods, such as 123.123.123.123.
- If you are using a proxy server, then temporarily disable it to load the web page correctly.

- 2 Click **Settings > Device > Notifications**.
- 3 From the Supplies menu, click **Custom Supply Notifications**.
- 4 Select a notification for each supply item.
- 5 Apply the changes.

## Setting up e-mail alerts

Configure the printer to send e-mail alerts when supplies are low, when paper must be changed or added, or when there is a paper jam.

- 1 Open a web browser, and then type the printer IP address in the address field.

**Notes:**

- View the printer IP address on the printer home screen. The IP address appears as four sets of numbers separated by periods, such as 123.123.123.123.
- If you are using a proxy server, then temporarily disable it to load the web page correctly.

- 2 Click **Settings > Device > Notifications > E-mail Alert Setup**, and then configure the settings.  
**Note:** For more information on SMTP settings, contact your e-mail provider.
- 3 Click **Setup E-mail Lists and Alerts**, and then configure the settings.
- 4 Apply the changes.

## Viewing reports

- 1 From the home screen, touch **Settings > Reports**.
- 2 Select the report that you want to view.

## Adjusting the speaker volume

### Adjusting the default headphone volume

- 1 From the control panel, navigate to:

**Settings > Device > Accessibility**

- 2 Adjust the headphone volume.

**Note:** The volume resets to the default value after the session is logged out or when the printer wakes from Sleep or Hibernate mode.

### Configuring the fax speaker settings

**Note:** Make sure that fax is configured. For more information, see [“Setting up the printer to fax” on page 66](#).

- 1 From the home screen, touch **Settings > Fax > Fax Setup > Speaker Settings**.
- 2 Do the following:
  - Set Speaker Mode to **Always On**.
  - Set Speaker Volume to **High**.
  - Enable Ringer Volume.

## Networking

### Connecting the printer to a Wi-Fi network

Make sure that Active Adapter is set to Auto. From the home screen, touch **Settings > Network/Ports > Network Overview > Active Adapter**.

#### Using the control panel

- 1 From the home screen, touch **Settings > Network/Ports > Wireless > Setup On Printer Panel > Choose Network**.
- 2 Select a Wi-Fi network, and then type the network password.

**Note:** For Wi-Fi-network-ready printer models, a prompt for Wi-Fi network setup appears during initial setup.

#### Using Lexmark Mobile Assistant

- 1 Depending on your mobile device, download the Lexmark Mobile Assistant application from either the Google Play store or App Store online store.
- 2 From the printer home screen, touch **Settings > Network/Ports > Wireless > Setup Using Mobile App > Printer ID**.
- 3 From your mobile device, launch the application, and then accept the Terms of Use.

**Note:** If necessary, grant permissions.

- 4 Tap **Connect to Printer > Go to Wi-Fi Settings**.
- 5 Connect your mobile device to the printer wireless network.
- 6 Return to the application, and then tap **Setup Wi-Fi Connection**
- 7 Select a Wi-Fi network, and then type the network password.
- 8 Tap **Done**.

## Connecting the printer to a wireless network using Wi-Fi Protected Setup (WPS)

Before you begin, make sure that:

- The access point (wireless router) is WPS-certified or WPS-compatible. For more information, see the documentation that came with your access point.
- A wireless network adapter is installed in your printer. For more information, see the instructions that came with the adapter.
- Active Adapter is set to Auto. From the home screen, touch **Settings > Network/Ports > Network Overview > Active Adapter**.

### Using the Push Button method

- 1 From the home screen, touch **Settings > Network/Ports > Wireless > Wi-Fi Protected Setup > Start Push Button Method**.
- 2 Follow the instructions on the display.

### Using the personal identification number (PIN) method

- 1 From the home screen, touch **Settings > Network/Ports > Wireless > Wi-Fi Protected Setup > Start PIN Method**.
- 2 Copy the eight-digit WPS PIN.
- 3 Open a web browser, and then type the IP address of your access point in the address field.

#### Notes:

- To know the IP address, see the documentation that came with your access point.
  - If you are using a proxy server, then temporarily disable it to load the web page correctly.
- 4 Access the WPS settings. For more information, see the documentation that came with your access point.
  - 5 Enter the eight-digit PIN, and then save the changes.

## Configuring Wi-Fi Direct

Wi-Fi Direct® is a Wi-Fi-based peer-to-peer technology that allows wireless devices to connect directly to a Wi-Fi Direct-enabled printer without using an access point (wireless router).

**1** From the home screen, touch **Settings > Network/Ports > Wi-Fi Direct**.

**2** Configure the settings.

- **Enable Wi-Fi Direct**—Enables the printer to broadcast its own Wi-Fi Direct network.
- **Wi-Fi Direct Name**—Assigns a name for the Wi-Fi Direct network.
- **Wi-Fi Direct Password**—Assigns the password for negotiating the wireless security when using the peer-to-peer connection.
- **Show Password on Setup Page**—Shows the password on the Network Setup Page.
- **Auto-Accept Push Button Requests**—Lets the printer accept connection requests automatically.

**Note:** Accepting push-button requests automatically is not secured.

**Note:** To know the password of the Wi-Fi Direct network, print the Network Setup Page. From the home screen, touch **Settings > Reports > Network > Network Setup Page**.

## Connecting a mobile device to the printer

Before connecting your mobile device, make sure that Wi-Fi Direct has been configured. For more information, see [“Configuring Wi-Fi Direct” on page 171](#).

### Connecting using Wi-Fi Direct

**Note:** These instructions apply only to Android mobile devices.

- 1** From the mobile device, go to the settings menu.
- 2** Enable **Wi-Fi**, and then tap **Wi-Fi Direct**.
- 3** Select the printer Wi-Fi Direct name.
- 4** Confirm the connection on the printer control panel.

### Connecting using Wi-Fi

- 1** From the mobile device, go to the settings menu.
- 2** Tap **Wi-Fi**, and then select the printer Wi-Fi Direct name.

**Note:** The string DIRECT-xy (where x and y are two random characters) is added before the Wi-Fi Direct name.

- 3** Enter the Wi-Fi Direct password.

## Connecting a computer to the printer

Before connecting your computer, make sure to do the following:

- Enable Wi-Fi Direct in the printer. From the home screen, touch **Settings > Network/Ports > Wi-Fi Direct > Enable Wi-Fi Direct > On**.
- Take note of the Wi-Fi Direct name. From the home screen, touch **Settings > Network/Ports > Wi-Fi Direct > Wi-Fi Direct Name**.

- Take note of the Wi-Fi Direct password. From the home screen, touch **Settings > Network/Ports > Wi-Fi Direct > Wi-Fi Direct Password**.

**Note:** You can also configure the Wi-Fi Direct name and password.

### For Windows users

- 1 Open **Printers & scanners**, and then click **Add a printer or scanner**.
- 2 Click **Show Wi-Fi Direct printers**, and then select the printer Wi-Fi Direct name.
- 3 From the printer display, take note of the eight-digit PIN of the printer.
- 4 Enter the PIN on the computer.

**Note:** If the print driver is not already installed, then Windows downloads the appropriate driver.

### For Macintosh users

- 1 Click the wireless icon, and then select the printer Wi-Fi Direct name.

**Note:** The string DIRECT-xy (where x and y are two random characters) is added before the Wi-Fi Direct name.

- 2 Type the Wi-Fi Direct password.

**Note:** Switch your computer back to its previous network after disconnecting from the Wi-Fi Direct connection.

## Deactivating the Wi-Fi network

- 1 From the home screen, touch **Settings > Network/Ports > Network Overview > Active Adapter > Standard Network**.
- 2 Follow the instructions on the display.

## Changing the printer port settings after installing an internal solutions port

### Notes:

- If the printer has a static IP address, then do not change the configuration.
- If the computers are configured to use the network name instead of an IP address, then do not change the configuration.
- If you are adding a wireless internal solutions port (ISP) to a printer previously configured for an Ethernet connection, then disconnect the printer from the Ethernet network.

### For Windows users

- 1 Open the printers folder.
- 2 From the shortcut menu of the printer with the new ISP, open the printer properties.
- 3 Configure the port from the list.
- 4 Update the IP address.
- 5 Apply the changes.



### For Macintosh users

- 1 From System Preferences in the Apple menu, navigate to the list of printers, and then select + > IP.
- 2 Type the IP address in the address field.
- 3 Apply the changes.

## Setting up serial printing (Windows only)

- 1 Set the parameters in the printer.
  - a From the control panel, navigate to the menu for the port settings.
  - b Locate the menu for the serial port settings, and then adjust the settings, if necessary.
  - c Apply the changes.
- 2 From your computer, open the printers folder, and then select your printer.
- 3 Open the printer properties, and then select the COM port from the list.
- 4 Set the COM port parameters in Device Manager.

### Notes:

- Serial printing reduces printing speed.
- Make sure that the serial cable is connected to the serial port on your printer.

## Cleaning printer parts

### Cleaning the printer



**CAUTION—SHOCK HAZARD:** To avoid the risk of electrical shock when cleaning the exterior of the printer, unplug the power cord from the electrical outlet and disconnect all cables from the printer before proceeding.

### Notes:

- Perform this task after every few months.
  - Damage to the printer caused by improper handling is not covered by the printer warranty.
- 1 Turn off the printer, and then unplug the power cord from the electrical outlet.
  - 2 Remove paper from the standard bin and multipurpose feeder.
  - 3 Remove any dust, lint, and pieces of paper around the printer using a soft brush or vacuum.
  - 4 Wipe the outside of the printer with a damp, soft, lint-free cloth.

### Notes:

- Do not use household cleaners or detergents, as they may damage the finish of the printer.

- Make sure that all areas of the printer are dry after cleaning.

**5** Connect the power cord to the electrical outlet, and then turn on the printer.

**⚠ CAUTION—POTENTIAL INJURY:** To avoid the risk of fire or electrical shock, connect the power cord to an appropriately rated and properly grounded electrical outlet that is near the product and easily accessible.

## Cleaning the touch screen

**⚠ CAUTION—SHOCK HAZARD:** To avoid the risk of electric shock when cleaning the exterior of the printer, unplug the power cord from the electrical outlet and disconnect all cables from the printer before proceeding.

- 1** Turn off the printer, and then unplug the power cord from the electrical outlet.
- 2** Using a damp, soft, lint-free cloth, wipe the touch screen.

### Notes:

- Do not use household cleaners or detergents, as they may damage the touch screen.
- Make sure that the touch screen is dry after cleaning.

**3** Connect the power cord to the electrical outlet, and then turn on the printer.

**⚠ CAUTION—POTENTIAL INJURY:** To avoid the risk of fire or electrical shock, connect the power cord to an appropriately rated and properly grounded electrical outlet that is near the product and easily accessible.

## Cleaning the scanner

- 1** Open the scanner cover.



**2** Using a damp, soft, lint-free cloth, wipe the following areas:

- ADF glass

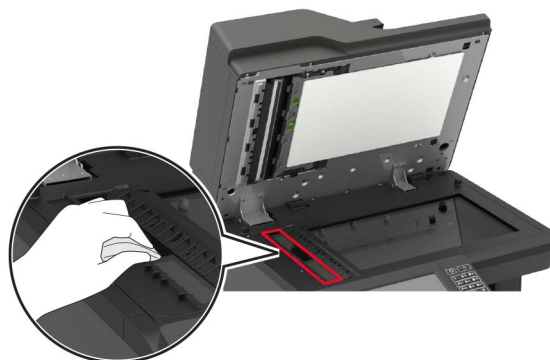

- ADF glass pad

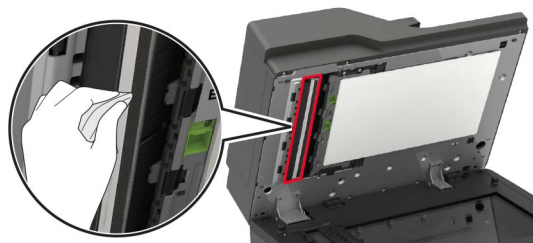

- Scanner glass



- Scanner glass pad

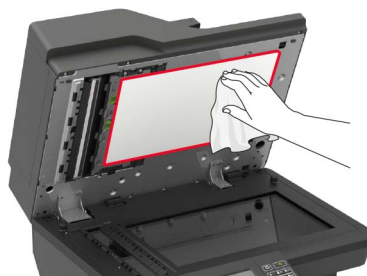

**3** Open door E.

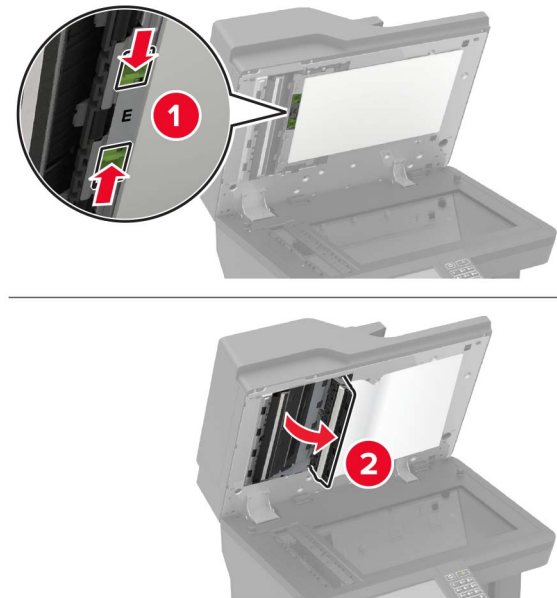

**4** Using a damp, soft, lint-free cloth, wipe the following areas:

- ADF glass pad in door E

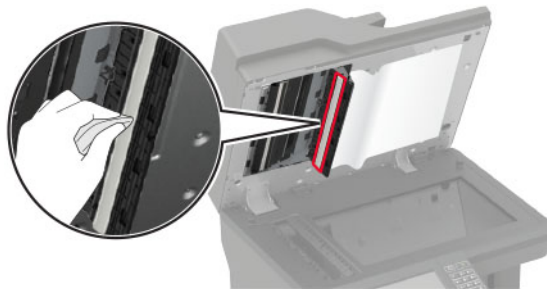

- ADF glass in door E

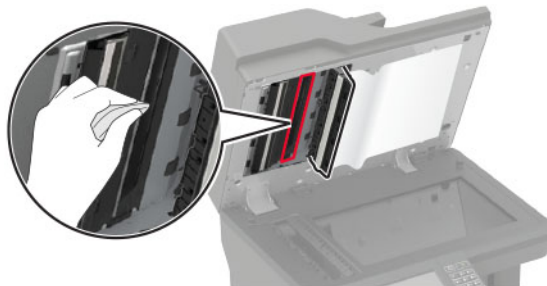

**5** Close door E, and then close the scanner cover.

## Cleaning the pick tires

- 1 Turn off the printer.
- 2 Remove the tray.

**Warning—Potential Damage:** To prevent damage from electrostatic discharge, touch any exposed metal frame of the printer before accessing or touching interior areas of the printer.



- 3 Remove the pick roller.

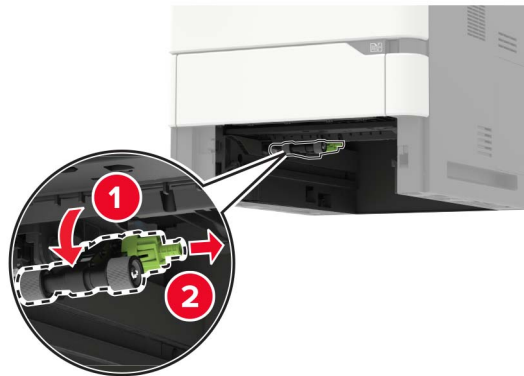

- 4 Using a damp, soft, lint-free cloth, wipe the pick tires.

**Note:** Apply isopropyl alcohol to the cloth.

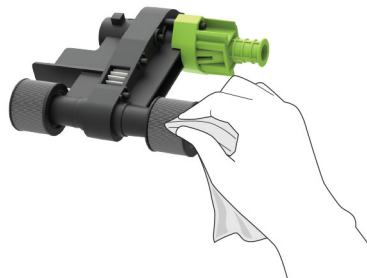

- 5 Insert the pick roller.

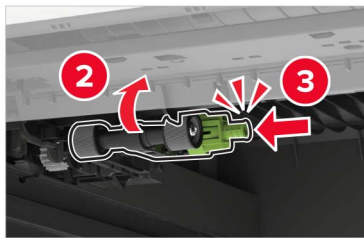

- 6 Insert the tray.

## Cleaning the pick roller in the multipurpose feeder

- 1 Turn off the printer.
- 2 Open the multipurpose feeder.

**Warning—Potential Damage:** To prevent damage from electrostatic discharge, touch any exposed metal frame of the printer before accessing or touching interior areas of the printer.



**3** Remove the pick roller.

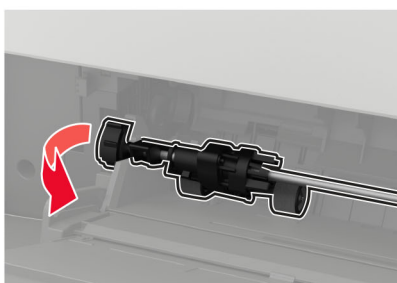

**4** Apply isopropyl alcohol to a soft, lint-free cloth, and then wipe the pick roller.

**5** Insert the pick roller.

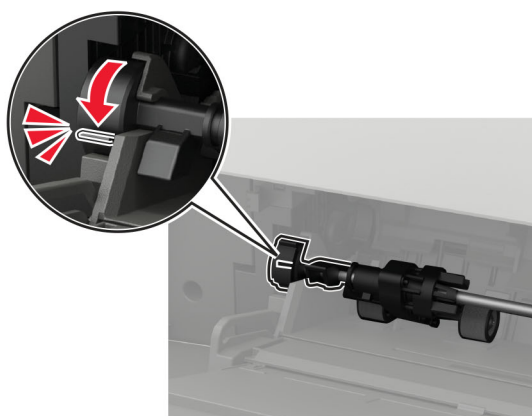
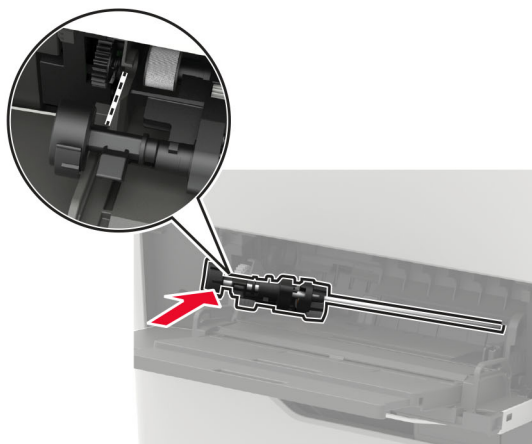
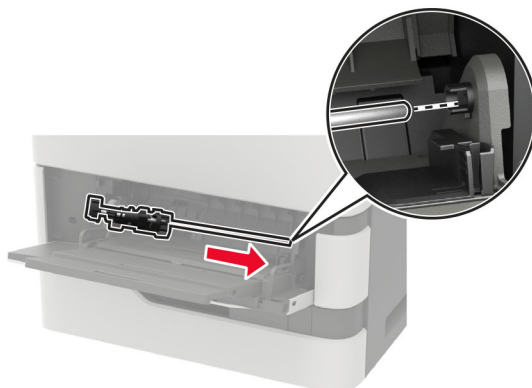

**6** Close the multipurpose feeder.

**7** Turn on the printer.



## Cleaning the ADF pick roller

- 1 Turn off the printer.
- 2 Open door D.

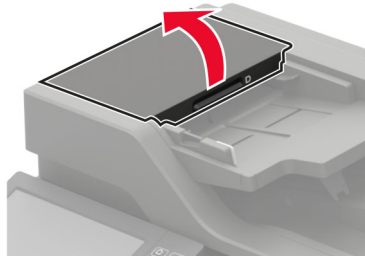

- 3 Remove the ADF pick roller cover.

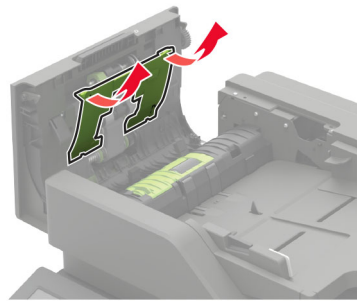

- 4 Remove the ADF pick roller.

**Warning—Potential Damage:** Some parts of the printer are easily damaged by static electricity. Before touching any parts or components in an area marked with the static-sensitive symbol, touch a metal surface in an area away from the symbol.

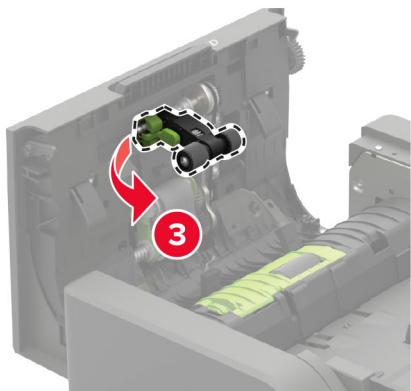
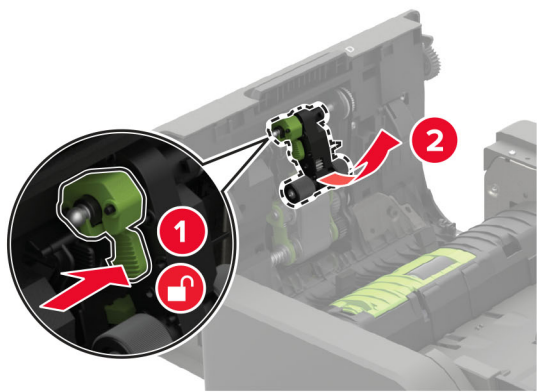

5 Apply isopropyl alcohol to a soft, lint-free cloth, and then wipe the ADF pick roller..

6 Insert the ADF pick roller until it *clicks* into place.

**Warning—Potential Damage:** Some parts of the printer are easily damaged by static electricity. Before touching any parts or components in an area marked with the static-sensitive symbol, touch a metal surface in an area away from the symbol.

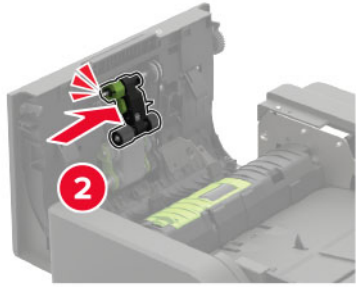
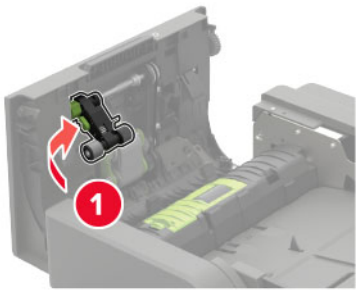

**7** Insert the ADF pick roller cover until it *clicks* into place.

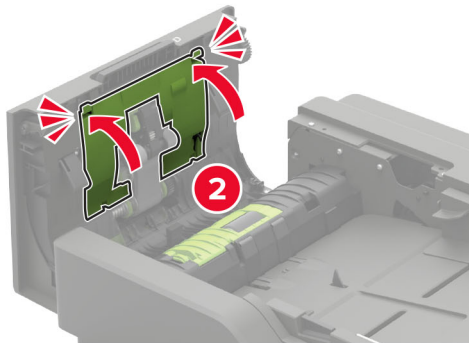
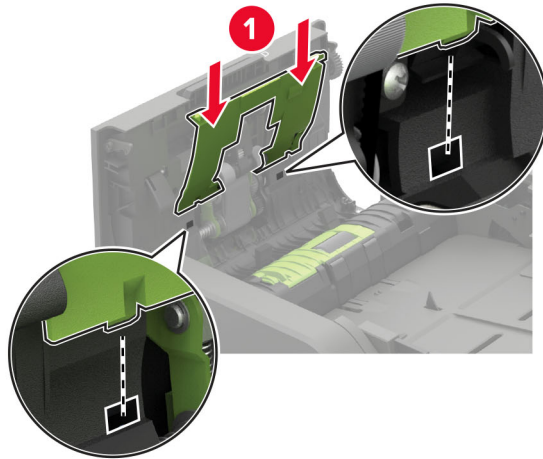

**8** Close door D.

**9** Turn on the printer.

## Cleaning the ADF feed roller

**1** Turn off the printer.

**2** Open door D.

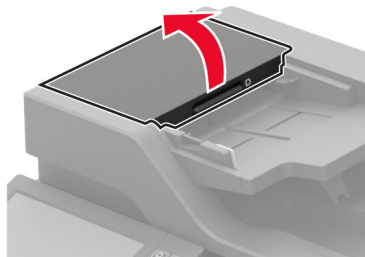

- 3 Remove the ADF pick roller cover.

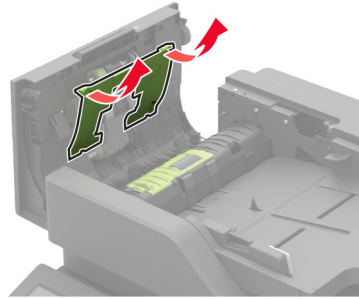

- 4 Remove the ADF feed roller.

**Warning—Potential Damage:** Some parts of the printer are easily damaged by static electricity. Before touching any parts or components in an area marked with the static-sensitive symbol, touch a metal surface in an area away from the symbol.

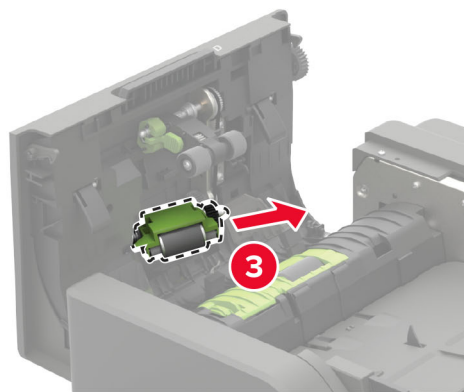
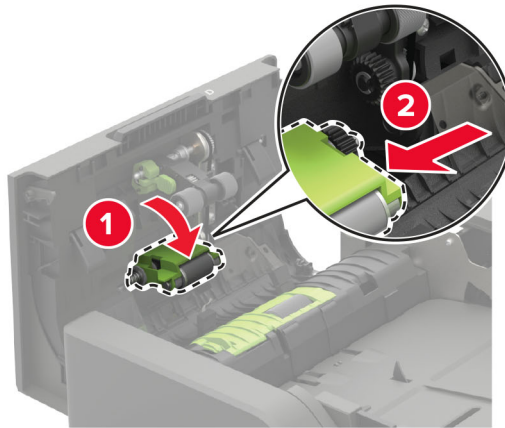

- 5 Apply isopropyl alcohol to a soft, lint-free cloth, and then wipe the ADF feed roller.

6 Insert the ADF feed roller until it *clicks* into place.

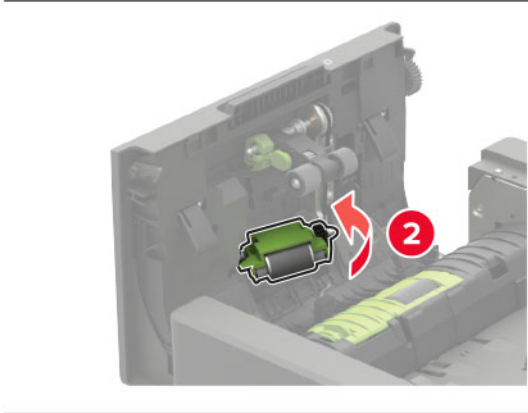
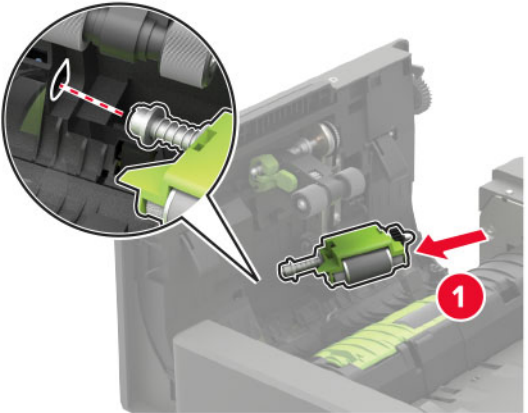

**7** Insert the ADF pick roller cover until it *clicks* into place.

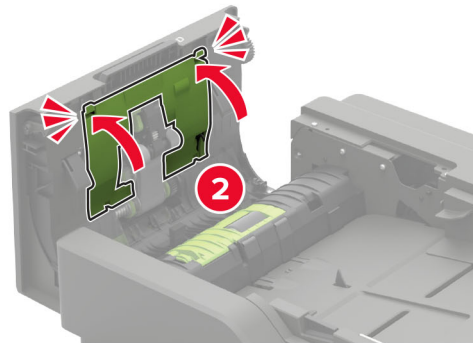
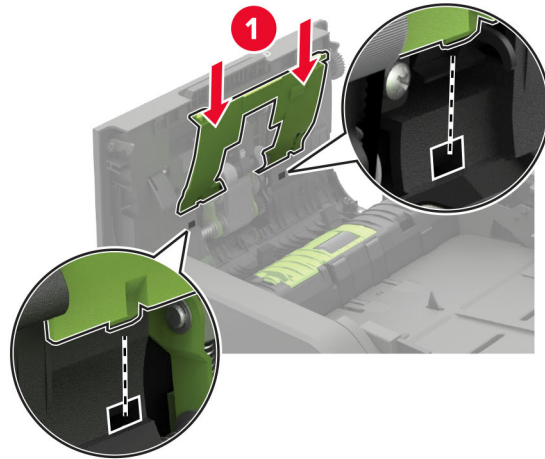

**8** Close door D.

**9** Turn on the printer.

## Emptying the hole punch box

**1** Open door J.



**2** Remove and empty the hole punch box.

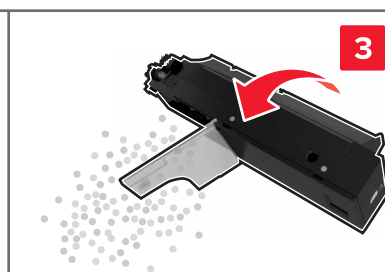
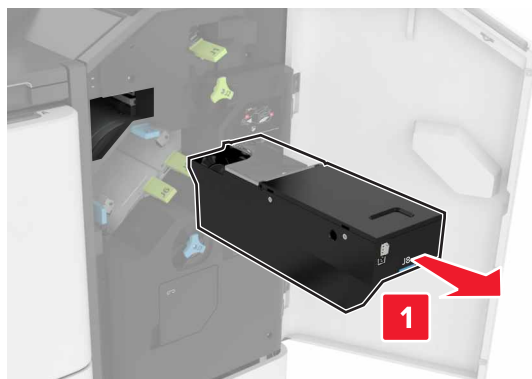

**3** Insert the hole punch box.

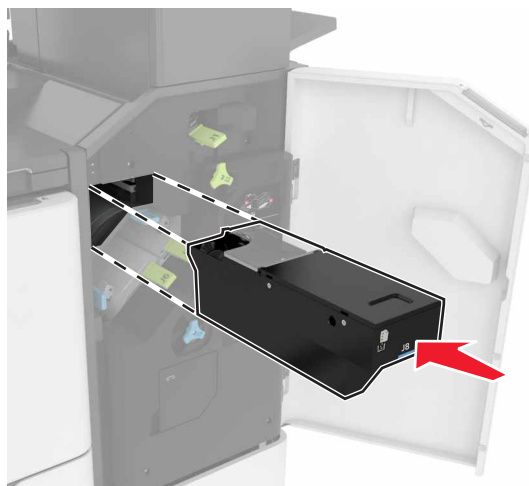

**4** Close door J.

## Ordering parts and supplies

To order parts and supplies in the U.S., contact Lexmark at 1-800-539-6275 for information about Lexmark authorized supplies dealers in your area. In other countries or regions, go to [www.lexmark.com](http://www.lexmark.com) or contact the place where you purchased the printer.

**Note:** All life estimates for printer supplies assume printing on letter- or A4-size plain paper.

## Checking the status of parts and supplies

- 1 From the home screen, touch **Status/Supplies**.
- 2 Select the parts or supplies that you want to check.

**Note:** You can also access this setting by touching the top section of the home screen.

## Using genuine Lexmark parts and supplies

Your Lexmark printer is designed to function best with genuine Lexmark parts and supplies. Use of third-party supplies or parts may affect the performance, reliability, or life of the printer and its imaging components. It can also affect warranty coverage. Damage caused by the use of third-party parts and supplies is not covered by the warranty. All life indicators are designed to function with Lexmark parts and supplies, and may deliver unpredictable results if third-party parts and supplies are used. Imaging component usage beyond the intended life may damage your Lexmark printer or its associated components.

**Warning—Potential Damage:** Supplies and parts without Return Program agreement terms may be reset and remanufactured. However, the manufacturer's warranty does not cover any damage caused by non-genuine supplies or parts. Resetting counters on the supply or part without proper remanufacturing can cause damage to your printer. After resetting the supply or part counter, your printer may display an error indicating the presence of the reset item.

## Ordering a toner cartridge

### Notes:

- The estimated cartridge yield is based on the ISO/IEC 19752 standard.
- Extremely low print coverage for extended periods of time may negatively affect actual yield.

### Return Program toner cartridges

Item	United States and Canada	European Economic Area	Asia Pacific	Latin America	Rest of Europe, Middle East, and Africa	Australia and New Zealand	Worldwide
Return Program toner cartridge	58D1000	58D2000	58D3000	58D4000	58D5000	58D6000	58D000G

<sup>1</sup> Available only for contract-managed printers. For more information, contact your Lexmark representative or system administrator.



Item	United States and Canada	European Economic Area	Asia Pacific	Latin America	Rest of Europe, Middle East, and Africa	Australia and New Zealand	Worldwide
High yield Return Program toner cartridge	58D1H00	58D2H00	58D3H00	58D4H00	58D5H00	58D6H00	58D0H0G
High yield Corporate Return Program toner cartridge <sup>1</sup>	58D1H0E	58D2H0E	58D3H0E	58D4H0E	58D5H0E	58D6H0E	N/A
Extra high yield Return Program toner cartridge	58D1X00	58D2X00	58D3X00	58D4X00	58D5X00	58D6X00	58D0X0G
Extra high yield Corporate Return Program toner cartridge <sup>1</sup>	58D1X0E	58D2X0E	58D3X0E	58D4X0E	58D5X0E	58D6X0E	N/A
Ultra high yield Return Program toner cartridge	58D1U00	58D2U00	58D3U00	58D4U00	58D5U00	58D6U00	58D0U0G
Ultra high yield Corporate Return Program toner cartridge <sup>1</sup>	58D1U0E	58D2U0E	58D3U0E	58D4U0E	58D5U0E	58D6U0E	N/A

<sup>1</sup> Available only for contract-managed printers. For more information, contact your Lexmark representative or system administrator.

### Lexmark XM7355 and XM7370 Return Program toner cartridges

Item	United States, Canada, Australia, and New Zealand	Europe, Middle East, and Africa	Asia Pacific	Latin America
Return Program toner cartridge	25B3086 <sup>1</sup> 25B3090 <sup>2</sup>	25B3101 <sup>1</sup> 25B3107 <sup>2</sup>	25B3121 <sup>1</sup> 25B3122 <sup>2</sup>	25B3128 <sup>1</sup> 25B3129 <sup>2</sup>
<sup>1</sup> Supported only in the Lexmark XM7355 printer model. <sup>2</sup> Supported only in the Lexmark XM7370 printer model.				

### Regular toner cartridges

Item	Worldwide
Ultra high yield toner cartridge	58D0UA0

### Ordering an imaging unit

Extremely low print coverage for extended periods of time may cause imaging unit parts to fail before the toner exhaustion.

Item	Lexmark Return Program	Corporate Return Program*	Regular
Imaging unit	58D0Z00	58D0Z0E	58D0ZA0
* This imaging unit is available only for contract-managed printers. For more information, contact your Lexmark representative or system administrator.			

### Ordering a staple cartridge

Part name	Part number
Staple cartridge	35S8500

### Ordering a maintenance kit

To identify the supported fuser type, open door A, and then remove the toner cartridge and the imaging unit. Find the two-digit fuser type in front of the fuser, for example, 00 or 01.

**Warning—Potential Damage:** Do not expose the imaging unit to direct light for more than 10 minutes. Extended exposure to light may cause print quality problems.

#### Notes:

- Using certain types of paper may require more frequent replacement of the maintenance kit.
- The separator assembly, fuser, pick roller assembly, and transfer roller are included in the maintenance kit and can be ordered individually and replaced if necessary.
- For more information on replacing the maintenance kit, see the documentation that came with the kit.

**Return Program fuser maintenance kits**

Fuser maintenance kit type	Part number
Type 00	41X2233
Type 01	41X2234
Type 02	41X2235
Type 03	41X2236
Type 04	41X2237
Type 11	41X2242
Type 13	41X2243
Type 32	41X2250
Type 33	41X2251
Type 35	41X2252
Type 36	41X2253

**Regular fuser maintenance kits**

Fuser maintenance kit type	Part number
Type 05	41X2238
Type 06	41X2239
Type 07	41X2240
Type 08	41X2241
Type 17	41X2244
Type 19	41X2245

**Roller maintenance kit**

Item	Part number
Printer engine roller maintenance kit	41X2352

**Automatic document feeder maintenance kit**

Item	Part number
ADF maintenance kit	41X2351

# Replacing parts and supplies

## Replacing the toner cartridge

- 1 Open door A.

**Warning—Potential Damage:** To prevent damage from electrostatic discharge, touch any exposed metal frame of the printer before accessing or touching interior areas of the printer.

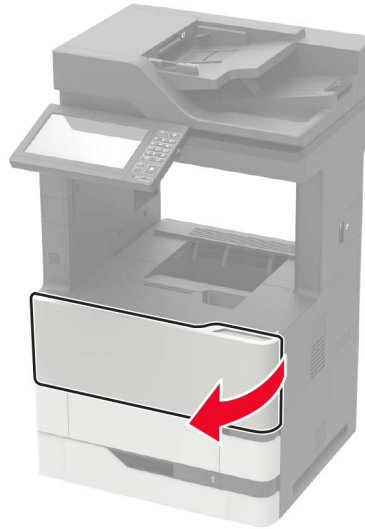

- 2 Remove the used toner cartridge.

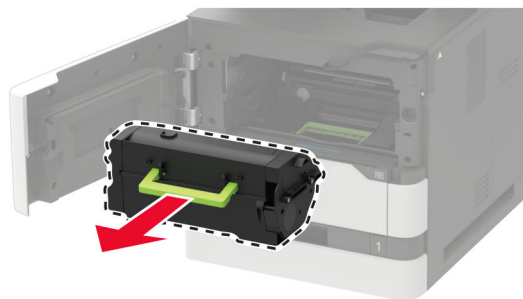

- 3 Unpack the new toner cartridge, and then shake it to redistribute the toner.

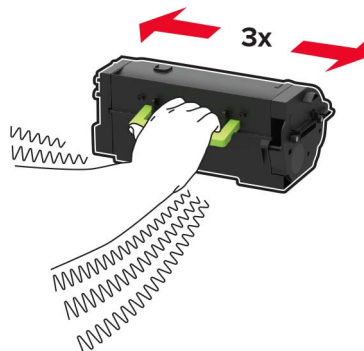

- 4 Insert the new toner cartridge.

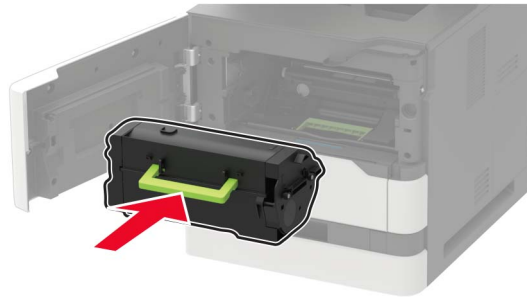

- 5 Close the door.

## Replacing the imaging unit

- 1 Open door A.

**Warning—Potential Damage:** To prevent damage from electrostatic discharge, touch any exposed metal frame of the printer before accessing or touching interior areas of the printer.

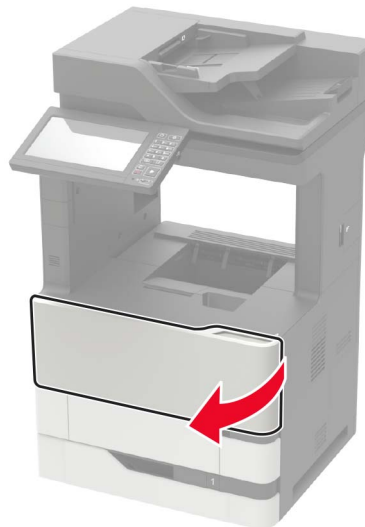

- 2 Remove the toner cartridge.

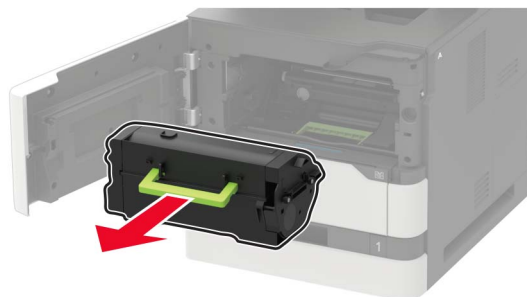

- 3 Remove the used imaging unit.

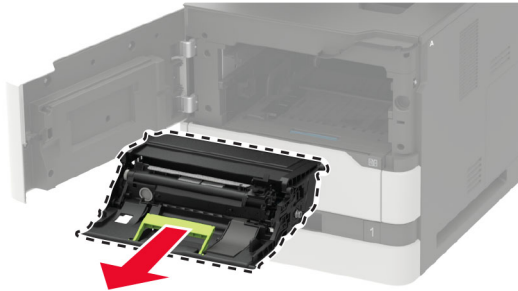

- 4 Unpack the new imaging unit, and then shake it to redistribute the toner.

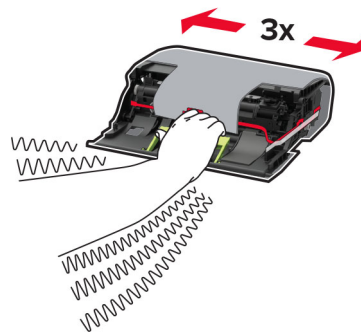

**Warning—Potential Damage:** Do not expose the imaging unit to direct light for more than 10 minutes. Extended exposure to light may cause print quality problems.

**Warning—Potential Damage:** Do not touch the photoconductor drum. Doing so may affect the quality of future print jobs.



- 5 Remove the packing material.

- 6 Insert the new imaging unit.



- 7 Insert the toner cartridge.

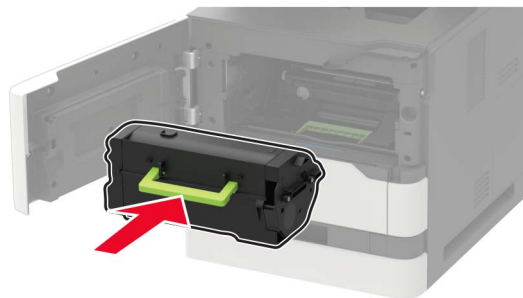

- 8 Close the door.

## Replacing the fuser

- 1 Open door C.

 **CAUTION—HOT SURFACE:** The inside of the printer might be hot. To reduce the risk of injury from a hot component, allow the surface to cool before touching it.

**Warning—Potential Damage:** To prevent damage from electrostatic discharge, touch any exposed metal frame of the printer before accessing or touching interior areas of the printer.

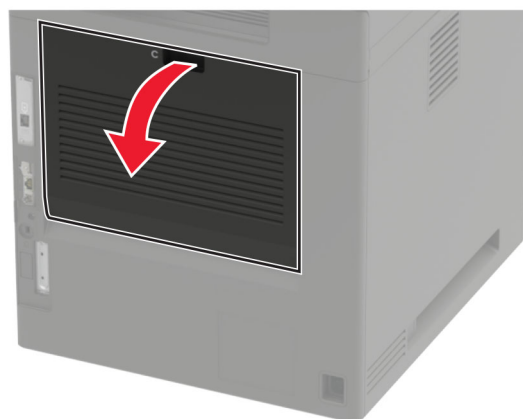

**2** Unlock the fuser.

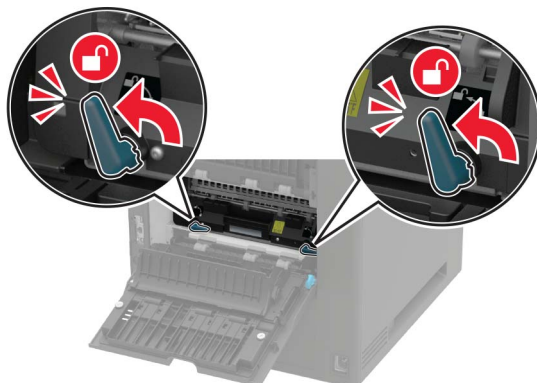

**3** Remove the used fuser.

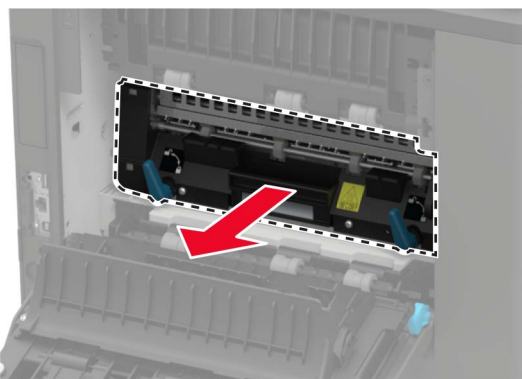

**4** Unpack the new fuser.

**5** Insert the new fuser until it *clicks* into place.

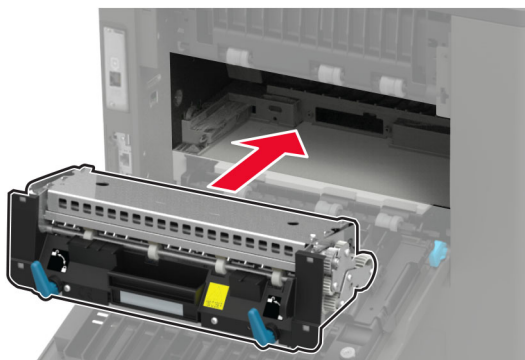



- 6 Lock the fuser.

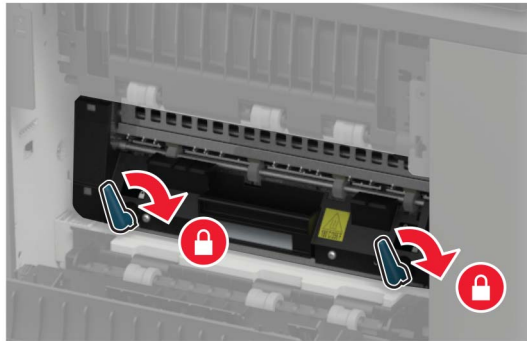

- 7 Close the door.

## Replacing the transfer roller

- 1 Open door A.

**Warning—Potential Damage:** To prevent damage from electrostatic discharge, touch any exposed metal frame of the printer before accessing or touching interior areas of the printer.

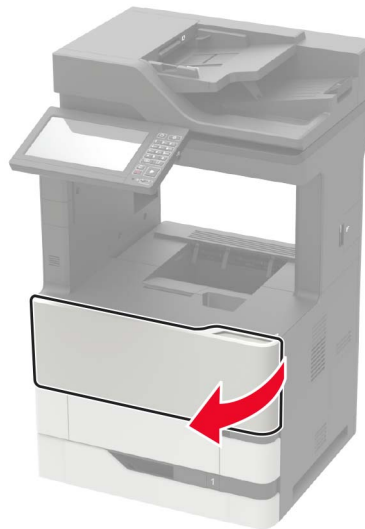

- 2 Remove the toner cartridge.

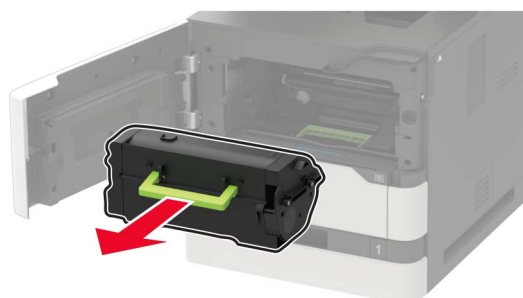

3 Remove the imaging unit.



4 Remove the used transfer roller.

 **CAUTION—HOT SURFACE:** The inside of the printer might be hot. To reduce the risk of injury from a hot component, allow the surface to cool before touching it.

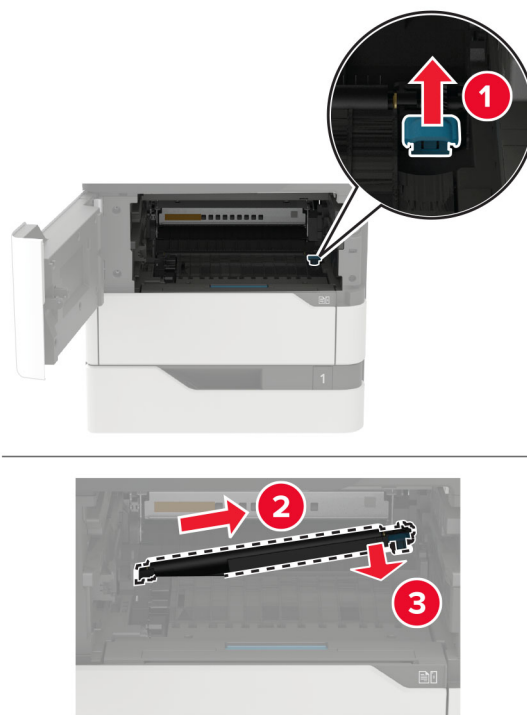

5 Unpack the new transfer roller.

**6** Insert the new transfer roller until it *clicks* into place.

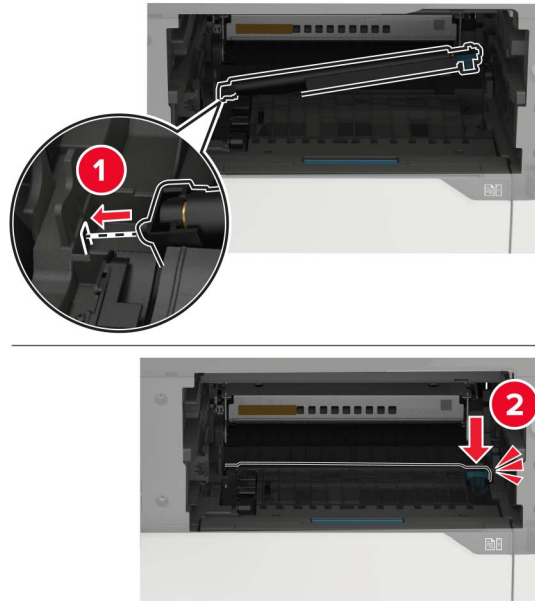

**7** Insert the imaging unit.

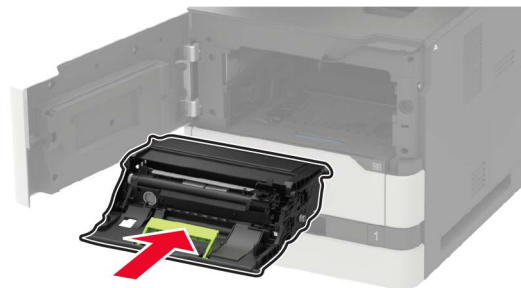

**8** Insert the toner cartridge.

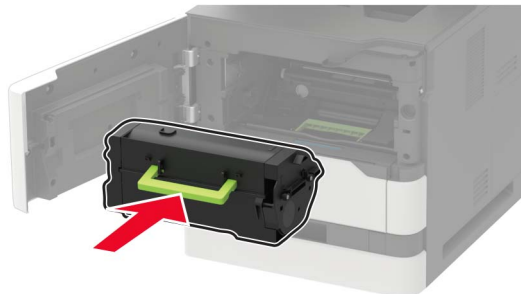

**9** Close the door.

## Replacing the pick roller

**1** Remove the tray.

**Warning—Potential Damage:** To prevent damage from electrostatic discharge, touch any exposed metal frame of the printer before accessing or touching interior areas of the printer.



**2** Remove the used pick roller.

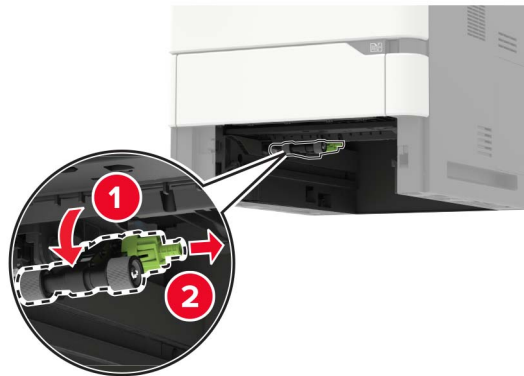

**3** Unpack the new pick roller.

**4** Install the new pick roller.

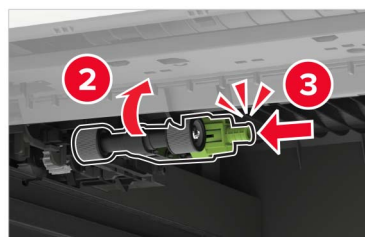

**5** Insert the tray.

## Replacing the pick roller in the multipurpose feeder

- 1 Open the multipurpose feeder.

**Warning—Potential Damage:** To prevent damage from electrostatic discharge, touch any exposed metal frame of the printer before accessing or touching interior areas of the printer.



- 2 Remove the used pick roller.

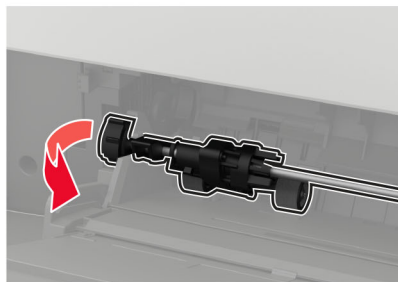

- 3 Unpack the new pick roller.

4 Install the new pick roller.

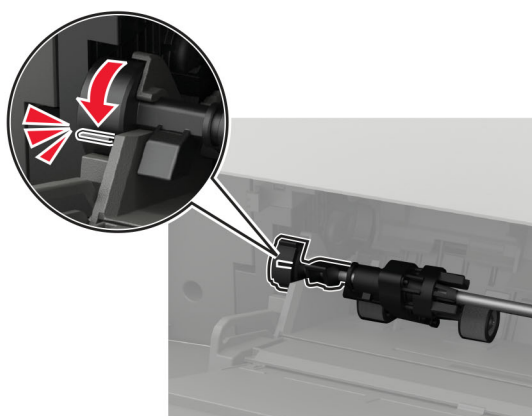
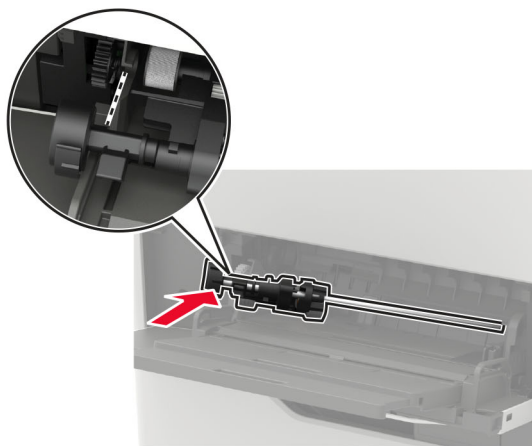
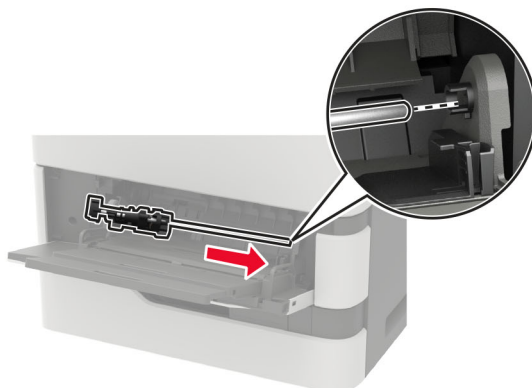

5 Close the multipurpose feeder.

### Replacing the ADF pick roller

- 1 Turn off the printer.
- 2 Open door D.

**Warning—Potential Damage:** To prevent damage from electrostatic discharge, touch any exposed metal frame of the printer before accessing or touching interior areas of the printer.

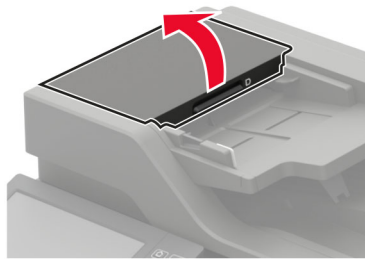

**3** Remove the ADF pick roller cover.

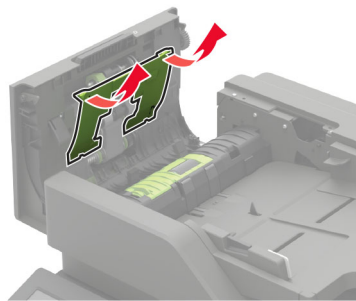

**4** Remove the used ADF pick roller.

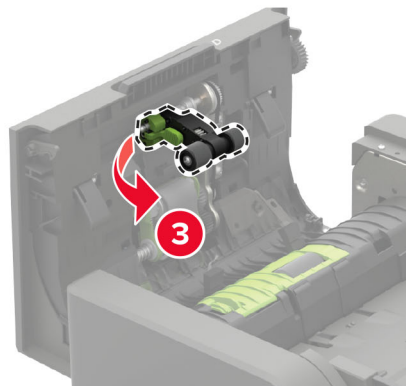
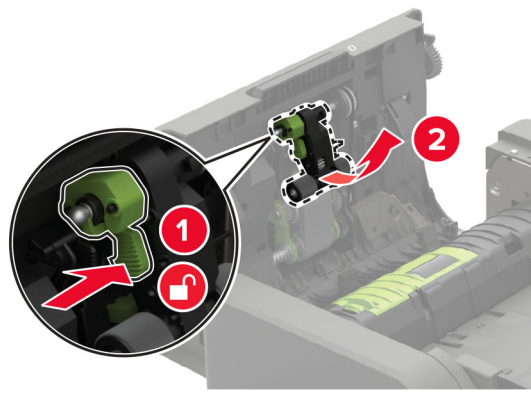

5 Unpack the new ADF pick roller.

**Warning—Potential Damage:** To avoid damage and poor printer performance, handle this part with clean hands.

6 Insert the new ADF pick roller until it *clicks* into place.

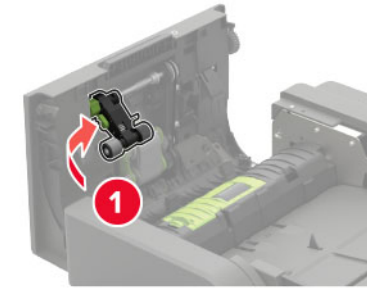



7 Insert the ADF pick roller cover until it *clicks* into place.

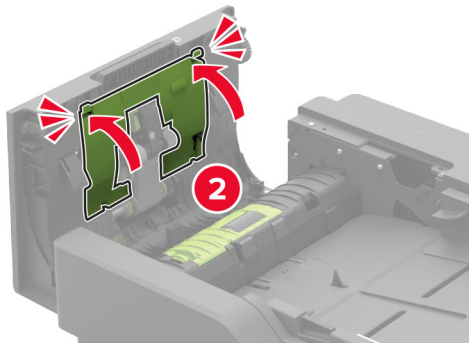
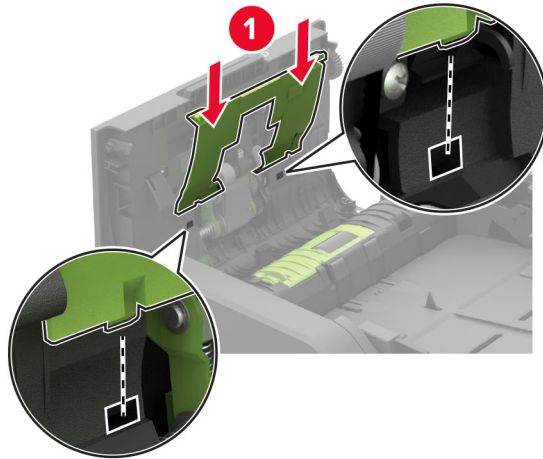

8 Close the door.

9 Turn on the printer.

## Replacing the ADF feed roller

1 Turn off the printer.

2 Open door D.

**Warning—Potential Damage:** To prevent damage from electrostatic discharge, touch any exposed metal frame of the printer before accessing or touching interior areas of the printer.

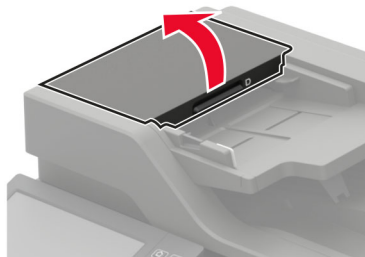

3 Remove the ADF pick roller cover.

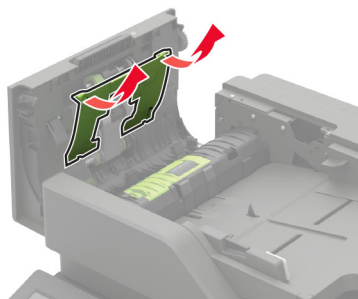

4 Remove the used ADF feed roller.

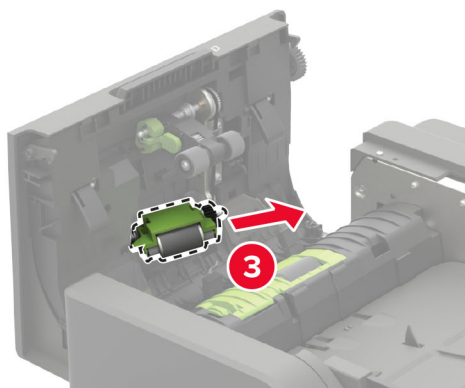
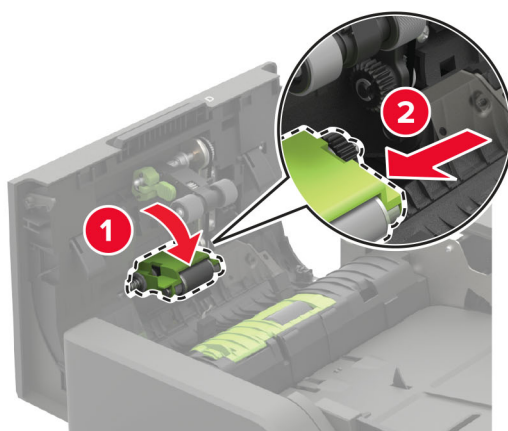

5 Unpack the new ADF feed roller.

**Warning—Potential Damage:** To avoid damage and poor printer performance, handle this part with clean hands.

**6** Insert the new ADF feed roller until it *clicks* into place.

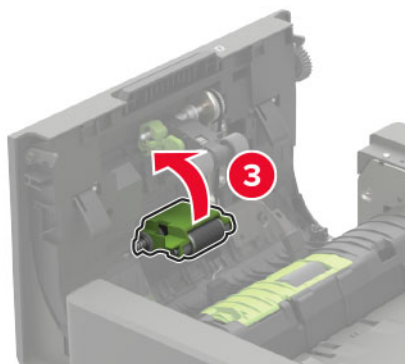
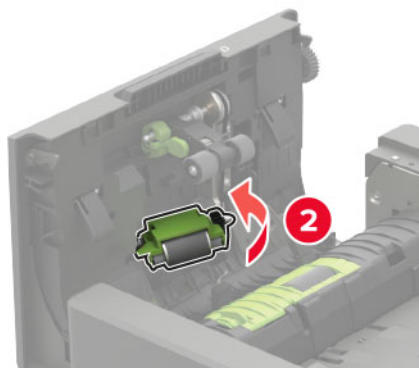
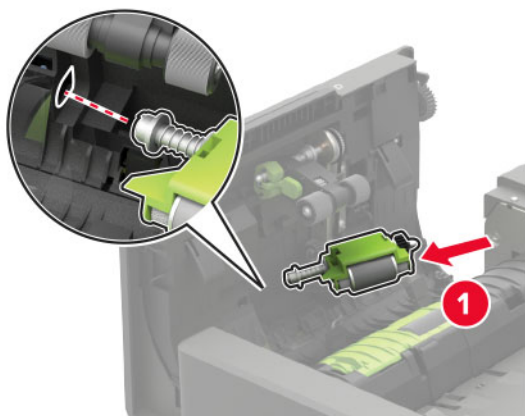

7 Insert the ADF pick roller cover until it *clicks* into place.

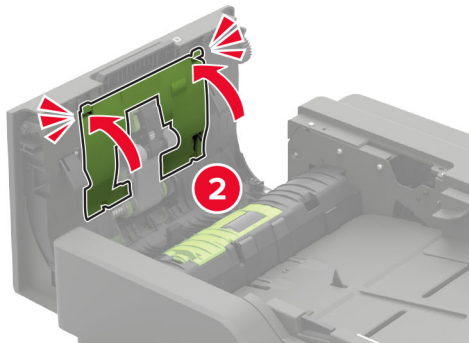
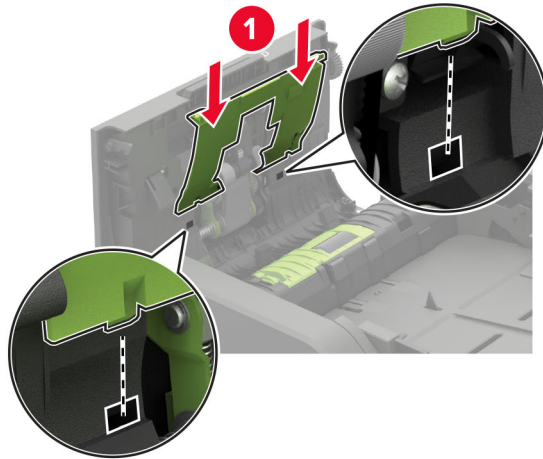

8 Close the door.

9 Turn on the printer.

## Replacing the ADF separator roller

1 Turn off the printer.

2 Open door D.

**Warning—Potential Damage:** To prevent damage from electrostatic discharge, touch any exposed metal frame of the printer before accessing or touching interior areas of the printer.

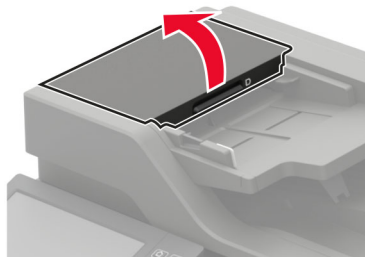

- 3 Remove the ADF separator roller cover.

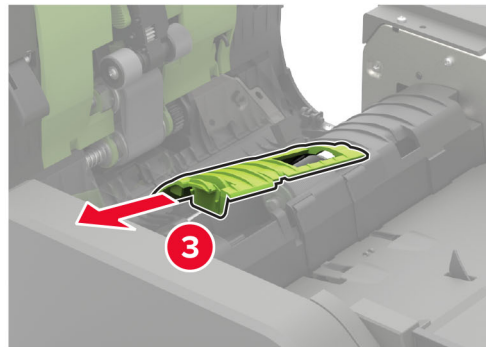
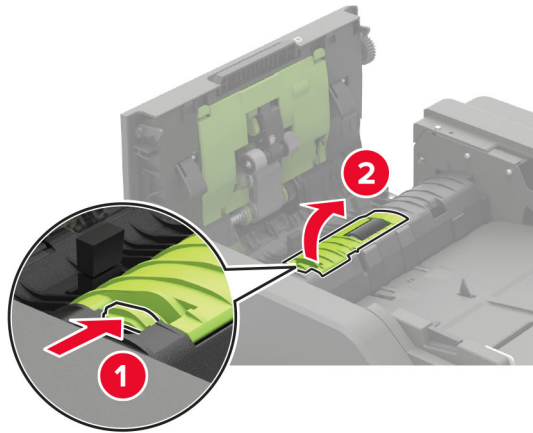

- 4 Remove the used ADF separator roller.

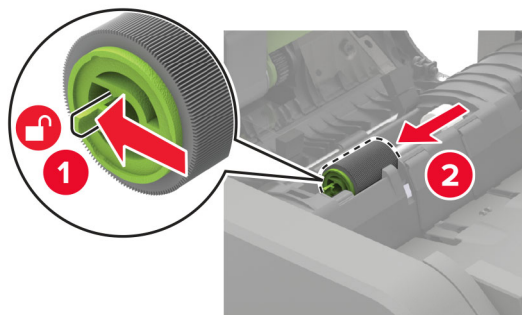

- 5 Unpack the new ADF separator roller.

**Warning—Potential Damage:** To avoid damage and poor printer performance, handle this part with clean hands.

**6** Insert the new ADF separator roller until it *clicks* into place.

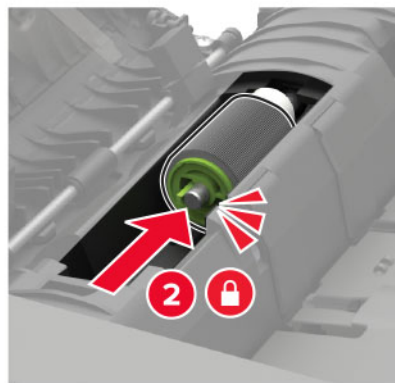
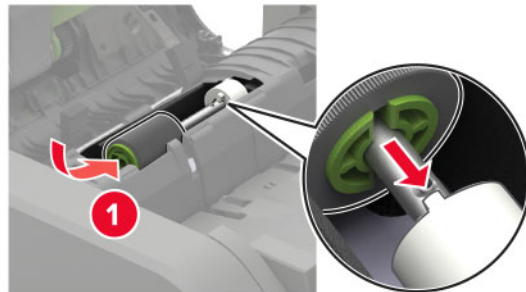

**7** Insert the ADF separator roller cover until it *clicks* into place.

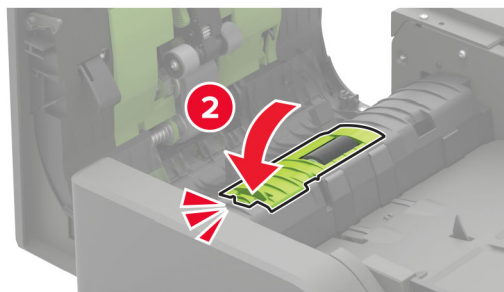
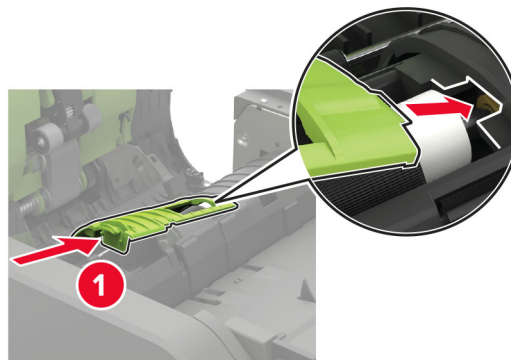

- 8 Close the door.
- 9 Turn on the printer.

## Replacing the ADF torque limiter

- 1 Turn off the printer.
- 2 Open door D.

**Warning—Potential Damage:** To prevent damage from electrostatic discharge, touch any exposed metal frame of the printer before accessing or touching interior areas of the printer.

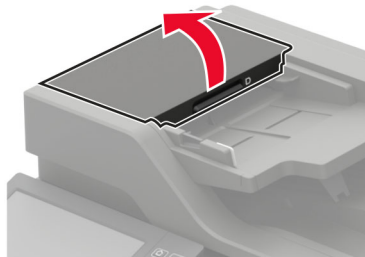

- 3 Remove the ADF separator roller cover.

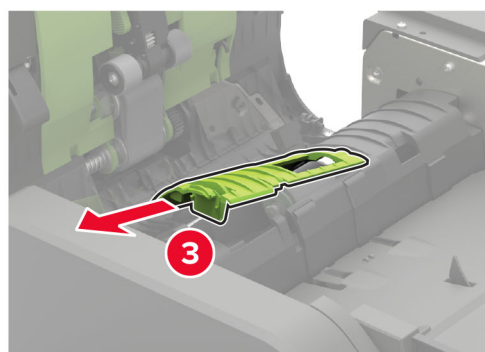
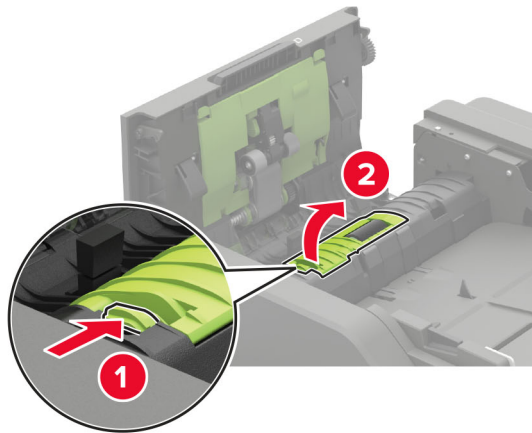

- 4 Remove the ADF separator roller.

**Warning—Potential Damage:** To avoid damage and poor printer performance, handle this part with clean hands.

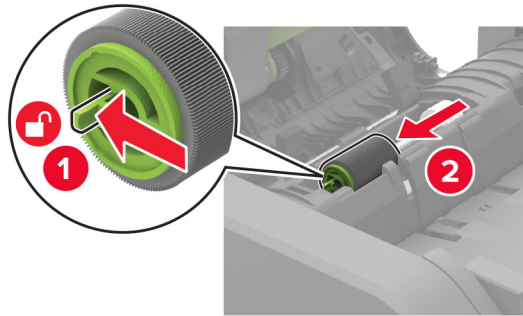

- 5 Remove the used ADF torque limiter.

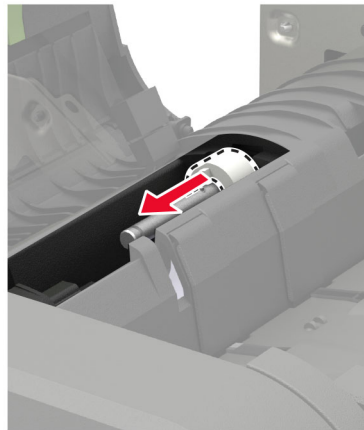

- 6 Unpack the new ADF torque limiter.

**Warning—Potential Damage:** To avoid damage and poor printer performance, handle this part with clean hands.

- 7 Insert the new ADF torque limiter.

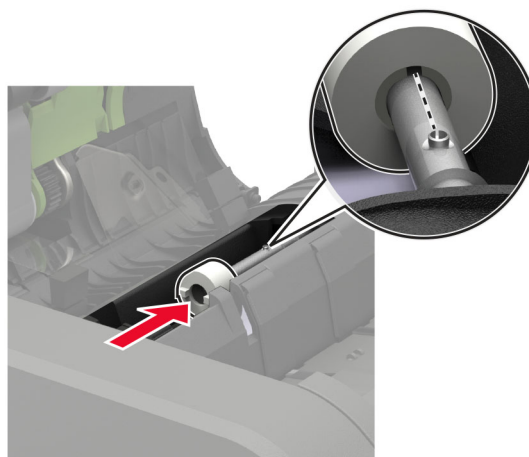



**8** Insert the ADF separator roller until it *clicks* into place.

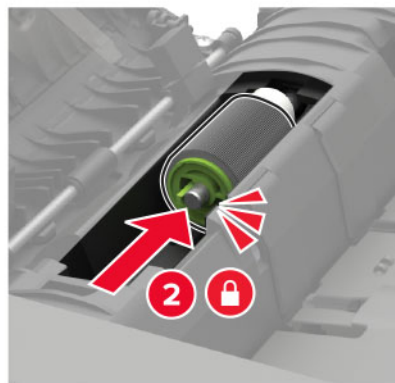
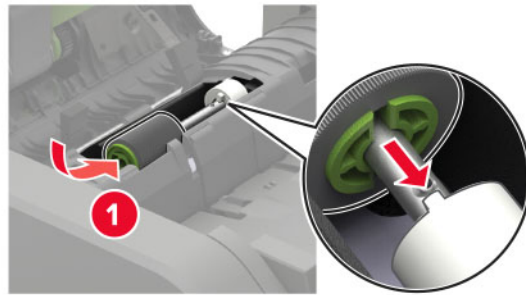

**9** Insert the ADF separator roller cover until it *clicks* into place.

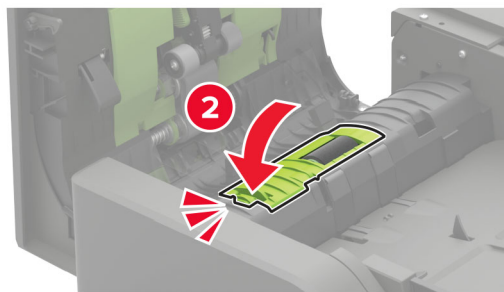
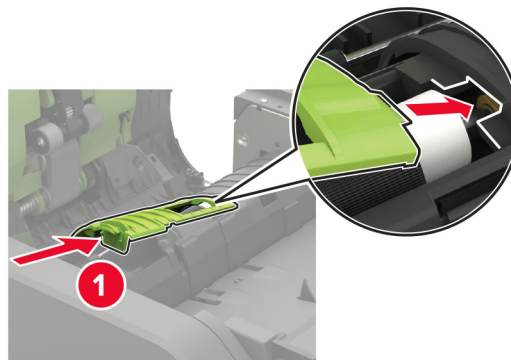

**10** Close the door.

**11** Turn on the printer.

## Replacing the staple cartridge in the staple finisher

**1** Open door F.



**2** Remove the staple cartridge holder.

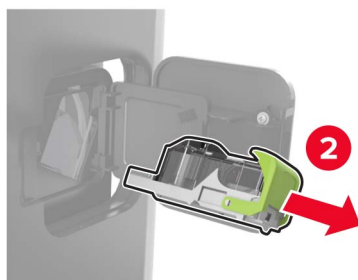
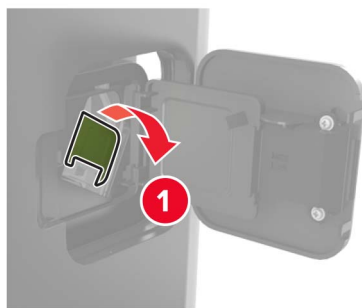

**3** Remove the empty staple cartridge.

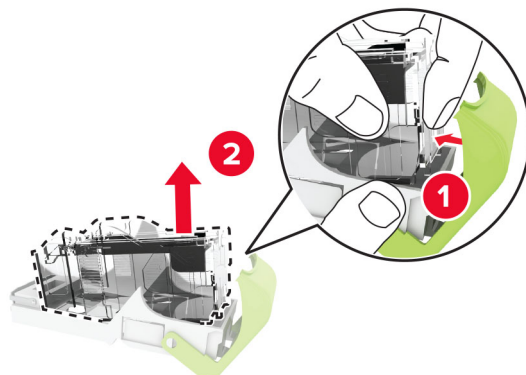

**4** Insert the new staple cartridge.

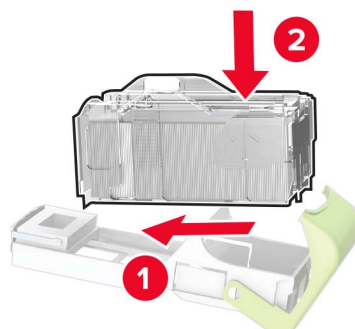

**5** Insert the staple cartridge holder.

**6** Close the door.

## Replacing the staple cartridge in the staple, hole punch finisher

1 Depending on the staple cartridge to replace, open either door F or door G.

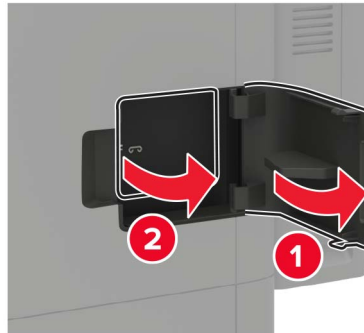

2 Remove the staple cartridge holder.

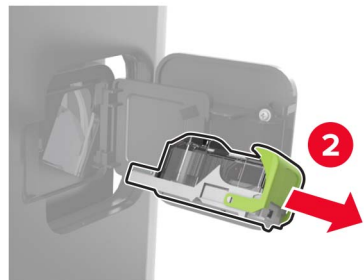
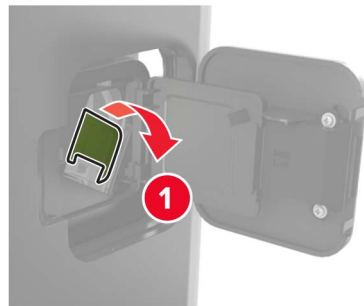

- 3 Remove the empty staple cartridge.

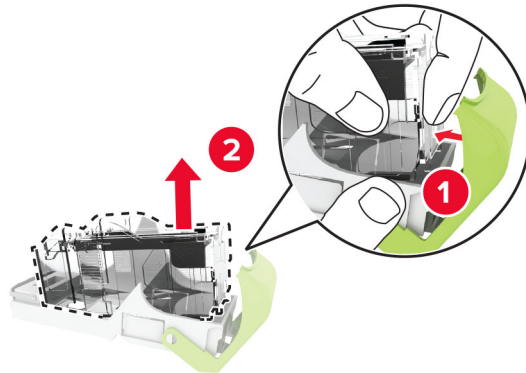

- 4 Insert the new staple cartridge.

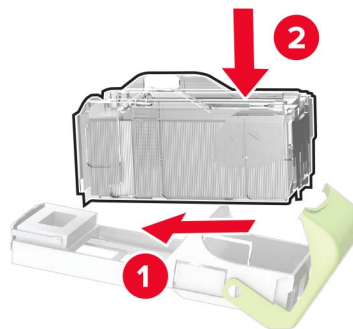

- 5 Insert the staple cartridge holder.

- 6 Close the door.

## Resetting the supply usage counters

- 1 From the home screen, touch **Settings** > **Device** > **Maintenance** > **Configuration Menu** > **Supply Usage And Counters**.
- 2 Select the counter that you want to reset.

**Warning—Potential Damage:** Supplies and parts without Return Program agreement terms may be reset and remanufactured. However, the manufacturer's warranty does not cover any damage caused by non-genuine supplies or parts. Resetting counters on the supply or part without proper remanufacturing can cause damage to your printer. After resetting the supply or part counter, your printer may display an error indicating the presence of the reset item.

## Moving the printer

Moving the printer to another location

## Moving the printer to another location

 **CAUTION—POTENTIAL INJURY:** If the printer weight is greater than 20 kg (44 lb), then it may require two or more people to lift it safely.

 **CAUTION—POTENTIAL INJURY:** To avoid the risk of fire or electrical shock, use only the power cord provided with this product or the manufacturer's authorized replacement.

 **CAUTION—POTENTIAL INJURY:** When moving the printer, follow these guidelines to avoid personal injury or printer damage:

- Make sure that all doors and trays are closed.
- Turn off the printer, and then unplug the power cord from the electrical outlet.
- Disconnect all cords and cables from the printer.
- If the printer has separate floor-standing optional trays or output options attached to it, then disconnect them before moving the printer.
- If the printer has a caster base, then carefully roll it to the new location. Use caution when passing over thresholds and breaks in flooring.
- If the printer does not have a caster base but is configured with optional trays or output options, then remove the output options and lift the printer off the trays. Do not try to lift the printer and any options at the same time.
- Always use the handholds on the printer to lift it.
- Any cart used to move the printer must have a surface able to support the full footprint of the printer.
- Any cart used to move the hardware options must have a surface able to support the dimensions of the options.
- Keep the printer in an upright position.
- Avoid severe jarring movements.
- Make sure that your fingers are not under the printer when you set it down.
- Make sure that there is adequate clearance around the printer.

**Note:** Damage to the printer caused by improper moving is not covered by the printer warranty.

## Shipping the printer

For shipping instructions, go to <http://support.lexmark.com> or contact customer support.

## Saving energy and paper

### Configuring the power save mode settings

#### Sleep mode

- 1 From the home screen, touch **Settings > Device > Power Management > Timeouts > Sleep Mode**.
- 2 Specify the amount of time that the printer stays idle before it enters Sleep Mode.

## Hibernate mode

- 1 From the home screen, touch **Settings > Device > Power Management > Timeouts > Hibernate Timeout**.
- 2 Select the amount of time that the printer stays idle before it enters Hibernate mode.

### Notes:

- For Hibernate Timeout to work, set Hibernate Timeout on Connection to Hibernate.
- The Embedded Web Server is disabled when the printer is in Hibernate mode.

## Adjusting the brightness of the printer display

- 1 From the home screen, touch **Settings > Device > Preferences > Screen Brightness**.
- 2 Adjust the setting.

## Conserving supplies

- Print on both sides of the paper.  
**Note:** Two-sided printing is the default setting in the print driver.
- Print multiple pages on a single sheet of paper.
- Use the preview feature to see how the document looks like before printing it.
- Print one copy of the document to check its content and format for accuracy.

# Recycling

## Recycling Lexmark products

To return Lexmark products for recycling:

- 1 Go to [www.lexmark.com/recycle](http://www.lexmark.com/recycle).
- 2 Select the product you want to recycle.

**Note:** Printer supplies and hardware not listed in the Lexmark Collection and Recycling Program may be recycled through your local recycling center.

## Recycling Lexmark packaging

Lexmark continually strives to minimize packaging. Less packaging helps to ensure that Lexmark printers are transported in the most efficient and environmentally sensitive manner and that there is less packaging to dispose of. These efficiencies result in fewer greenhouse emissions, energy savings, and natural resource savings. Lexmark also offers recycling of packaging components in some countries or regions. For more information, go to [www.lexmark.com/recycle](http://www.lexmark.com/recycle), and then choose your country or region. Information on available packaging recycling programs is included with the information on product recycling.

Lexmark cartons are 100% recyclable where corrugated recycling facilities exist. Facilities may not exist in your area.

The foam used in Lexmark packaging is recyclable where foam recycling facilities exist. Facilities may not exist in your area.

When you return a cartridge to Lexmark, you can reuse the box that the cartridge came in. Lexmark recycles the box.



# Clearing jams

## Avoiding jams

### Load paper properly

- Make sure that the paper lies flat in the tray.

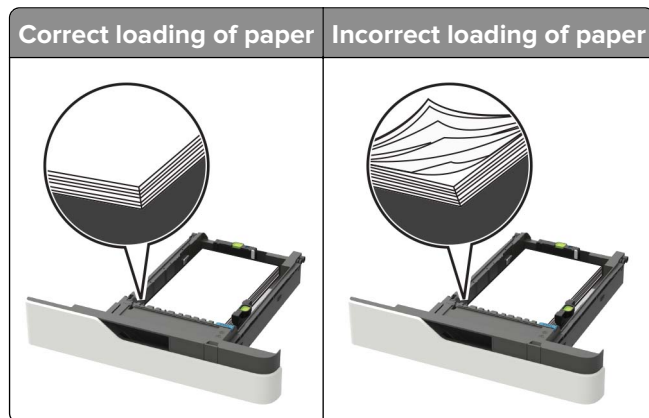

- Do not load or remove a tray while the printer is printing.
- Do not load too much paper. Make sure that the stack height is below the maximum paper fill indicator.
- Do not slide paper into the tray. Load paper as shown in the illustration.

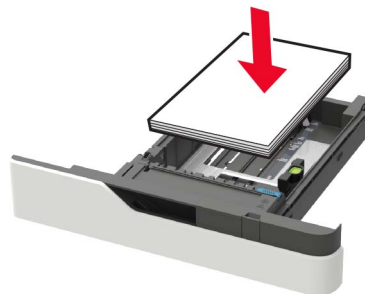

- Make sure that the paper guides are positioned correctly and are not pressing tightly against the paper or envelopes.
- Push the tray firmly into the printer after loading paper.

### Use recommended paper

- Use only recommended paper or specialty media.
- Do not load paper that is wrinkled, creased, damp, bent, or curled.
- Flex, fan, and align the paper edges before loading.

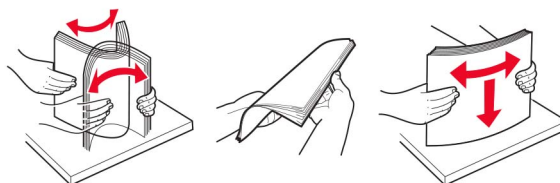

- Do not use paper that has been cut or trimmed by hand.
- Do not mix paper sizes, weights, or types in the same tray.
- Make sure that the paper size and type are set correctly on the computer or printer control panel.
- Store paper according to manufacturer recommendations.

## Identifying jam locations

### Notes:

- When Jam Assist is set to On, the printer flushes blank pages or pages with partial prints after a jammed page has been cleared. Check your printed output for blank pages.
- When Jam Recovery is set to On or Auto, the printer reprints jammed pages.

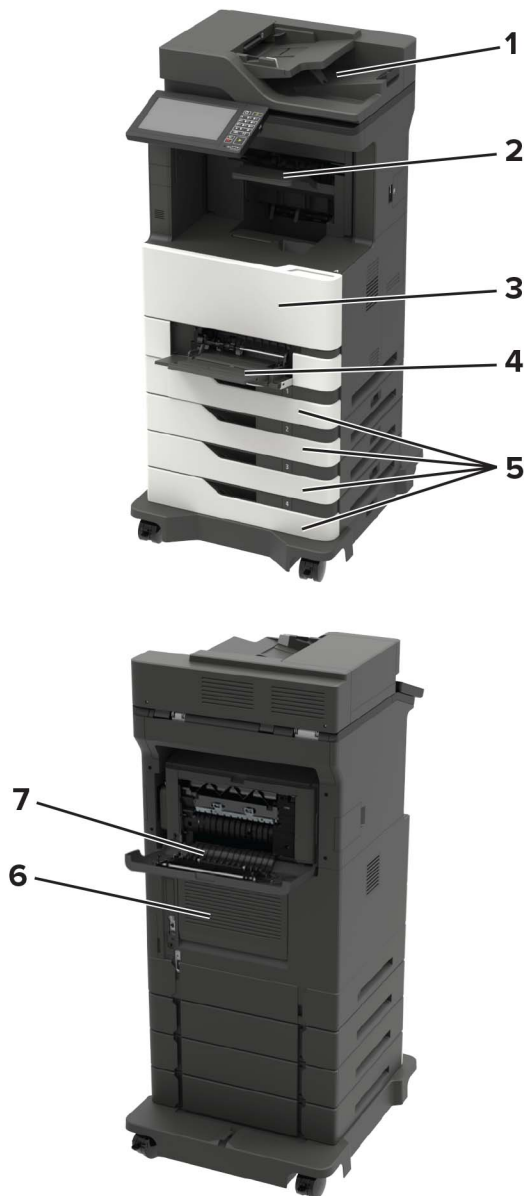

Jam locations	
1	Automatic document feeder
2	Standard, finisher, or output option bin
3	Door A
4	Multipurpose feeder
5	Trays
6	Door C
7	Finisher or output option rear door <ul style="list-style-type: none"> <li>• Door H</li> <li>• Door N</li> <li>• Door P</li> </ul>

## Paper jam in trays

- 1 Remove the tray.

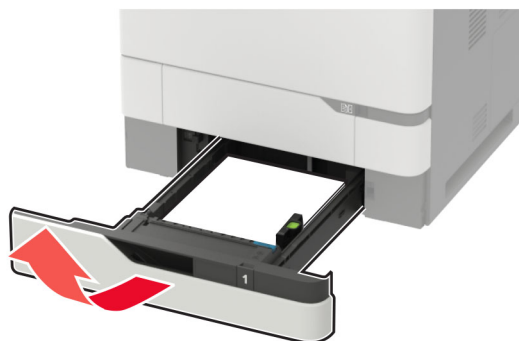

**Warning—Potential Damage:** A sensor inside the optional tray is easily damaged by static electricity. Touch a metal surface before removing the jammed paper in the tray.

- 2 Remove the jammed paper.

**Note:** Make sure that all paper fragments are removed.



- 3 Insert the tray.

Paper jam in door A

## Paper jam in door A

1 Open door A.

**Warning—Potential Damage:** To prevent damage from electrostatic discharge, touch any exposed metal frame of the printer before accessing or touching interior areas of the printer.

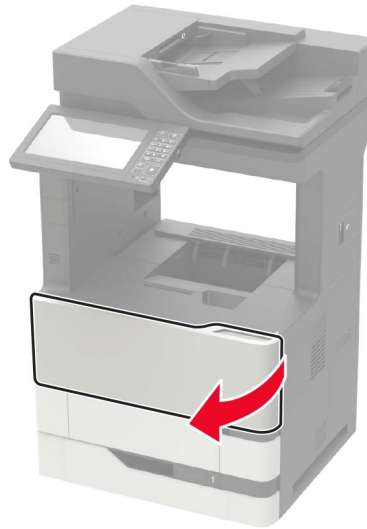

2 Remove the toner cartridge.

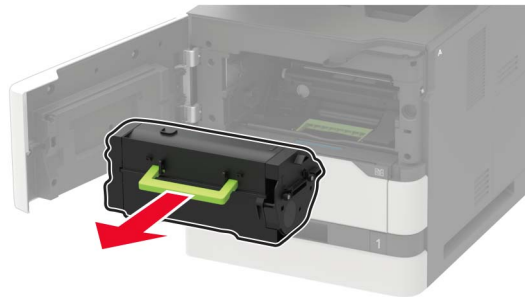

3 Remove the imaging unit.

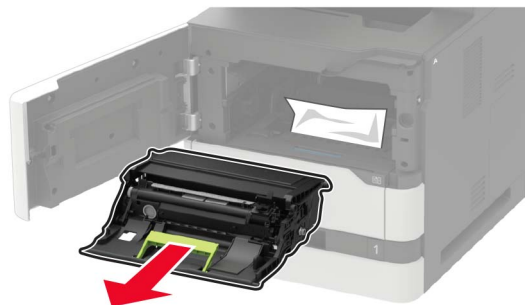

**Warning—Potential Damage:** Do not expose the imaging unit to direct light for more than 10 minutes. Extended exposure to light may cause print quality problems.

**Warning—Potential Damage:** Do not touch the photoconductor drum. Doing so may affect the quality of future print jobs.



**4** Pull out the duplex unit.

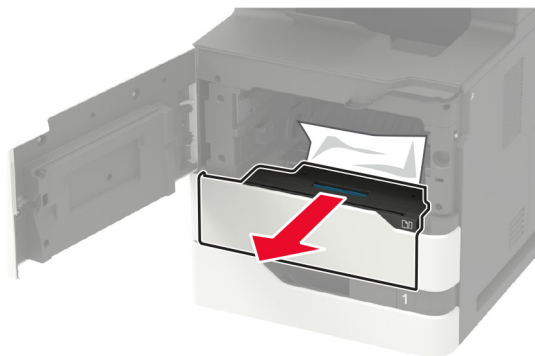

**5** Remove the jammed paper.

**Note:** Make sure that all paper fragments are removed.

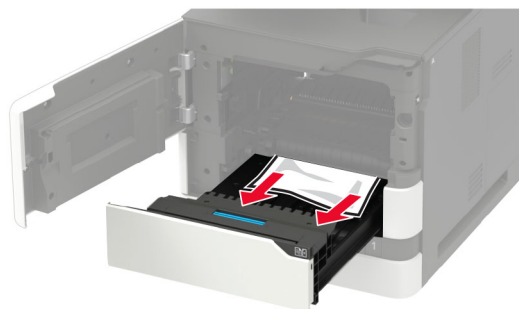

**6** Insert the duplex unit.

- 7 Insert the imaging unit.



- 8 Insert the toner cartridge.

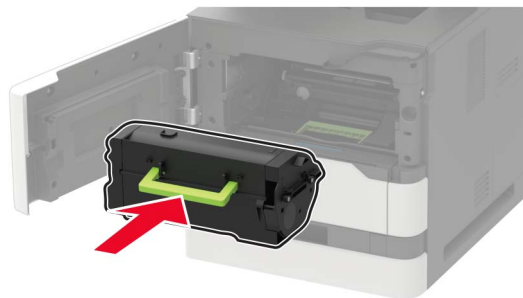

- 9 Close the door.

## Paper jam in door C

- 1 Open door C.

 **CAUTION—HOT SURFACE:** The inside of the printer might be hot. To reduce the risk of injury from a hot component, allow the surface to cool before touching it.

**Warning—Potential Damage:** To prevent damage from electrostatic discharge, touch any exposed metal frame of the printer before accessing or touching interior areas of the printer.

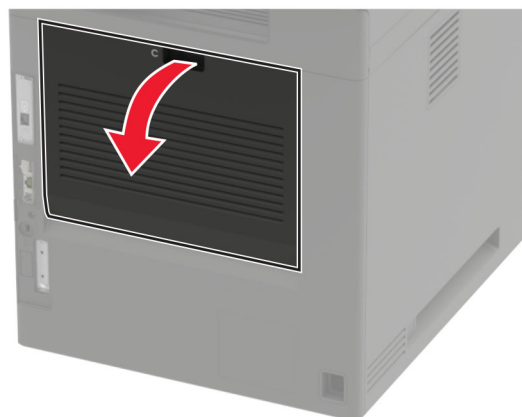

- 2 Remove the jammed paper from any of the following areas:

**Note:** Make sure that all paper fragments are removed.

- Fuser area



- Below the fuser area

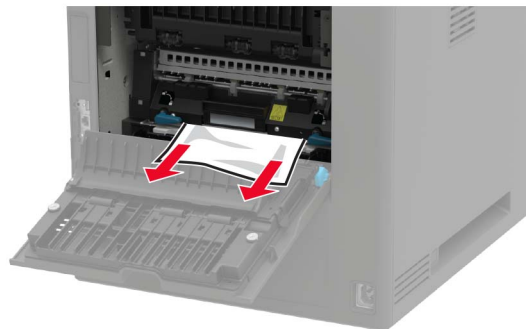

- Duplex area



**3** Close the door.

## Paper jam in the standard bin

Remove the jammed paper.

**Note:** Make sure that all paper fragments are removed.



## Paper jam in the multipurpose feeder

- 1 Remove paper from the multipurpose feeder.



- 2 Remove the jammed paper.

**Note:** Make sure that all paper fragments are removed.

- 3 Flex, fan, and align the paper edges before loading.

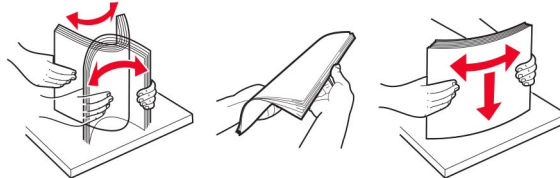



- 4 Reload paper.



## Paper jam in the automatic document feeder

- 1 Remove all original documents from the ADF tray.
- 2 Open door D.

**Warning—Potential Damage:** To prevent damage from electrostatic discharge, touch any exposed metal frame of the printer before accessing or touching interior areas of the printer.

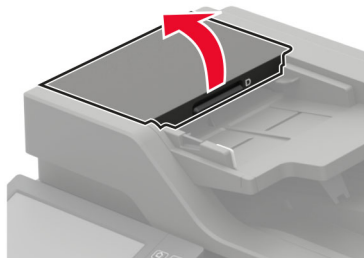

- 3 Remove the jammed paper.

**Note:** Make sure that all paper fragments are removed.

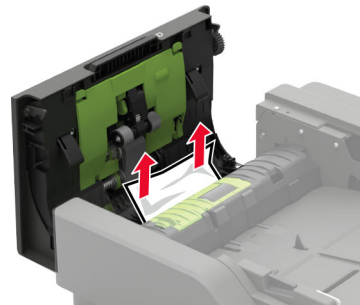

- 4 Close door D.

5 Open the scanner cover.



6 Open door E.

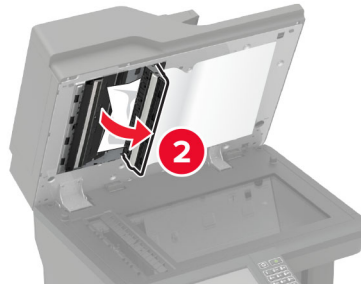
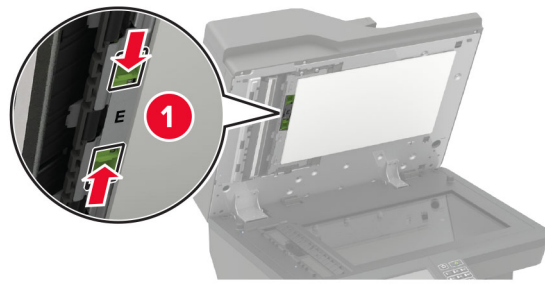

7 Remove the jammed paper.

**Note:** Make sure that all paper fragments are removed.

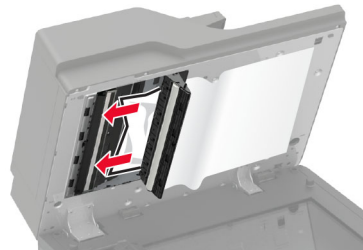

8 Close door E, and then close the scanner cover.

## Paper jam in the 4-bin mailbox

### Paper jam in door N

- 1 Open door N.

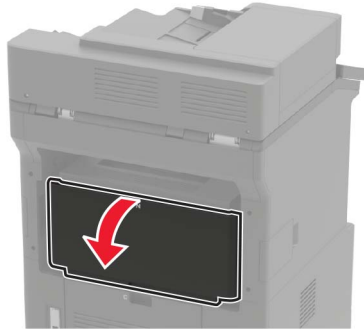

- 2 Remove the jammed paper.

**Note:** Make sure that all paper fragments are removed.



- 3 Close the door.

### Paper jam in the mailbox bin

Remove the jammed paper.

**Note:** Make sure that all paper fragments are removed.

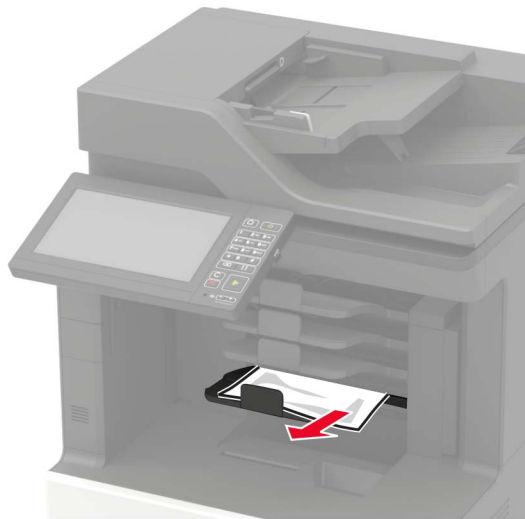

## Paper jam in the offset stacker or staple finisher

### Paper jam in door H

- 1 Open door H.

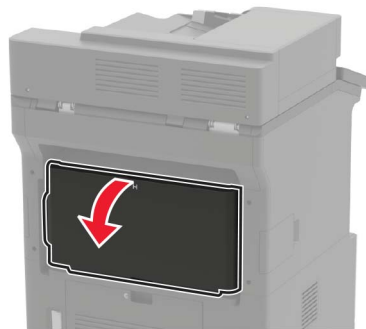

- 2 Remove the jammed paper.

**Note:** Make sure that all paper fragments are removed.

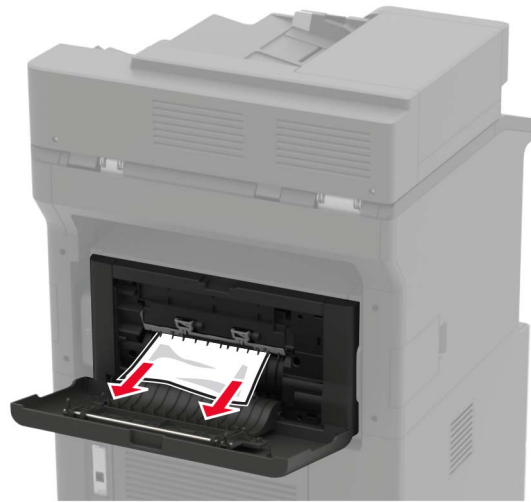

**3** Close the door.

### **Paper jam in the offset stacker or staple finisher bin**

Remove the jammed paper.

**Note:** Make sure that all paper fragments are removed.



Paper jam in the staple, hole punch finisher

## Paper jam in the staple, hole punch finisher

### Paper jam in door P

- 1 Open door P.

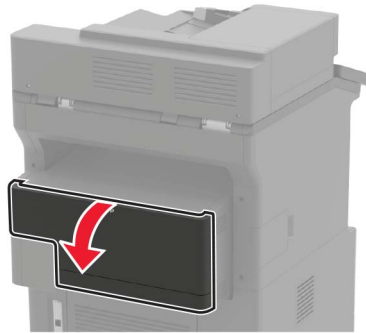

- 2 Remove the jammed paper.

**Note:** Make sure that all paper fragments are removed.

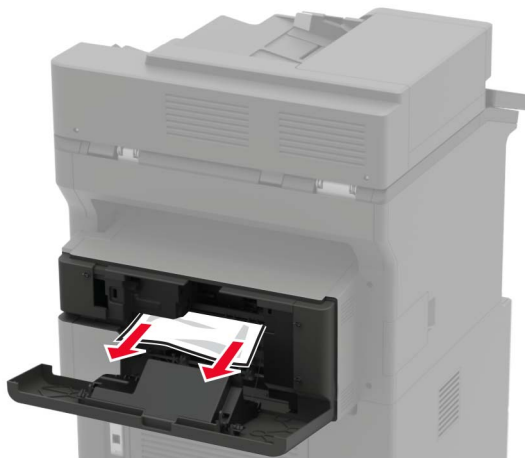

- 3 Close the door.

### Paper jam in the staple, hole punch finisher bin

Remove the jammed paper.

**Note:** Make sure that all paper fragments are removed.



## Staple jam in the staple finisher

- 1 Open door F.



**2** Remove the staple cartridge holder.

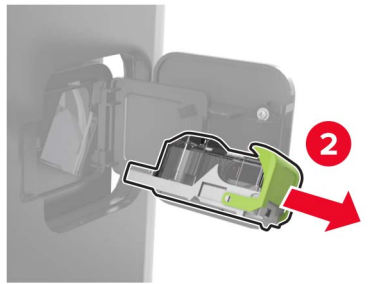
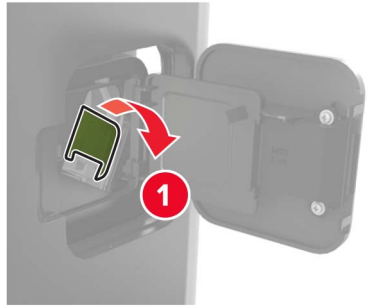

**3** Remove the loose staples.

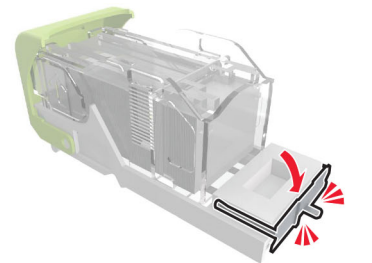
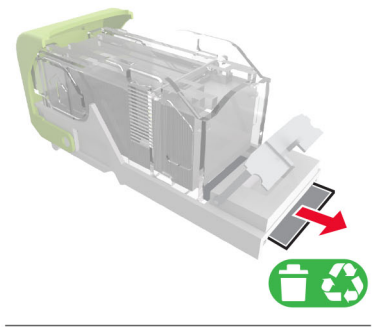
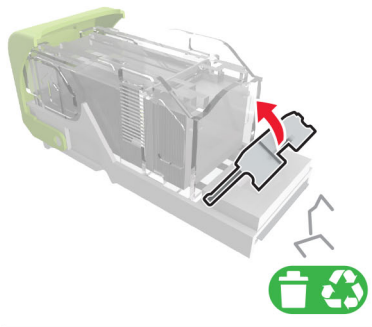



- 4 Press the staples against the metal bracket.



**Note:** If the staples are at the rear of the cartridge, then shake the cartridge downward to bring the staples near the metal bracket.

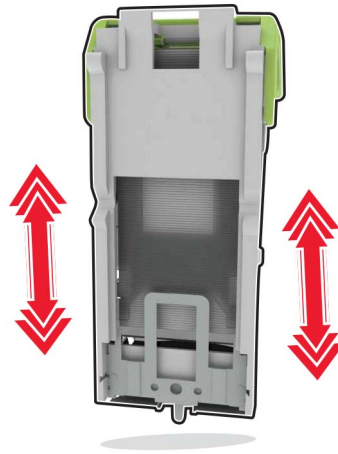

- 5 Insert the staple cartridge holder until it *clicks* into place.

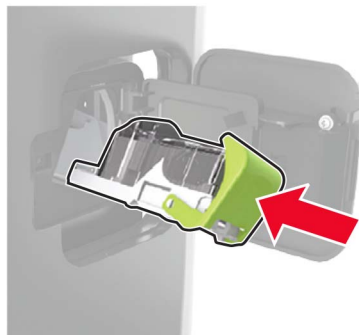

- 6 Close the door.

## Staple jam in the staple, hole punch finisher

1 Depending on the staple jam location, open either door F or door G.

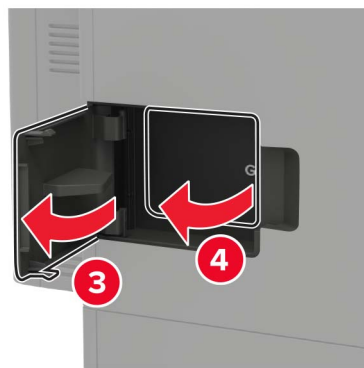
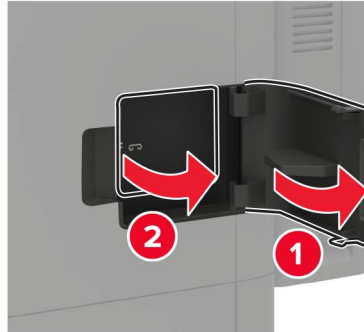

2 Remove the staple cartridge holder.

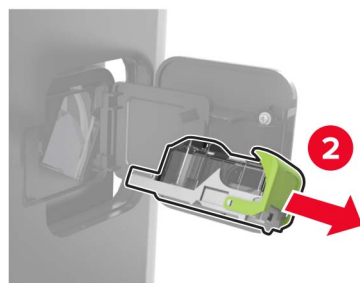
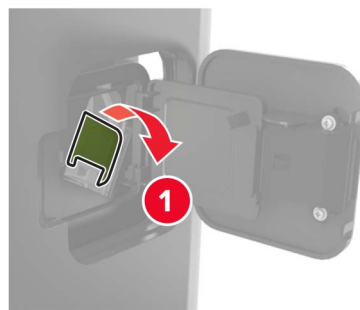

3 Remove the loose staples.

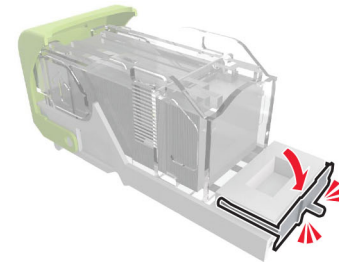
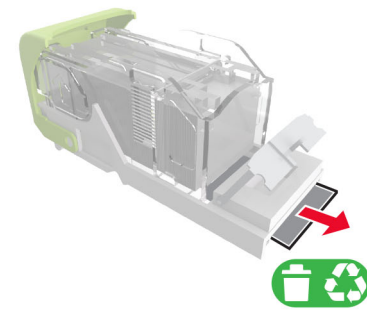
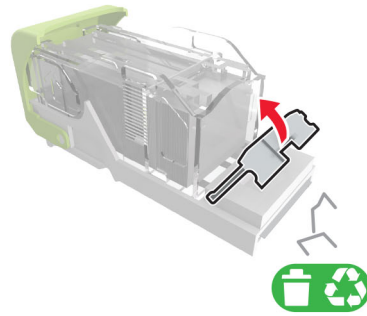

4 Press the staples against the metal bracket.



**Note:** If the staples are at the rear of the cartridge, then shake the cartridge downward to bring the staples near the metal bracket.

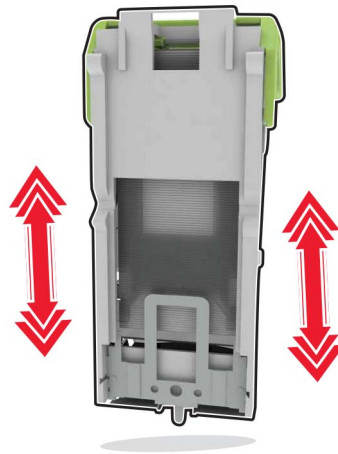

**5** Insert the staple cartridge holder until it *clicks* into place.

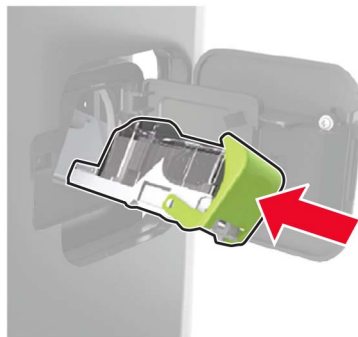

**6** Close the door.

# Troubleshooting

## Print quality problems

Find the image that resembles the print quality problem you are having, and then click the link below it to read problem-solving steps.

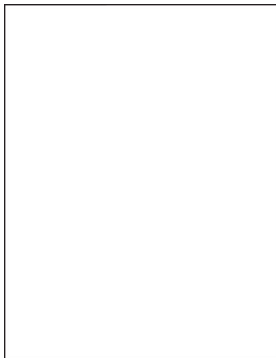

[“Blank or white pages” on page 242](#)

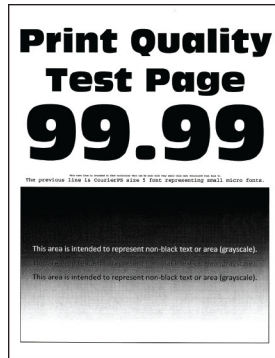

[“Dark print” on page 244](#)

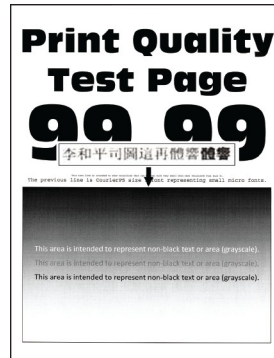

[“Fine lines are not printed correctly” on page 245](#)



[“Folded or wrinkled paper” on page 246](#)

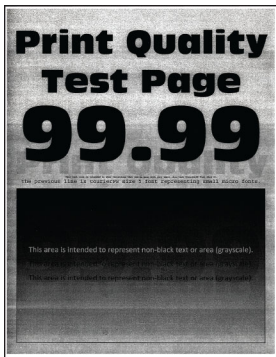

[“Gray background” on page 247](#)



[“Horizontal light bands” on page 259](#)



[“Incorrect margins” on page 249](#)

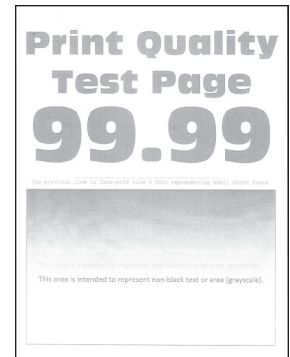

[“Light print” on page 250](#)



[“Mottled print and dots” on page 252](#)



[“Paper curl” on page 280](#)

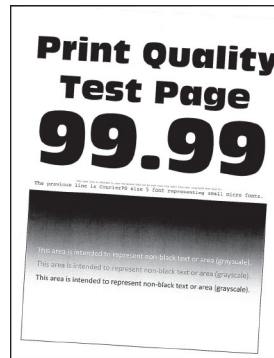

[“Print crooked or skewed” on page 253](#)



[“Repeating defects” on page 266](#)

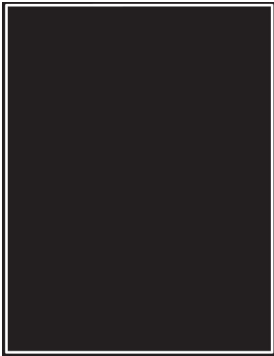

[“Solid black pages” on page 253](#)



[“Text or images cut off” on page 255](#)



[“Toner easily rubs off” on page 258](#)

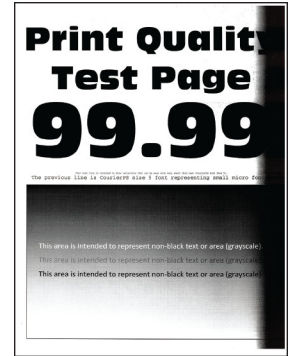

[“Vertical dark bands” on page 261](#)



[“Vertical dark lines or streaks” on page 264](#)

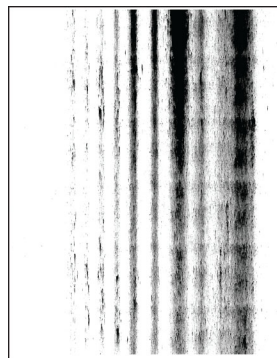

[“Vertical dark streaks with print missing” on page 265](#)



[“Vertical light bands” on page 259](#)

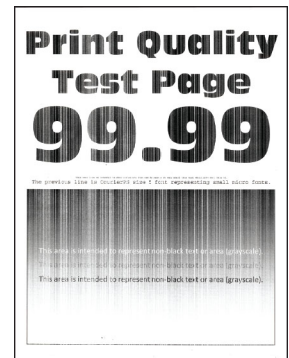

[“Vertical white lines” on page 260](#)

## Printing problems

### Print quality is poor

#### Blank or white pages



**Note:** Before solving the problem, print the Print Quality Test Pages. From the control panel, navigate to **Settings > Troubleshooting > Print Quality Test Pages**. For non-touch-screen printer models, press  to navigate through the settings.

Action	Yes	No
<p><b>Step 1</b></p> <p><b>a</b> Check if the printer is using a genuine and supported Lexmark toner cartridge.</p> <p><b>Note:</b> If the cartridge is not supported, then install a supported one.</p> <p><b>b</b> Print the document.</p> <p>Is the printer printing blank or white pages?</p>	Go to step 2.	The problem is solved.
<p><b>Step 2</b></p> <p><b>a</b> Remove any packing material that is left on the imaging unit.</p> <p><b>1</b> Remove the toner cartridge, and then remove the imaging unit.</p> <p><b>Warning—Potential Damage:</b> Do not expose the imaging unit to direct light for more than 10 minutes. Extended exposure to light may cause print quality problems.</p> <p><b>Warning—Potential Damage:</b> Do not touch the photoconductor drum under the imaging unit. Doing so may affect the quality of future print jobs.</p> <p><b>2</b> Check the imaging unit for signs of damage.</p> <p><b>Note:</b> Make sure that the photoconductor drum contact is not bent or out of place.</p> <p><b>3</b> Firmly shake the imaging unit to redistribute the toner.</p> <p><b>4</b> Insert the imaging unit, and then insert the toner cartridge.</p> <p><b>b</b> Print the document.</p> <p>Is the printer printing blank or white pages?</p>	Go to step 3.	The problem is solved.
<p><b>Step 3</b></p> <p>Check the transfer roller for proper installation.</p> <p>Is the transfer roller installed properly?</p>	Go to step 5.	Go to step 4.
<p><b>Step 4</b></p> <p><b>a</b> Remove, and then insert the transfer roller.</p> <p><b>b</b> Print the document.</p> <p>Is the printer printing blank or white pages?</p>	Go to step 5.	The problem is solved.
<p><b>Step 5</b></p> <p><b>a</b> Replace the imaging unit.</p> <p><b>b</b> Print the document.</p> <p>Is the printer printing blank or white pages?</p>	Contact <a href="#">customer support</a> .	The problem is solved.

## Dark print

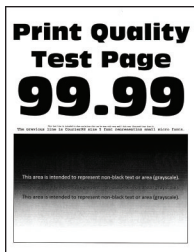

**Note:** Before solving the problem, print the Print Quality Test Pages. From the control panel, navigate to **Settings > Troubleshooting > Print Quality Test Pages**. For non-touch-screen printer models, press  to navigate through the settings.

Action	Yes	No
<p><b>Step 1</b></p> <p><b>a</b> Check if the printer is using a genuine and supported Lexmark toner cartridge.</p> <p><b>Note:</b> If the cartridge is not supported, then install a supported one.</p> <p><b>b</b> Print the document.</p> <p>Is the print dark?</p>	Go to step 2.	The problem is solved.
<p><b>Step 2</b></p> <p><b>a</b> Turn off the printer, wait for about 10 seconds, and then turn on the printer.</p> <p><b>b</b> Reduce toner darkness.</p> <p>From the control panel, navigate to:</p> <p><b>Settings &gt; Print &gt; Quality &gt; Toner Darkness</b></p> <p><b>c</b> Print the document.</p> <p>Is the print dark?</p>	Go to step 3.	The problem is solved.
<p><b>Step 3</b></p> <p><b>a</b> Depending on your operating system, specify the paper type from the Printing Preferences or Print dialog.</p> <p><b>Notes:</b></p> <ul style="list-style-type: none"> <li>• Make sure that the setting matches the paper loaded.</li> <li>• You can also change the setting on the printer control panel. Navigate to <b>Settings &gt; Paper &gt; Tray Configuration &gt; Paper Size/Type</b>.</li> </ul> <p><b>b</b> Print the document.</p> <p>Is the print dark?</p>	Go to step 4.	The problem is solved.



Action	Yes	No
<p><b>Step 4</b> Check if the paper has texture or rough finishes.</p> <p>Are you printing on textured or rough paper?</p>	Go to step 5.	Go to step 6.
<p><b>Step 5</b>  <b>a</b> Replace textured paper with plain paper.  <b>b</b> Print the document.</p> <p>Is the print dark?</p>	Go to step 6.	The problem is solved.
<p><b>Step 6</b>  <b>a</b> Load paper from a fresh package.  <b>Note:</b> Paper absorbs moisture due to high humidity. Store paper in its original wrapper until you are ready to use it.  <b>b</b> Print the document.</p> <p>Is the print dark?</p>	Go to step 7.	The problem is solved.
<p><b>Step 7</b>  <b>a</b> Remove, and then insert the imaging unit.  <b>Warning—Potential Damage:</b> Do not expose the imaging unit to direct light for more than 10 minutes. Extended exposure to light may cause print quality problems.  <b>Warning—Potential Damage:</b> Do not touch the photoconductor drum under the imaging unit. Doing so may affect the quality of future print jobs.  <b>b</b> Print the document.</p> <p>Is the print dark?</p>	Go to step 8.	The problem is solved.
<p><b>Step 8</b>  <b>a</b> Replace the imaging unit.  <b>b</b> Print the document.</p> <p>Is the print dark?</p>	Contact <a href="#">customer support</a> .	The problem is solved.

**Fine lines are not printed correctly**



**Note:** Before solving the problem, print the Print Quality Test Pages. From the control panel, navigate to **Settings > Troubleshooting > Print Quality Test Pages**. For non-touch-screen printer models, press  to navigate through the settings.

Action	Yes	No
<p><b>Step 1</b></p> <p><b>a</b> Check if the printer is using a genuine and supported Lexmark toner cartridge.</p> <p><b>Note:</b> If the cartridge is not supported, then install a supported one.</p> <p><b>b</b> Print the document.</p> <p>Are fine lines not printed correctly?</p>	Go to step 2.	The problem is solved.
<p><b>Step 2</b></p> <p><b>a</b> Adjust the print quality settings.</p> <p><b>1</b> From the control panel, navigate to: <b>Settings &gt; Print &gt; Quality &gt; Pixel Boost &gt; Fonts</b></p> <p><b>2</b> Adjust Toner Darkness to 7. From the control panel, navigate to: <b>Settings &gt; Print &gt; Quality</b></p> <p><b>b</b> Print the document.</p> <p>Are fine lines not printed correctly?</p>	Contact <a href="#">customer support</a> .	The problem is solved.

### Folded or wrinkled paper



**Note:** Before solving the problem, print the Print Quality Test Pages. From the control panel, navigate to **Settings > Troubleshooting > Print Quality Test Pages**. For non-touch-screen printer models, press  to navigate through the settings.

Action	Yes	No
<p><b>Step 1</b></p> <p><b>a</b> Check if the printer is using a genuine and supported Lexmark toner cartridge.</p> <p><b>Note:</b> If the cartridge is not supported, then install a supported one.</p> <p><b>b</b> Print the document.</p> <p>Is the paper folded or wrinkled?</p>	Go to step 2.	The problem is solved.
<p><b>Step 2</b></p> <p><b>a</b> Load paper from a fresh package.</p> <p><b>Note:</b> Paper absorbs moisture due to high humidity. Store paper in its original wrapper until you are ready to use it.</p> <p><b>b</b> Print the document.</p> <p>Is the paper folded or wrinkled?</p>	Go to step 3.	The problem is solved.
<p><b>Step 3</b></p> <p><b>a</b> Depending on your operating system, specify the paper type from the Printing Preferences or Print dialog.</p> <p><b>Notes:</b></p> <ul style="list-style-type: none"> <li>• Make sure that the setting matches the paper loaded.</li> <li>• You can also change the setting from the printer control panel. Navigate to <b>Settings &gt; Paper &gt; Tray Configuration &gt; Paper Size/Type</b>.</li> </ul> <p><b>b</b> Print the document.</p> <p>Is the paper folded or wrinkled?</p>	Contact <a href="#">customer support</a> .	The problem is solved.

**Gray background**



**Note:** Before solving the problem, print the Print Quality Test Pages. From the control panel, navigate to **Settings > Troubleshooting > Print Quality Test Pages**.

Action	Yes	No
<p><b>Step 1</b></p> <p><b>a</b> Turn off the printer, wait for 10 seconds, and then turn on the printer.</p> <p><b>b</b> Decrease toner darkness. From the control panel, navigate to <b>Settings &gt; Print &gt; Quality &gt; Toner Darkness</b>.</p> <p><b>c</b> Print the document.</p> <p>Does gray background appear on prints?</p>	<p>Go to step 2.</p>	<p>The problem is solved.</p>
<p><b>Step 2</b></p> <p><b>a</b> Check if the printer is using a genuine and supported Lexmark toner cartridge. <b>Note:</b> If the cartridge is not supported, then install a supported one.</p> <p><b>b</b> Print the document.</p> <p>Does gray background appear on prints?</p>	<p>Go to step 3.</p>	<p>The problem is solved.</p>
<p><b>Step 3</b></p> <p><b>a</b> Depending on your operating system, specify the paper type from the Printing Preferences or Print dialog. <b>Notes:</b></p> <ul style="list-style-type: none"> <li>• Make sure that the setting matches the paper loaded.</li> <li>• You can also change the setting from the printer control panel. Navigate to <b>Settings &gt; Paper &gt; Tray Configuration &gt; Paper Size/Type</b>.</li> </ul> <p><b>b</b> Print the document.</p> <p>Does gray background appear on prints?</p>	<p>Go to step 4.</p>	<p>The problem is solved.</p>
<p><b>Step 4</b></p> <p><b>a</b> Remove, and then insert the imaging unit. <b>Warning—Potential Damage:</b> Do not expose the imaging unit to direct light. Extended exposure to light may cause print quality problems. <b>Warning—Potential Damage:</b> Do not touch the photoconductor drum. Doing so may affect the quality of future print jobs.</p> <p><b>b</b> Print the document.</p> <p>Does gray background appear on prints?</p>	<p>Go to step 5.</p>	<p>The problem is solved.</p>

Action	Yes	No
<p><b>Step 5</b></p> <p><b>a</b> Update the printer firmware. For more information, see the “Updating firmware” section.</p> <p><b>b</b> Print the document.</p> <p>Does gray background appear on prints?</p>	Go to step 6.	The problem is solved.
<p><b>Step 6</b></p> <p><b>a</b> Replace the imaging unit.</p> <p><b>b</b> Print the document.</p> <p>Does gray background appear on prints?</p>	Contact <a href="#">customer support</a> .	The problem is solved.

**Incorrect margins**



Action	Yes	No
<p><b>Step 1</b></p> <p><b>a</b> Adjust the paper guides to the correct position for the paper loaded.</p> <p><b>b</b> Print the document.</p> <p>Are the margins correct?</p>	The problem is solved.	Go to step 2.
<p><b>Step 2</b></p> <p><b>a</b> Set the paper size. From the control panel, navigate to: <b>Settings &gt; Paper &gt; Tray Configuration &gt; Paper Size/Type</b></p> <p><b>b</b> Print the document.</p> <p>Are the margins correct?</p>	The problem is solved.	Go to step 3.
<p><b>Step 3</b></p> <p><b>a</b> Depending on your operating system, specify the paper size from the Printing Preferences or Print dialog. <b>Note:</b> Make sure that the setting matches the paper loaded.</p> <p><b>b</b> Print the document.</p> <p>Are the margins correct?</p>	The problem is solved.	Contact <a href="#">customer support</a> .

## Light print

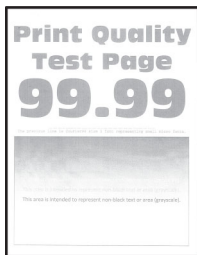

**Note:** Before solving the problem, print the Print Quality Test Pages. From the control panel, navigate to **Settings > Troubleshooting > Print Quality Test Pages**. For non-touch-screen printer models, press  to navigate through the settings.

Action	Yes	No
<p><b>Step 1</b></p> <p><b>a</b> Check if the printer is using a genuine and supported Lexmark toner cartridge.</p> <p><b>Note:</b> If the cartridge is not supported, then install a supported one.</p> <p><b>b</b> Print the document.</p> <p>Is the print light?</p>	Go to step 2.	The problem is solved.
<p><b>Step 2</b></p> <p><b>a</b> Turn off the printer, wait for about 10 seconds, and then turn on the printer.</p> <p><b>b</b> Increase toner darkness.</p> <p>From the control panel, navigate to:</p> <p><b>Settings &gt; Print &gt; Quality &gt; Toner Darkness</b></p> <p><b>c</b> Print the document.</p> <p>Is the print light?</p>	Go to step 3.	The problem is solved.
<p><b>Step 3</b></p> <p><b>a</b> Depending on your operating system, specify the paper type from the Printing Preferences or Print dialog.</p> <p><b>Notes:</b></p> <ul style="list-style-type: none"> <li>• Make sure that the setting matches the paper loaded.</li> <li>• You can also change the setting on the printer control panel. Navigate to <b>Settings &gt; Paper &gt; Tray Configuration &gt; Paper Size/Type</b>.</li> </ul> <p><b>b</b> Print the document.</p> <p>Is the print light?</p>	Go to step 4.	The problem is solved.

Action	Yes	No
<p><b>Step 4</b></p> <ul style="list-style-type: none"> <li><b>a</b> Depending on your operating system, specify the print resolution from the Printing Preferences or Print dialog.</li> <li><b>b</b> Set the resolution to <b>600 dpi</b>.</li> <li><b>c</b> Print the document.</li> </ul> <p>Is the print light?</p>	<p>Go to step 5.</p>	<p>The problem is solved.</p>
<p><b>Step 5</b></p> <ul style="list-style-type: none"> <li><b>a</b> Remove the imaging unit.</li> </ul> <p><b>Warning—Potential Damage:</b> Do not expose the imaging unit to direct light for more than 10 minutes. Extended exposure to light can cause print quality problems.</p> <p><b>Warning—Potential Damage:</b> Do not touch the photoconductor drum under the imaging unit. Doing so may affect the quality of future print jobs.</p> <ul style="list-style-type: none"> <li><b>b</b> Firmly shake the imaging unit to redistribute the toner.</li> <li><b>c</b> Insert the imaging unit.</li> <li><b>d</b> Turn off the printer, wait for 10 seconds, and then turn on the printer.</li> <li><b>e</b> Print the document.</li> </ul> <p>Is the print light?</p>	<p>Go to step 6.</p>	<p>The problem is solved.</p>
<p><b>Step 6</b></p> <ul style="list-style-type: none"> <li><b>a</b> Check the status of the toner cartridge.</li> </ul> <p>From the control panel, navigate to:</p> <p><b>Settings &gt; Reports &gt; Device &gt; Device Statistics</b></p> <ul style="list-style-type: none"> <li><b>b</b> From the Supply Information section of the pages printed, check the status of the toner cartridge.</li> </ul> <p>Is the toner cartridge near end of life?</p>	<p>Go to step 7.</p>	<p>Contact <a href="#">customer support</a>.</p>
<p><b>Step 7</b></p> <ul style="list-style-type: none"> <li><b>a</b> Replace the toner cartridge.</li> <li><b>b</b> Print the document.</li> </ul> <p>Is the print light?</p>	<p>Contact <a href="#">customer support</a>.</p>	<p>The problem is solved.</p>

### Mottled print and dots



**Note:** Before solving the problem, print the Print Quality Test Pages. From the control panel, navigate to **Settings > Troubleshooting > Print Quality Test Pages**. For non-touch-screen printer models, press  to navigate through the settings.

Action	Yes	No
<p><b>Step 1</b></p> <p><b>a</b> Check if the printer is using a genuine and supported Lexmark toner cartridge.</p> <p><b>Note:</b> If the cartridge is not supported, then install a supported one.</p> <p><b>b</b> Print the document.</p> <p>Is the print mottled?</p>	Go to step 2.	The problem is solved.
<p><b>Step 2</b></p> <p>Check the printer for leaked toner contamination.</p> <p>Is the printer free of leaked toner?</p>	Go to step 3.	Contact <a href="#">customer support</a> .
<p><b>Step 3</b></p> <p>Check the status of the imaging unit. From the control panel, navigate to:</p> <p><b>Status/Supplies &gt; Supplies</b></p> <p>Is the imaging unit near end of life?</p>	Go to step 4.	Contact <a href="#">customer support</a> .
<p><b>Step 4</b></p> <p><b>a</b> Replace the imaging unit.</p> <p><b>b</b> Print the document.</p> <p>Is the print mottled?</p>	Contact <a href="#">customer support</a> .	The problem is solved.



### Print crooked or skewed



**Note:** Before solving the problem, print the Print Quality Test Pages. From the home screen, touch **Settings** > **Troubleshooting** > **Print Quality Test Pages**.

Action	Yes	No
<p><b>Step 1</b></p> <ul style="list-style-type: none"> <li><b>a</b> Pull out the tray.</li> <li><b>b</b> Remove the paper, and then load paper from a fresh package. <b>Note:</b> Paper absorbs moisture due to high humidity. Store paper in its original wrapper until you are ready to use it.</li> <li><b>c</b> Squeeze and slide the paper guides to the correct position for the size of the paper you are loading.</li> <li><b>d</b> Insert the tray.</li> <li><b>e</b> Print the document.</li> </ul> <p>Is the print crooked or skewed?</p>	Go to step 2.	The problem is solved.
<p><b>Step 2</b></p> <ul style="list-style-type: none"> <li><b>a</b> Check if you are printing on a supported paper.</li> <li><b>b</b> Print the document.</li> </ul> <p>Is the print crooked or skewed?</p>	Contact <a href="#">customer support</a> .	The problem is solved.

### Solid black pages

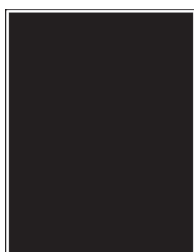

**Note:** Before solving the problem, print the Print Quality Test Pages. From the control panel, navigate to **Settings** > **Troubleshooting** > **Print Quality Test Pages**. For non-touch-screen printer models, press  to navigate through the settings.

Action	Yes	No
<p><b>Step 1</b></p> <p><b>a</b> Check if the printer is using a genuine and supported Lexmark toner cartridge.</p> <p><b>Note:</b> If the toner cartridge is not supported, then install a supported one.</p> <p><b>b</b> Print the document.</p> <p>Is the printer printing solid black pages?</p>	<p>Go to step 2.</p>	<p>The problem is solved.</p>
<p><b>Step 2</b></p> <p><b>a</b> Remove, and then insert the imaging unit.</p> <p><b>Warning—Potential Damage:</b> Do not expose the imaging unit to direct light for more than 10 minutes. Extended exposure to light may cause print quality problems.</p> <p><b>Warning—Potential Damage:</b> Do not touch the photoconductor drum under the imaging unit. Doing so may affect the quality of future print jobs.</p> <p><b>b</b> Print the document.</p> <p>Is the printer printing solid black pages?</p>	<p>Go to step 3.</p>	<p>The problem is solved.</p>

Action	Yes	No
<p><b>Step 3</b></p> <p><b>a</b> Remove the imaging unit.</p> <p><b>Warning—Potential Damage:</b> Do not expose the imaging unit to direct light for more than 10 minutes. Extended exposure to light may cause print quality problems.</p> <p><b>Warning—Potential Damage:</b> Do not touch the photoconductor drum under the imaging unit. Doing so may affect the quality of future print jobs.</p> <p><b>b</b> Remove any packing material that is stuck on the imaging unit.</p> <div data-bbox="402 625 781 1178" style="text-align: center;"> </div> <p><b>Note:</b> Make sure to remove any obstruction between the charge roller and photoconductor drum.</p> <p><b>c</b> Insert the imaging unit.</p> <p><b>d</b> Print the document.</p> <p>Is the printer printing solid black pages?</p>	<p>Go to step 4.</p>	<p>The problem is solved.</p>
<p><b>Step 4</b></p> <p>Check the imaging unit for signs of damage.</p> <p>Is the imaging unit free from damage?</p>	<p>Contact <a href="#">customer support</a>.</p>	<p>Go to step 5.</p>
<p><b>Step 5</b></p> <p><b>a</b> Replace the imaging unit.</p> <p><b>b</b> Print the document.</p> <p>Is the printer printing solid black pages?</p>	<p>Contact <a href="#">customer support</a>.</p>	<p>The problem is solved.</p>

### Text or images cut off



**Note:** Before solving the problem, print the Print Quality Test Pages. From the control panel, navigate to **Settings > Troubleshooting > Print Quality Test Pages**. For non-touch-screen printer models, press  to navigate through the settings.

Action	Yes	No
<p><b>Step 1</b></p> <p><b>a</b> Check if the printer is using a genuine and supported Lexmark toner cartridge.</p> <p><b>Note:</b> If the toner cartridge is not supported, then install a supported one.</p> <p><b>b</b> Print the document.</p> <p>Are text or images cut off?</p>	Go to step 2.	The problem is solved.
<p><b>Step 2</b></p> <p><b>a</b> Remove, and then insert the imaging unit.</p> <p><b>Warning—Potential Damage:</b> Do not expose the imaging unit to direct light for more than 10 minutes. Extended exposure to light may cause print quality problems.</p> <p><b>Warning—Potential Damage:</b> Do not touch the photoconductor drum under the imaging unit. Doing so may affect the quality of future print jobs.</p> <p><b>b</b> Print the document.</p> <p>Are text or images cut off?</p>	Go to step 3.	The problem is solved.

Action	Yes	No
<p><b>Step 3</b></p> <p><b>a</b> Remove the imaging unit.</p> <p><b>Warning—Potential Damage:</b> Do not expose the imaging unit to direct light for more than 10 minutes. Extended exposure to light may cause print quality problems.</p> <p><b>Warning—Potential Damage:</b> Do not touch the photoconductor drum under the imaging unit. Doing so may affect the quality of future print jobs.</p> <p><b>b</b> Remove any packing material that is stuck on the imaging unit.</p> <div data-bbox="402 625 779 1186" style="text-align: center;"> </div> <p><b>Note:</b> Make sure to remove any obstruction between the charge roller and photoconductor drum.</p> <p><b>c</b> Insert the imaging unit.</p> <p><b>d</b> Print the document.</p> <p>Are text or images cut off?</p>	<p>Go to step 4.</p>	<p>The problem is solved.</p>
<p><b>Step 4</b></p> <p><b>a</b> Replace the imaging unit.</p> <p><b>b</b> Print the document.</p> <p>Are text or images cut off?</p>	<p>Contact <a href="#">customer support</a>.</p>	<p>The problem is solved.</p>

### Toner easily rubs off



**Note:** Before solving the problem, print the Print Quality Test Pages. From the control panel, navigate to **Settings > Troubleshooting > Print Quality Test Pages**. For non-touch-screen printer models, press  to navigate through the settings.

Action	Yes	No
<p><b>Step 1</b></p> <p><b>a</b> Check if the printer is using a genuine and supported Lexmark toner cartridge.</p> <p><b>Note:</b> If the cartridge is not supported, then install a supported one.</p> <p><b>b</b> Print the document.</p> <p>Does toner easily rub off?</p>	Go to step 2.	The problem is solved.
<p><b>Step 2</b></p> <p><b>a</b> Depending on your operating system, specify the paper type from the Printing Preferences or Print dialog.</p> <p><b>Notes:</b></p> <ul style="list-style-type: none"> <li>• Make sure that the setting matches the paper loaded.</li> <li>• You can also change the setting on the printer control panel.</li> </ul> <p><b>b</b> Print the document.</p> <p>Does toner easily rub off?</p>	Go to step 3.	The problem is solved.
<p><b>Step 3</b></p> <p><b>a</b> Remove, and then insert the fuser.</p> <p><b>b</b> Print the document.</p> <p>Does toner easily rub off?</p>	Contact <a href="#">customer support</a> .	The problem is solved.

### Horizontal light bands



**Note:** Before solving the problem, print the Print Quality Test Pages. From the control panel, navigate to **Settings > Troubleshooting > Print Quality Test Pages**. For non-touch-screen printer models, press  to navigate through the settings.

Action	Yes	No
<p><b>Step 1</b></p> <p><b>a</b> Check if the printer is using a genuine and supported Lexmark toner cartridge.</p> <p><b>Note:</b> If the cartridge is not supported, then install a supported one.</p> <p><b>b</b> Print the document.</p> <p>Do horizontal light bands appear on prints?</p>	Go to step 2.	The problem is solved.
<p><b>Step 2</b></p> <p><b>a</b> Turn off the printer, wait for about 10 seconds, and then turn on the printer.</p> <p><b>b</b> Print the document.</p> <p>Do horizontal light bands appear on prints?</p>	Contact <a href="#">customer support</a> .	The problem is solved.

### Vertical light bands



**Note:** Before solving the problem, print the Print Quality Test Pages. From the control panel, navigate to **Settings > Troubleshooting > Print Quality Test Pages**. For non-touch-screen printer models, press  to navigate through the settings.

Action	Yes	No
<p><b>a</b> Check if the printer is using a genuine and supported Lexmark toner cartridge.</p> <p><b>Note:</b> If the cartridge is not supported, then install a supported one.</p> <p><b>b</b> Print the document.</p> <p>Do vertical light bands appear on prints?</p>	Contact <a href="#">customer support</a> .	The problem is solved.

### Vertical white lines





**Note:** Before solving the problem, print the Print Quality Test Pages. From the control panel, navigate to **Settings > Troubleshooting > Print Quality Test Pages**. For non-touch-screen printer models, press  to navigate through the settings.

Action	Yes	No
<p><b>Step 1</b></p> <p><b>a</b> Check if the printer is using a genuine and supported Lexmark toner cartridge.</p> <p><b>Note:</b> If the cartridge is not supported, then install a supported one.</p> <p><b>b</b> Print the document.</p> <p>Do vertical white lines appear on prints?</p>	Go to step 2.	The problem is solved.
<p><b>Step 2</b></p> <p>Fix slow printing problems. For more information, see <a href="#">“Slow printing” on page 268</a>.</p> <p>Do vertical white lines appear on prints?</p>	Go to step 3.	The problem is solved.
<p><b>Step 3</b></p> <p><b>a</b> Replace the imaging unit.</p> <p><b>b</b> Print the document.</p> <p>Do vertical white lines appear on prints?</p>	Contact <a href="#">customer support</a> .	The problem is solved.

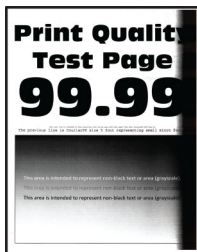

## Vertical dark bands



**Note:** Before solving the problem, print the Print Quality Test Pages. From the control panel, navigate to **Settings > Troubleshooting > Print Quality Test Pages**. For non-touch-screen printer models, press  to navigate through the settings.

Action	Yes	No
<p><b>Step 1</b></p> <p><b>a</b> Check if the printer is using a genuine and supported Lexmark toner cartridge.</p> <p><b>Note:</b> If the toner cartridge is not supported, then install a supported one.</p> <p><b>b</b> Print the document.</p> <p>Do vertical dark bands appear on prints?</p>	Go to step 2.	The problem is solved.
<p><b>Step 2</b></p> <p><b>a</b> Remove the toner cartridge, and then remove the imaging unit.</p> <p><b>Warning—Potential Damage:</b> Do not expose the imaging unit to direct light for more than 10 minutes. Extended exposure to light may cause print quality problems.</p> <p><b>Warning—Potential Damage:</b> Do not touch the photoconductor drum under the imaging unit. Doing so may affect the quality of future print jobs.</p> <p><b>b</b> Insert the imaging unit, and then insert the cartridge.</p> <p><b>c</b> Print the document.</p> <p>Do vertical dark bands appear on prints?</p>	Go to step 3.	The problem is solved.

Action	Yes	No
<p><b>Step 3</b></p> <p><b>a</b> Remove the imaging unit.</p> <p><b>Warning—Potential Damage:</b> Do not expose the imaging unit to direct light for more than 10 minutes. Extended exposure to light may cause print quality problems.</p> <p><b>Warning—Potential Damage:</b> Do not touch the photoconductor drum under the imaging unit. Doing so may affect the quality of future print jobs.</p> <p><b>b</b> Remove any packing material that is stuck on the imaging unit.</p> <div data-bbox="402 625 781 1178" style="text-align: center;"> </div> <p><b>Note:</b> Make sure to remove any obstruction between the charge roller and photoconductor drum.</p> <p><b>c</b> Insert the imaging unit.</p> <p><b>d</b> Print the document.</p> <p>Do vertical dark bands appear on prints?</p>	<p>Go to step 4.</p>	<p>The problem is solved.</p>
<p><b>Step 4</b></p> <p><b>a</b> Check if a bright light enters the right side of the printer, and move the printer if necessary.</p> <p><b>b</b> Print the document.</p> <p>Do vertical dark bands appear on prints?</p>	<p>Contact <a href="#">customer support</a>.</p>	<p>The problem is solved.</p>

### Vertical dark lines

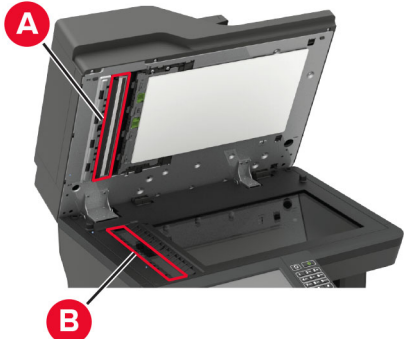
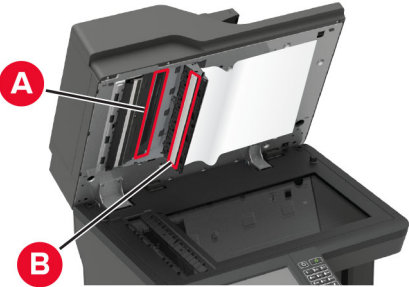

**Note:** Before solving the problem, print the Print Quality Test Pages. From the control panel, navigate to **Settings > Troubleshooting > Print Quality Test Pages**. For non-touch-screen printer models, press  to navigate through the settings.

Action	Yes	No
<p><b>Step 1</b></p> <p>Using a blank sheet of paper, make a two-sided copy using the ADF.</p> <p>Do vertical dark lines or streaks appear on prints?</p>	Go to step 2.	Go to step 3.
<p><b>Step 2</b></p> <p>Using a damp, soft, lint-free cloth, wipe the following areas:</p> <ul style="list-style-type: none"> <li>• ADF glass pad (A) and ADF glass (B)</li> </ul>  <ul style="list-style-type: none"> <li>• ADF glass (A) and ADF glass pad (B) in door E</li> </ul>  <p>Do vertical dark lines or streaks appear on prints?</p>	Go to step 3.	The problem is solved.

Action	Yes	No
<p><b>Step 3</b></p> <p><b>a</b> Depending on your operating system, specify the paper type from the Printing Preferences or Print dialog.</p> <p><b>Notes:</b></p> <ul style="list-style-type: none"> <li>• Make sure that the setting matches the paper loaded.</li> <li>• You can also change the setting on the printer control panel. Navigate to <b>Settings &gt; Paper &gt; Tray Configuration &gt; Paper Size/Type</b>.</li> </ul> <p><b>b</b> Print the document.</p> <p>Do vertical dark lines or streaks appear on prints?</p>	Go to step 4.	The problem is solved.
<p><b>Step 4</b></p> <p><b>a</b> Load paper from a fresh package.</p> <p><b>Note:</b> Paper absorbs moisture due to high humidity. Store paper in its original wrapper until you use it.</p> <p><b>b</b> Print the document.</p> <p>Do vertical dark lines or streaks appear on prints?</p>	Go to step 5.	The problem is solved.
<p><b>Step 5</b></p> <p><b>a</b> Remove, and then insert the imaging kit.</p> <p><b>Warning—Potential Damage:</b> Do not expose the imaging kit to direct light. Extended exposure to light can cause print quality problems.</p> <p><b>Warning—Potential Damage:</b> Do not touch the photoconductor drum under the imaging kit. Doing so may affect the quality of future print jobs.</p> <p><b>b</b> Print the document.</p> <p>Do vertical dark lines or streaks appear on prints?</p>	Contact <a href="#">customer support</a> .	The problem is solved.

**Vertical dark lines or streaks**



**Note:** Before solving the problem, print the Print Quality Test Pages. From the control panel, navigate to **Settings > Troubleshooting > Print Quality Test Pages**. For non-touch-screen printer models, press  to navigate through the settings.

Action	Yes	No
<p><b>Step 1</b></p> <p><b>a</b> Check if the printer is using a genuine and supported Lexmark toner cartridge.</p> <p><b>Note:</b> If the toner cartridge is not supported, then install a supported one.</p> <p><b>b</b> Print the document.</p> <p>Do vertical dark lines or streaks appear on prints?</p>	Go to step 2.	The problem is solved.
<p><b>Step 2</b></p> <p><b>a</b> Remove, and then reinstall the imaging unit.</p> <p><b>Warning—Potential Damage:</b> Do not expose the imaging unit to direct light for more than 10 minutes. Extended exposure to light can cause print quality problems.</p> <p><b>Warning—Potential Damage:</b> Do not touch the photoconductor drum under the imaging unit. Doing so may affect the quality of future print jobs.</p> <p><b>b</b> Print the document.</p> <p>Do vertical dark lines or streaks appear on prints?</p>	Go to step 3.	The problem is solved.
<p><b>Step 3</b></p> <p><b>a</b> Replace the imaging unit.</p> <p><b>b</b> Print the document.</p> <p>Do vertical dark lines or streaks appear on prints?</p>	Contact <a href="#">customer support</a> .	The problem is solved.

### Vertical dark streaks with print missing

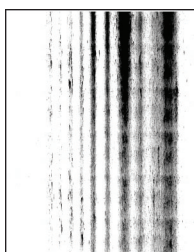

**Note:** Before solving the problem, print the Print Quality Test Pages. From the control panel, navigate to **Settings > Troubleshooting > Print Quality Test Pages**. For non-touch-screen printer models, press  to navigate through the settings.

Action	Yes	No
<p><b>Step 1</b></p> <p><b>a</b> Remove the imaging unit.</p> <p><b>Warning—Potential Damage:</b> Do not expose the imaging unit to direct light for more than 10 minutes. Extended exposure to light may cause print quality problems.</p> <p><b>Warning—Potential Damage:</b> Do not touch the photoconductor drum under the imaging unit. Doing so may affect the quality of future print jobs.</p> <p><b>b</b> Remove any packing material that is stuck on the imaging unit.</p> <div data-bbox="402 646 776 1163" style="text-align: center;"> </div> <p><b>Note:</b> Make sure to remove any obstruction between the charge roller and photoconductor drum.</p> <p><b>c</b> Insert the imaging unit.</p> <p><b>d</b> Print the document.</p> <p>Do vertical dark streaks with missing images appear on prints?</p>	<p>Go to step 2.</p>	<p>The problem is solved.</p>
<p><b>Step 2</b></p> <p><b>a</b> Check if the printer is using a genuine and supported Lexmark toner cartridge.</p> <p><b>Note:</b> If the toner cartridge is not supported, then install a supported one.</p> <p><b>b</b> Print the document.</p> <p>Do vertical dark streaks with missing images appear on prints?</p>	<p>Contact <a href="#">customer support</a>.</p>	<p>The problem is solved.</p>

### Repeating defects



**Note:** Before solving the problem, print the Print Quality Test Pages. From the control panel, navigate to **Settings > Troubleshooting > Print Quality Test Pages**. For non-touch-screen printer models, press  to navigate through the settings.

Action	Yes	No
<p><b>Step 1</b></p> <p>Using the Print Quality Test Pages, check if the distance between the repeating defects is equal to any of the following:</p> <ul style="list-style-type: none"> <li>• 96 mm (3.78 in.)</li> <li>• 49 mm (1.93 in.)</li> <li>• 47.5 mm (1.87 in.)</li> <li>• 30.2 mm (1.18 in.)</li> </ul> <p>Does the distance between the repeating defects match any of the measurements?</p>	Go to step 2.	Take note of the distance, and then contact <a href="#">customer support</a> .
<p><b>Step 2</b></p> <p><b>a</b> Replace the imaging unit.</p> <p><b>b</b> Print the document.</p> <p>Do the repeating defects appear?</p>	Contact <a href="#">customer support</a> .	The problem is solved.

### Print jobs do not print

Action	Yes	No
<p><b>Step 1</b></p> <p><b>a</b> From the document you are trying to print, open the Print dialog, and then check if you have selected the correct printer.</p> <p><b>b</b> Print the document.</p> <p>Is the document printed?</p>	The problem is solved.	Go to step 2.

Action	Yes	No
<p><b>Step 2</b></p> <p><b>a</b> Check if the printer is on.</p> <p><b>b</b> Resolve any error messages that appear on the display.</p> <p><b>c</b> Print the document.</p> <p>Is the document printed?</p>	The problem is solved.	Go to step 3.
<p><b>Step 3</b></p> <p><b>a</b> Check if the ports are working and if the cables are securely connected to the computer and the printer.</p> <p>For more information, see the setup documentation that came with the printer.</p> <p><b>b</b> Print the document.</p> <p>Is the document printed?</p>	The problem is solved.	Go to step 4.
<p><b>Step 4</b></p> <p><b>a</b> Turn off the printer, wait for about 10 seconds, and then turn on the printer.</p> <p><b>b</b> Print the document.</p> <p>Is the document printed?</p>	The problem is solved.	Go to step 5.
<p><b>Step 5</b></p> <p><b>a</b> Remove, and then reinstall the print driver.</p> <p><b>b</b> Print the document.</p> <p>Is the document printed?</p>	The problem is solved.	Contact <a href="#">customer support</a> .

## Slow printing

Action	Yes	No
<p><b>Step 1</b></p> <p>Make sure that the printer cable is securely connected to the printer and to the computer, print server, option, or other network device.</p> <p>Is the printer printing slow?</p>	Go to step 2.	The problem is solved.
<p><b>Step 2</b></p> <p><b>a</b> Make sure that the printer is not in Quiet Mode.</p> <p>From the home screen, touch <b>Settings &gt; Device &gt; Maintenance &gt; Configuration Menu &gt; Device Operations &gt; Quiet Mode</b>.</p> <p><b>b</b> Print the document.</p> <p>Is the printer printing slow?</p>	Go to step 3.	The problem is solved.



Action	Yes	No
<p><b>Step 3</b></p> <p><b>a</b> Depending on your operating system, specify the print resolution from the Printing Preferences or Print dialog.</p> <p><b>b</b> Set the resolution to <b>600 dpi</b>.</p> <p><b>c</b> Print the document.</p> <p>Is the printer printing slow?</p>	Go to step 4.	The problem is solved.
<p><b>Step 4</b></p> <p><b>a</b> From the home screen, touch <b>Settings &gt; Print &gt; Quality &gt; Print Resolution</b>.</p> <p><b>b</b> Set the resolution to <b>600 dpi</b>.</p> <p><b>c</b> Print the document.</p> <p>Is the printer printing slow?</p>	Go to step 5.	The problem is solved.
<p><b>Step 5</b></p> <p><b>a</b> Depending on your operating system, specify the paper type from the Printing Preferences or Print dialog.</p> <p><b>Notes:</b></p> <ul style="list-style-type: none"> <li>• Make sure that the setting matches the paper loaded.</li> <li>• You can also change the setting on the printer control panel.</li> <li>• Heavier paper prints more slowly.</li> <li>• Paper narrower than letter, A4, and legal may print more slowly.</li> </ul> <p><b>b</b> Print the document.</p> <p>Is the printer printing slow?</p>	Go to step 6.	The problem is solved.
<p><b>Step 6</b></p> <p><b>a</b> Make sure that the printer settings for texture and weight match the paper being loaded.</p> <p>From the home screen, touch <b>Settings &gt; Paper &gt; Media Configuration &gt; Media Types</b>.</p> <p><b>Note:</b> Rough paper textures and heavy paper weights may print more slowly.</p> <p><b>b</b> Print the document.</p> <p>Is the printer printing slow?</p>	Go to step 7.	The problem is solved.
<p><b>Step 7</b></p> <p>Remove held jobs.</p> <p>Is the printer printing slow?</p>	Go to step 8.	The problem is solved.

Action	Yes	No
<p><b>Step 8</b></p> <p><b>a</b> Make sure that the printer is not overheating.</p> <p><b>Notes:</b></p> <ul style="list-style-type: none"> <li>• Allow the printer to cool down after a long print job.</li> <li>• Observe the recommended ambient temperature for the printer. For more information, see <a href="#">“Selecting a location for the printer” on page 13.</a></li> </ul> <p><b>b</b> Print the document.</p> <p>Is the printer printing slow?</p>	<p>Contact <a href="#">customer support</a>.</p>	<p>The problem is solved.</p>

### Adjusting toner darkness

- 1 From the home screen, touch **Settings > Print > Quality**.
- 2 In the Toner Darkness menu, adjust the settings.

### Job prints from the wrong tray or on the wrong paper

Action	Yes	No
<p><b>Step 1</b></p> <p><b>a</b> Check if you are printing on the correct paper.</p> <p><b>b</b> Print the document.</p> <p>Is the document printed on the correct paper?</p>	<p>Go to step 2.</p>	<p>Load the correct paper size and paper type.</p>
<p><b>Step 2</b></p> <p><b>a</b> Depending on your operating system, specify the paper size and paper type from the Printing Preferences or Print dialog.</p> <p><b>Note:</b> You can also change the settings on the printer control panel. Navigate to:</p> <p><b>Settings &gt; Paper &gt; Tray Configuration &gt; Paper Size/Type</b></p> <p><b>b</b> Make sure that the settings match the paper loaded.</p> <p><b>c</b> Print the document.</p> <p>Is the document printed on the correct paper?</p>	<p>The problem is solved.</p>	<p>Go to step 3.</p>
<p><b>Step 3</b></p> <p><b>a</b> Check if the trays are linked.</p> <p>For more information, see <a href="#">“Linking trays” on page 39.</a></p> <p><b>b</b> Print the document.</p> <p>Is the document printed from the correct tray?</p>	<p>The problem is solved.</p>	<p>Contact <a href="#">customer support</a>.</p>

## Confidential and other held documents do not print

Action	Yes	No
<p><b>Step 1</b></p> <p><b>a</b> From the control panel, check if the documents appear in the Held Jobs list.</p> <p><b>Note:</b> If the documents are not listed, then print the documents using the Print and Hold options.</p> <p><b>b</b> Print the documents.</p> <p>Are the documents printed?</p>	<p>The problem is solved.</p>	<p>Go to step 2.</p>
<p><b>Step 2</b></p> <p>The print job may contain a formatting error or invalid data.</p> <ul style="list-style-type: none"> <li>• Delete the print job, and then send it again.</li> <li>• For PDF files, generate a new file, and then print the documents.</li> </ul> <p>Are the documents printed?</p>	<p>The problem is solved.</p>	<p>Go to step 3.</p>
<p><b>Step 3</b></p> <p>If you are printing from the Internet, then the printer may be reading the multiple job titles as duplicates.</p> <p><b>For Windows users</b></p> <p><b>a</b> Open the Printing Preferences dialog.</p> <p><b>b</b> From the Print and Hold tab, click <b>Use Print and Hold</b>, and then click <b>Keep duplicate documents</b>.</p> <p><b>c</b> Enter a PIN, and then save the changes.</p> <p><b>d</b> Send the print job.</p> <p><b>For Macintosh users</b></p> <p><b>a</b> Save and name each job differently.</p> <p><b>b</b> Send the job individually.</p> <p>Are the documents printed?</p>	<p>The problem is solved.</p>	<p>Go to step 4.</p>
<p><b>Step 4</b></p> <p><b>a</b> Delete some held jobs to free up printer memory.</p> <p><b>b</b> Print the documents.</p> <p>Are the documents printed?</p>	<p>The problem is solved.</p>	<p>Go to step 5.</p>
<p><b>Step 5</b></p> <p><b>a</b> Add printer memory.</p> <p><b>b</b> Print the documents.</p> <p>Are the documents printed?</p>	<p>The problem is solved.</p>	<p>Contact <a href="#">customer support</a>.</p>

## The printer is not responding

Action	Yes	No
<p><b>Step 1</b> Check if the power cord is connected to the electrical outlet.</p> <p> <b>CAUTION—POTENTIAL INJURY:</b> To avoid the risk of fire or electrical shock, connect the power cord to an appropriately rated and properly grounded electrical outlet that is near the product and easily accessible.</p> <p>Is the printer responding?</p>	The problem is solved.	Go to step 2.
<p><b>Step 2</b> Check if the electrical outlet is turned off by a switch or breaker.</p> <p>Is the electrical outlet turned off by a switch or breaker?</p>	Turn on the switch or reset the breaker.	Go to step 3.
<p><b>Step 3</b> Check if the printer is on.</p> <p>Is the printer on?</p>	Go to step 4.	Turn on the printer.
<p><b>Step 4</b> Check if the printer is in Sleep or Hibernate mode.</p> <p>Is the printer in Sleep or Hibernate mode?</p>	Press the power button to wake the printer.	Go to step 5.
<p><b>Step 5</b> Check if the cables connecting the printer and the computer are inserted to the correct ports.</p> <p>Are the cables inserted to the correct ports?</p>	Go to step 6.	Insert the cables to the correct ports.
<p><b>Step 6</b> Turn off the printer, install the hardware options, and then turn on the printer. For more information, see the documentation that came with the option.</p> <p>Is the printer responding?</p>	The problem is solved.	Go to step 7.
<p><b>Step 7</b> Install the correct print driver.</p> <p>Is the printer responding?</p>	The problem is solved.	Go to step 8.
<p><b>Step 8</b> Turn off the printer, wait for about 10 seconds, and then turn on the printer.</p> <p>Is the printer responding?</p>	The problem is solved.	Contact <a href="#">customer support</a> .

## Unable to read flash drive

Action	Yes	No
<p><b>Step 1</b> Check if the printer is not busy processing another print, copy, scan, or fax job.</p> <p>Is the printer ready?</p>	Go to step 2.	Wait for the printer to finish processing the other job.
<p><b>Step 2</b> Check if the flash drive is supported. For more information, see <a href="#">“Supported flash drives and file types” on page 50.</a></p> <p>Is the flash drive supported?</p>	Go to step 3.	Insert a supported flash drive.
<p><b>Step 3</b></p> <p><b>a</b> Check if the USB port is enabled. For more information, see <a href="#">“Enabling the USB port” on page 273.</a></p> <p><b>b</b> Remove, and then insert the flash drive.</p> <p>Does the printer recognize the flash drive?</p>	The problem is solved.	Contact <a href="#">customer support</a> .

## Enabling the USB port

From the home screen, touch **Settings** > **Network/Ports** > **USB** > **Enable USB Port**.

## Network connection problems

### Cannot open Embedded Web Server

Action	Yes	No
<p><b>Step 1</b> Check if the printer is on.</p> <p>Is the printer on?</p>	Go to step 2.	Turn on the printer.
<p><b>Step 2</b> Make sure that the printer IP address is correct.</p> <p><b>Notes:</b></p> <ul style="list-style-type: none"> <li>View the IP address on the home screen.</li> <li>An IP address appears as four sets of numbers separated by periods, such as 123.123.123.123.</li> </ul> <p>Is the printer IP address correct?</p>	Go to step 3.	Type the correct printer IP address in the address field.

Action	Yes	No
<p><b>Step 3</b></p> <p>Check if you are using a supported browser:</p> <ul style="list-style-type: none"> <li>• Internet Explorer version 11 or later</li> <li>• Microsoft Edge</li> <li>• Safari version 6 or later</li> <li>• Google Chrome™ version 32 or later</li> <li>• Mozilla Firefox version 24 or later</li> </ul> <p>Is your browser supported?</p>	Go to step 4.	Install a supported browser.
<p><b>Step 4</b></p> <p>Check if the network connection is working.</p> <p>Is the network connection working?</p>	Go to step 5.	Contact your administrator.
<p><b>Step 5</b></p> <p>Make sure that the cable connections to the printer and print server are secure. For more information, see the documentation that came with the printer.</p> <p>Are the cable connections secure?</p>	Go to step 6.	Secure the cable connections.
<p><b>Step 6</b></p> <p>Check if the web proxy servers are disabled.</p> <p>Are the web proxy servers disabled?</p>	Go to step 7.	Contact your administrator.
<p><b>Step 7</b></p> <p>Access the Embedded Web Server.</p> <p>Did the Embedded Web Server open?</p>	The problem is solved.	Contact <a href="#">customer support</a> .

## Cannot connect the printer to the Wi-Fi network

Action	Yes	No
<p><b>Step 1</b></p> <p>Make sure that Active Adapter is set to Auto.</p> <p>From the home screen, touch <b>Settings &gt; Network/Ports &gt; Network Overview &gt; Active Adapter &gt; Auto</b>.</p> <p>Can the printer connect to the Wi-Fi network?</p>	The problem is solved.	Go to step 2.
<p><b>Step 2</b></p> <p>Check if the correct Wi-Fi network is selected.</p> <p><b>Note:</b> Some routers may share the default SSID.</p> <p>Are you connecting to the correct Wi-Fi network?</p>	Go to step 4.	Go to step 3.

Action	Yes	No
<p><b>Step 3</b>                      Connect to the correct Wi-Fi network. For more information, see <a href="#">“Connecting the printer to a Wi-Fi network” on page 169.</a></p> <p>Can the printer connect to the Wi-Fi network?</p>	The problem is solved.	Go to step 4.
<p><b>Step 4</b>                      Check the wireless security mode.                      From the home screen, touch <b>Settings &gt; Network/Ports &gt; Wireless &gt; Wireless Security Mode.</b></p> <p>Is the correct wireless security mode selected?</p>	Go to step 6.	Go to step 5.
<p><b>Step 5</b>                      Select the correct wireless security mode.</p> <p>Can the printer connect to the Wi-Fi network?</p>	The problem is solved.	Go to step 6.
<p><b>Step 6</b>                      Make sure that you entered the correct network password.  <b>Note:</b> Take note of the spaces, numbers, and capitalization in the password.</p> <p>Can the printer connect to the Wi-Fi network?</p>	The problem is solved.	Contact <a href="#">customer support.</a>

## Checking the printer connectivity

- 1 From the home screen, touch **Settings > Reports > Network > Network Setup Page.**
- 2 Check the first section of the network setup page, and confirm that the status is connected.  
 If the status is not connected, then the LAN drop may be inactive, or the network cable may be unplugged or malfunctioning. Contact your administrator for assistance.

## Hardware options problems

### Cannot detect internal option

Action	Yes	No
<p><b>Step 1</b> Turn off the printer, wait for about 10 seconds, and then turn on the printer.</p> <p>Does the internal option operate correctly?</p>	The problem is solved.	Go to step 2.
<p><b>Step 2</b> Print the Menu Settings Page, and then check if the internal option appears in the Installed Features list.</p> <p>Is the internal option listed in the menu settings page?</p>	Go to step 4.	Go to step 3.
<p><b>Step 3</b> Check if the internal option is installed properly into the controller board.</p> <ul style="list-style-type: none"> <li><b>a</b> Turn off the printer, and then unplug the power cord from the electrical outlet.</li> <li><b>b</b> Make sure that the internal option is installed in the appropriate connector in the controller board.</li> <li><b>c</b> Connect the power cord to the electrical outlet, and then turn on the printer.</li> </ul> <p> <b>CAUTION—POTENTIAL INJURY:</b> To avoid the risk of fire or electrical shock, connect the power cord to an appropriately rated and properly grounded electrical outlet that is near the product and easily accessible.</p> <p>Does the internal option operate correctly?</p>	The problem is solved.	Go to step 4.
<p><b>Step 4</b></p> <ul style="list-style-type: none"> <li><b>a</b> Check if the internal option is available in the print driver. <b>Note:</b> If necessary, manually add the internal option in the print driver to make it available for print jobs. For more information, see <a href="#">“Adding available options in the print driver” on page 320.</a></li> <li><b>b</b> Resend the print job.</li> </ul> <p>Does the internal option operate correctly?</p>	The problem is solved.	Contact <a href="#">customer support</a> .

### Defective flash detected

Try one or more of the following:

- Replace the defective flash memory.
- From the printer control panel, select **Continue** to ignore the message and continue printing.



- Cancel the current print job.

### Not enough free space in flash memory for resources

Try one or more of the following:

- From the printer control panel, select **Continue** to clear the message and continue printing.
- Delete fonts, macros, and other data stored in the flash memory.
- Install flash memory with larger capacity.

**Note:** Downloaded fonts and macros that are not previously stored in the flash memory are deleted.

### Unformatted flash detected

Try one or more of the following:

- From the control panel, select **Continue** to stop the defragmentation and continue printing.
- Format the flash memory.

**Note:** If the error message remains, then the flash memory may be defective and needs to be replaced.

## Issues with supplies

### Replace cartridge, printer region mismatch

To correct this problem, purchase a cartridge with the correct region that matches the printer region, or purchase a worldwide cartridge.

- The first number in the message after 42 indicates the region of the printer.
- The second number in the message after 42 indicates the region of the cartridge.

#### Printer and toner cartridge regions

Region	Numeric code
Worldwide or Undefined region	0
North America (United States, Canada)	1
European Economic Area, Western Europe, Nordic countries, Switzerland	2
Asia Pacific	3
Latin America	4
Rest of Europe, Middle East, Africa	5
Australia, New Zealand	6
Invalid region	9

**Note:** To find the region settings of the printer and toner cartridge, print the print quality test pages. From the control panel, navigate to: **Settings > Troubleshooting > Print Quality Test Pages.**

## Refilled regular [color] cartridge

The printer has detected a Lexmark Regular cartridge that has been refilled with non-genuine toner by a party other than Lexmark.

Select **OK** to continue.

All printer component life indicators are designed to function with Lexmark supplies and parts and may deliver unpredictable results when using supplies or parts in your Lexmark printer that are remanufactured by parties other than Lexmark.

For more information, see the printer statement of limited warranty.

## Non-Lexmark supply

The printer has detected a non-Lexmark supply or part installed in the printer.

Your Lexmark printer is designed to function best with genuine Lexmark supplies and parts. Use of third-party supplies or parts may affect the performance, reliability, or life of the printer and its imaging components.

All life indicators are designed to function with Lexmark supplies and parts and may deliver unpredictable results if third-party supplies or parts are used. Imaging component usage beyond the intended life may damage your Lexmark printer or associated components.

**Warning—Potential Damage:** Use of third-party supplies or parts can affect warranty coverage. Damage caused by the use of third-party supplies or parts may not be covered by the warranty.

To accept any and all of these risks and to proceed with the use of non-genuine supplies or parts in your printer, from the control panel, press and hold **X** and **#** simultaneously for 15 seconds.

If you do not want to accept these risks, then remove the third-party supply or part from your printer and install a genuine Lexmark supply or part. For more information, see [“Using genuine Lexmark parts and supplies” on page 188](#).

If the printer does not print after pressing and holding **X** and **#** simultaneously for 15 seconds, then reset the supply usage counter.

- 1 From the control panel, navigate to:  
**Settings > Device > Maintenance > Configuration Menu > Supply Usage And Counters**
- 2 Select the part or supply that you want to reset, and then select **Start**.
- 3 Read the warning message, and then select **Continue**.
- 4 Press and hold **X** and **#** simultaneously for 15 seconds to clear the message.

**Note:** If you are unable to reset the supply usage counters, then return the item to the place of purchase.

## Paper feed problems

### Envelope seals when printing

Action	Yes	No
<p><b>Step 1</b></p> <p><b>a</b> Use an envelope that has been stored in a dry environment.  <b>Note:</b> Printing on envelopes with high moisture content can seal the flaps.</p> <p><b>b</b> Send the print job.</p> <p>Does the envelope seal when printing?</p>	Go to step 2.	The problem is solved.
<p><b>Step 2</b></p> <p><b>a</b> Make sure that paper type is set to Envelope.            From the control panel, navigate to:  <b>Settings &gt; Paper &gt; Tray Configuration &gt; Paper Size/Type</b></p> <p><b>b</b> Send the print job.</p> <p>Does the envelope seal when printing?</p>	Contact <a href="#">customer support</a> .	The problem is solved.

### Collated printing does not work

Action	Yes	No
<p><b>Step 1</b></p> <p><b>a</b> From the control panel, navigate to:  <b>Settings &gt; Print &gt; Layout &gt; Collate</b></p> <p><b>b</b> Touch <b>On [1,2,1,2,1,2]</b>.</p> <p><b>c</b> Print the document.</p> <p>Is the document collated correctly?</p>	The problem is solved.	Go to step 2.
<p><b>Step 2</b></p> <p><b>a</b> From the document that you are trying to print, open the Print dialog, and then select <b>Collate</b>.</p> <p><b>b</b> Print the document.</p> <p>Is the document collated correctly?</p>	The problem is solved.	Go to step 3.
<p><b>Step 3</b></p> <p><b>a</b> Reduce the number of pages to print.</p> <p><b>b</b> Print the document.</p> <p>Are the pages collated correctly?</p>	The problem is solved.	Contact <a href="#">customer support</a> .

## Paper curl



**Note:** Before solving the problem, print the Print Quality Test Pages. From the control panel, navigate to **Settings > Troubleshooting > Print Quality Test Pages**. For non-touch-screen printer models, press  to navigate through the settings.

Action	Yes	No
<p><b>Step 1</b></p> <p><b>a</b> Check if the paper loaded is supported.  <b>Note:</b> If paper is not supported, then load a supported paper.</p> <p><b>b</b> Print the document.</p> <p>Is the paper curled?</p>	Go to step 2.	The problem is solved.
<p><b>Step 2</b></p> <p><b>a</b> Check if the printer is using a genuine and supported Lexmark toner cartridge.  <b>Note:</b> If the cartridge is not supported, then install a supported one.</p> <p><b>b</b> Print the document.</p> <p>Is the paper curled?</p>	Go to step 3.	The problem is solved.
<p><b>Step 3</b></p> <p><b>a</b> Adjust the guides in the tray to the correct position for the paper loaded.</p> <p><b>b</b> Print the document.</p> <p>Is the paper curled?</p>	Go to step 4.	The problem is solved.

Action	Yes	No
<p><b>Step 4</b></p> <p><b>a</b> Depending on your operating system, specify the paper size and paper type from the Printing Preferences or Print dialog.</p> <p><b>Notes:</b></p> <ul style="list-style-type: none"> <li>• Make sure that the settings match the paper loaded.</li> <li>• You can also change the setting on the printer control panel. Navigate to <b>Settings &gt; Paper &gt; Tray Configuration &gt; Paper Size/Type</b>.</li> </ul> <p><b>b</b> Print the document.</p> <p>Is the paper curled?</p>	Go to step 5.	The problem is solved.
<p><b>Step 5</b></p> <p><b>a</b> Remove paper, flip it over, and then reload paper.</p> <p><b>b</b> Print the document.</p> <p>Is the paper curled?</p>	Go to step 6.	The problem is solved.
<p><b>Step 6</b></p> <p><b>a</b> Load paper from a fresh package.</p> <p><b>Note:</b> Paper absorbs moisture due to high humidity. Store paper in its original wrapper until you are ready to use it.</p> <p><b>b</b> Print the document.</p> <p>Is the paper curled?</p>	Contact <a href="#">customer support</a> .	The problem is solved.

### Tray linking does not work

Action	Yes	No
<p><b>Step 1</b></p> <p><b>a</b> Check if the trays contain the same paper size and paper type.</p> <p><b>b</b> Check if the paper guides are positioned correctly.</p> <p><b>c</b> Print the document.</p> <p>Do the trays link correctly?</p>	The problem is solved.	Go to step 2.
<p><b>Step 2</b></p> <p><b>a</b> From the control panel, touch <b>Settings &gt; Paper &gt; Tray Configuration &gt; Paper Size/Type</b></p> <p><b>b</b> Set the paper size and paper type to match the paper loaded in the linked trays.</p> <p><b>c</b> Print the document.</p> <p>Do the trays link correctly?</p>	The problem is solved.	Go to step 3.

Action	Yes	No
<p><b>Step 3</b></p> <p><b>a</b> Make sure that Tray Linking is set to Automatic. For more information, see <a href="#">“Linking trays” on page 39</a>.</p> <p><b>b</b> Print the document.</p> <p>Do the trays link correctly?</p>	<p>The problem is solved.</p>	<p>Contact <a href="#">customer support</a>.</p>

## Paper frequently jams

Action	Yes	No
<p><b>Step 1</b></p> <p><b>a</b> Remove the tray.</p> <p><b>b</b> Check if paper is loaded correctly.</p> <p><b>Notes:</b></p> <ul style="list-style-type: none"> <li>• Make sure that the paper guides are positioned correctly.</li> <li>• Make sure that the stack height is below the maximum paper fill indicator.</li> <li>• Make sure to print on recommended paper size and type.</li> </ul> <p><b>c</b> Insert the tray.</p> <p><b>d</b> Print the document.</p> <p>Do paper jams occur frequently?</p>	<p>Go to step 2.</p>	<p>The problem is solved.</p>
<p><b>Step 2</b></p> <p><b>a</b> From the control panel, navigate to: <b>Settings &gt; Paper &gt; Tray Configuration &gt; Paper Size/Type</b></p> <p><b>b</b> Set the correct paper size and type.</p> <p><b>c</b> Print the document.</p> <p>Do paper jams occur frequently?</p>	<p>Go to step 3.</p>	<p>The problem is solved.</p>
<p><b>Step 3</b></p> <p><b>a</b> Load paper from a fresh package.</p> <p><b>Note:</b> Paper absorbs moisture due to high humidity. Store paper in its original wrapper until you are ready to use it.</p> <p><b>b</b> Print the document.</p> <p>Do paper jams occur frequently?</p>	<p>Contact <a href="#">customer support</a>.</p>	<p>The problem is solved.</p>

## Jammed pages are not reprinted

Action	Yes	No
<p><b>a</b> From the control panel, navigate to:  <b>Settings &gt; Device &gt; Notifications &gt; Jam Content Recovery</b></p> <p><b>b</b> In the Jam Recovery menu, select <b>On</b> or <b>Auto</b>.</p> <p><b>c</b> Print the document.</p> <p>Are the jammed pages reprinted?</p>	<p>The problem is solved.</p>	<p>Contact <a href="#">customer support</a>.</p>

## E-mailing problems

### Cannot send e-mails

Action	Yes	No
<p><b>Step 1</b>                      Make sure that the e-mail SMTP settings are configured correctly. For more information, see <a href="#">“Configuring the e-mail SMTP settings” on page 57</a>.</p> <p>Can you send an e-mail?</p>	<p>The problem is solved.</p>	<p>Go to step 2.</p>
<p><b>Step 2</b>                      Make sure that you are using the correct password. Depending on your e-mail service provider, use your account password, app password, or authentication password. For more information, see <a href="#">“Configuring the e-mail SMTP settings” on page 57</a>.</p> <p>Can you send an e-mail?</p>	<p>The problem is solved.</p>	<p>Go to step 3.</p>
<p><b>Step 3</b>                      Make sure that the printer is connected to a network and that the network is connected to the Internet.</p> <p>Can you send an e-mail?</p>	<p>The problem is solved.</p>	<p>Contact <a href="#">customer support</a>.</p>

## Faxing problems

### Caller ID is not shown

**Note:** These instructions apply only to printers that support analog fax. For more information, see [“Setting up the printer to fax” on page 66](#).

Action	Yes	No
<p>Enable caller ID.</p> <p>From the home screen, touch <b>Settings &gt; Fax &gt; Fax Setup &gt; Fax Receive Settings &gt; Admin Controls &gt; Enable Caller ID</b>.</p> <p>Does the caller ID appear?</p>	<p>The problem is solved.</p>	<p>Contact <a href="#">customer support</a>.</p>

### Cannot send or receive faxes using analog fax

Action	Yes	No
<p><b>Step 1</b></p> <p>Resolve any error messages that appear on the display.</p> <p>Can you send or receive a fax?</p>	<p>The problem is solved.</p>	<p>Go to step 2.</p>
<p><b>Step 2</b></p> <p>Make sure that the cable connections for the following equipment are secure:</p> <ul style="list-style-type: none"> <li>• Telephone</li> <li>• Handset</li> <li>• Answering machine</li> </ul> <p>Can you send or receive a fax?</p>	<p>The problem is solved.</p>	<p>Go to step 3.</p>
<p><b>Step 3</b></p> <p>Check for a dial tone.</p> <ul style="list-style-type: none"> <li>• Call the fax number to check if it is working properly.</li> <li>• If you are using the On Hook Dial feature, then turn up the volume to check if you hear a dial tone.</li> </ul> <p>Can you hear a dial tone?</p>	<p>Go to step 5.</p>	<p>Go to step 4.</p>



Action	Yes	No
<p><b>Step 4</b></p> <p>Check the telephone wall jack.</p> <ul style="list-style-type: none"> <li><b>a</b> Connect the analog telephone directly to the wall jack.</li> <li><b>b</b> Listen for a dial tone.</li> <li><b>c</b> If you do not hear a dial tone, then use a different telephone cable.</li> <li><b>d</b> If you still do not hear a dial tone, then connect the analog telephone to a different wall jack.</li> <li><b>e</b> If you hear a dial tone, then connect the printer to that wall jack.</li> </ul> <p>Can you send or receive a fax?</p>	<p>The problem is solved.</p>	<p>Go to step 5.</p>
<p><b>Step 5</b></p> <p>Check if the printer is connected to an analog phone service or to the correct digital connector.</p> <ul style="list-style-type: none"> <li>• If you are using an Integrated Services for Digital Network (ISDN) telephone service, then connect to an analog telephone port of an ISDN terminal adapter. For more information, contact your ISDN provider.</li> <li>• If you are using DSL, then connect to a DSL filter or router that supports analog use. For more information, contact your DSL provider.</li> <li>• If you are using a private branch exchange (PBX) telephone service, then make sure that you are connecting to an analog connection on the PBX. If none exists, then consider installing an analog telephone line for the fax machine.</li> </ul> <p>Can you send or receive a fax?</p>	<p>The problem is solved.</p>	<p>Go to step 6.</p>
<p><b>Step 6</b></p> <p>Temporarily disconnect other equipment and disable other telephone services.</p> <ul style="list-style-type: none"> <li><b>a</b> Disconnect other equipment (such as answering machines, computers, modems, or telephone line splitters) between the printer and the telephone line.</li> <li><b>b</b> Disable call waiting and voice mail. For more information, contact your telephone company.</li> </ul> <p>Can you send or receive a fax?</p>	<p>The problem is solved.</p>	<p>Go to step 7.</p>
<p><b>Step 7</b></p> <p>Scan the original document one page at a time.</p> <ul style="list-style-type: none"> <li><b>a</b> Dial the fax number.</li> <li><b>b</b> Scan the document.</li> </ul> <p>Can you send or receive a fax?</p>	<p>The problem is solved.</p>	<p>Contact <a href="#">customer support</a>.</p>

### Can receive but not send faxes using analog fax

Action	Yes	No
<p><b>Step 1</b> Load an original document properly into the ADF tray or on the scanner glass.</p> <p>Can you send faxes?</p>	The problem is solved.	Go to step 2.
<p><b>Step 2</b> Set up the shortcut number properly.</p> <ul style="list-style-type: none"> <li>• Check if the shortcut number is set for the telephone number that you want to dial.</li> <li>• Dial the telephone number manually.</li> </ul> <p>Can you send faxes?</p>	The problem is solved.	Contact <a href="#">customer support</a> .

### Can send but not receive faxes using analog fax

Action	Yes	No
<p><b>Step 1</b> Make sure that the paper source is not empty.</p> <p>Can you receive faxes?</p>	The problem is solved.	Go to step 2.
<p><b>Step 2</b> Check the ring count delay settings.</p> <p>From the home screen, touch <b>Settings &gt; Fax &gt; Fax Setup &gt; Fax Receive Settings &gt; Rings to Answer</b>.</p> <p>Can you receive faxes?</p>	The problem is solved.	Go to step 3.
<p><b>Step 3</b> If the printer is printing blank pages, then see <a href="#">“Blank or white pages” on page 242</a>.</p> <p>Can you receive faxes?</p>	The problem is solved.	Contact <a href="#">customer support</a> .

### Cannot set up etherFAX

Action	Yes	No
<p><b>Step 1</b> Check the printer connectivity.</p> <p><b>a</b> Print the Network Setup Page. From the home screen, touch <b>Settings &gt; Reports &gt; Network &gt; Network Setup Page</b>.</p> <p><b>b</b> Check the network status.</p> <p>Is the printer connected to the network?</p>	Go to step 3.	Go to step 2.

Action	Yes	No
<p><b>Step 2</b></p> <p>Make sure that the printer is connected to a network and that the network is connected to the Internet.</p> <p>Can you set up etherFAX?</p>	The problem is solved.	Go to step 3.
<p><b>Step 3</b></p> <p>Make sure that etherFAX is set up correctly. For more information, see <a href="#">“Setting up the fax function using etherFAX” on page 68.</a></p> <p>Can you set up etherFAX?</p>	The problem is solved.	Go to <a href="https://www.etherfax.net/lexmark">https://www.etherfax.net/lexmark</a> .

### Cannot send or receive faxes using etherFAX

Action	Yes	No
<p><b>Step 1</b></p> <p>Make sure that the printer is connected to a network and that the network is connected to the Internet.</p> <p>Can you send or receive faxes using etherFAX?</p>	The problem is solved.	Go to step 2.
<p><b>Step 2</b></p> <p><b>a</b> From the home screen, touch <b>Settings &gt; Fax &gt; Fax Setup &gt; General Fax Settings.</b></p> <p><b>b</b> Make sure that you have the correct fax number.</p> <p><b>c</b> Make sure that Fax Transport is set to etherFAX.</p> <p>Can you send or receive faxes using etherFAX?</p>	The problem is solved.	Go to step 3.
<p><b>Step 3</b></p> <p>Split large documents into smaller file sizes.</p> <p>Can you send or receive faxes using etherFAX?</p>	The problem is solved.	Go to <a href="https://www.etherfax.net/lexmark">https://www.etherfax.net/lexmark</a> .

### Poor fax print quality

Action	Yes	No
<p><b>Step 1</b></p> <p>Make sure that there are no print quality defects.</p> <p><b>a</b> From the control panel, touch <b>Settings &gt; Troubleshooting &gt; Print Quality Test Pages.</b></p> <p><b>b</b> Correct any print quality defects. For more information, see <a href="#">“Print quality is poor” on page 242.</a></p> <p>Is the fax print quality satisfactory?</p>	The problem is solved.	Go to step 2.

Action	Yes	No
<p><b>Step 2</b>                      Decrease the incoming fax transmission speed.</p> <p><b>a</b> From the control panel, touch <b>Settings &gt; Fax &gt; Fax Setup &gt; Fax Receive Settings &gt; Admin Controls</b>.</p> <p><b>b</b> In the Max Speed menu, select a lower transmission speed.</p> <p>Is the fax print quality satisfactory?</p>	<p>The problem is solved.</p>	<p>Contact <a href="#">customer support</a>.</p>

### Missing information on the fax cover page

Action	No	Yes
<p><b>a</b> Turn off the printer, wait for about 10 seconds, and then turn on the printer.</p> <p><b>b</b> Send or retrieve the fax.</p> <p>Is there missing information on the fax cover page?</p>	<p>The problem is solved.</p>	<p>Contact <a href="#">customer support</a>.</p>

### Cannot send the fax cover page from the computer

Action	Yes	No
<p><b>Step 1</b></p> <p><b>a</b> Make sure that the print driver is updated. For more information, see <a href="#">“Installing the printer software” on page 319</a>.</p> <p><b>b</b> Send the fax.</p> <p>Can you send the fax cover page?</p>	<p>The problem is solved.</p>	<p>Go to step 2.</p>
<p><b>Step 2</b></p> <p><b>a</b> From the document that you are trying to fax, open the Print dialog.</p> <p><b>b</b> Select the printer, and then click <b>Properties, Preferences, Options, or Setup</b>.</p> <p><b>c</b> Click <b>Fax</b>, and then clear the <b>Always display settings prior to faxing</b> setting.</p> <p><b>d</b> Send the fax.</p> <p>Can you send the fax cover page?</p>	<p>The problem is solved.</p>	<p>Contact <a href="#">customer support</a>.</p>

# Scanning problems

## Cannot scan to a computer

Action	Yes	No
<p><b>Step 1</b> Perform a copy job.</p> <p>Is the copy job successful?</p>	Go to step 3.	Go to step 2.
<p><b>Step 2</b>  <b>a</b> Turn off the printer, wait for about 10 seconds, and then turn it back on.  <b>b</b> Scan the document.</p> <p>Can you scan the document to a computer?</p>	The problem is solved.	Go to step 3.
<p><b>Step 3</b> Check the printer connectivity.</p> <p><b>a</b> Print the Network Setup Page. From the control panel, navigate to:  <b>Settings &gt; Reports &gt; Network &gt; Network Setup Page</b></p> <p><b>b</b> Check the network status.</p> <p>Is the printer connected to the network?</p>	Go to step 5.	Go to step 4.
<p><b>Step 4</b>  <b>a</b> Connect the printer to the network.  <b>b</b> Scan the document.</p> <p>Can you scan the document to a computer?</p>	The problem is solved.	Go to step 5.
<p><b>Step 5</b>  <b>a</b> Make sure that the printer and the computer are connected to the same network.  <b>b</b> Scan the document.</p> <p>Can you scan the document to a computer?</p>	The problem is solved.	Contact <a href="#">customer support</a> .

## Cannot scan to a network folder

Action	Yes	No
<p><b>Step 1</b></p> <p><b>a</b> Create a network folder shortcut.</p> <p><b>b</b> Scan a document using the shortcut. For more information, see <a href="#">“Scanning to a network folder” on page 80</a>.</p> <p>Can you scan a document and save it to a network folder?</p>	<p>The problem is solved.</p>	<p>Go to step 2.</p>
<p><b>Step 2</b></p> <p>Make sure that the network folder path and format are correct. For example, <code>//server_hostname/foldername/path</code>, where <code>server_hostname</code> is a fully qualified domain (FQDN) or IP address.</p> <p>Is the network folder path and format correct?</p>	<p>Go to step 3.</p>	<p>Go to step 4.</p>
<p><b>Step 3</b></p> <p>Make sure that you have a write access permission to the network folder.</p> <p>Can you scan a document and save it to a network folder?</p>	<p>The problem is solved.</p>	<p>Go to step 4.</p>

Action	Yes	No
<p><b>Step 4</b></p> <p>Update the network folder shortcut.</p> <p><b>a</b> Open a web browser, and then type the printer IP address in the address field.</p> <p><b>Notes:</b></p> <ul style="list-style-type: none"> <li>View the printer IP address on the home screen. The IP address appears as four sets of numbers separated by periods, such as 123.123.123.123.</li> <li>If you are using a proxy server, then temporarily disable it to load the web page correctly.</li> </ul> <p><b>b</b> Click <b>Shortcuts</b>, and then select a shortcut.</p> <p><b>Note:</b> If you have multiple shortcut types, then select <b>Network Folder</b>.</p> <p><b>c</b> In the Share Path field, type the network folder path.</p> <p><b>Notes:</b></p> <ul style="list-style-type: none"> <li>If your share path is <code>\\server_hostname\foldername\path</code>, then type <code>//server_hostname/foldername/path</code>.</li> <li>Make sure that you use forward slashes when typing the share path.</li> </ul> <p><b>d</b> From the Authentication menu, select your authentication method.</p> <p><b>Note:</b> If Authentication is set to “Use assigned username and password,” then in the User Name and Password fields, type your credentials.</p> <p><b>e</b> Click <b>Save</b>.</p> <p>Can you scan a document and save it to a network folder?</p>	<p>The problem is solved.</p>	<p>Go to step 5.</p>
<p><b>Step 5</b></p> <p>Make sure that the printer and the network folder are connected to the same network.</p> <p>Can you scan a document and save it to a network folder?</p>	<p>The problem is solved.</p>	<p>Contact <a href="#">customer support</a>.</p>

### Partial copies of document or photo

Action	Yes	No
<p><b>Step 1</b></p> <p><b>a</b> Make sure that the document or photo is loaded facedown on the upper left corner of the scanner glass.</p> <p><b>b</b> Copy the document or photo.</p> <p>Is the document or photo copied correctly?</p>	<p>The problem is solved.</p>	<p>Go to step 2.</p>

Action	Yes	No
<p><b>Step 2</b></p> <p><b>a</b> Match the paper size setting and the paper loaded in the tray.</p> <p><b>b</b> Copy the document or photo.</p> <p>Is the document or photo copied correctly?</p>	<p>The problem is solved.</p>	<p>Contact <a href="#">customer support</a>.</p>

### Poor copy quality

Action	Yes	No
<p><b>Step 1</b></p> <p><b>a</b> Clean the scanner glass and the ADF glass with a damp, soft, lint-free cloth. If your printer has a second ADF glass inside the ADF, then also clean that glass. For more information, see <a href="#">“Cleaning the scanner” on page 174</a>.</p> <p><b>b</b> Make sure that the document or photo is loaded facedown on the upper left corner of the scanner glass.</p> <p><b>c</b> Copy the document or photo.</p> <p>Is the copy quality satisfactory?</p>	<p>The problem is solved.</p>	<p>Go to step 2.</p>
<p><b>Step 2</b></p> <p><b>a</b> Check the quality of the original document or photo.</p> <p><b>b</b> Adjust the scan quality settings.</p> <p><b>c</b> Copy the document or photo.</p> <p>Is the copy quality satisfactory?</p>	<p>The problem is solved.</p>	<p>Contact <a href="#">customer support</a>.</p>

### Vertical dark streaks on output when scanning from the ADF

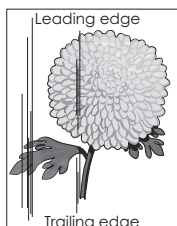
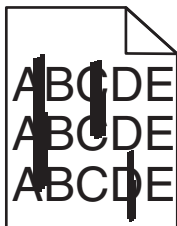



Action	Yes	No
<p><b>a</b> Open the scanner cover.</p> <p><b>b</b> Using a damp, soft, lint-free cloth, wipe the ADF glass and the ADF glass pad.</p> <p><b>c</b> Close the scanner cover.</p> <p><b>d</b> Scan the document.</p> <p>Do vertical streaks appear on scanned documents?</p>	Contact <a href="#">customer support</a> .	The problem is solved.

### Jagged image or text when scanning from the ADF

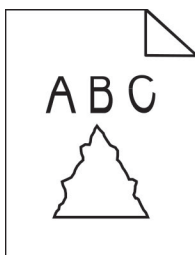

Action	Yes	No
<p><b>a</b> Load 50 sheets of clean, plain paper into the ADF.</p> <p><b>Note:</b> The plain paper helps clean or remove dust and other coating from the ADF feed rollers.</p> <p><b>b</b> From the control panel, press .</p> <p><b>c</b> Load an original document into the ADF.</p> <p><b>d</b> Scan the document.</p> <p>Do jagged images or texts appear on the output?</p>	Contact <a href="#">customer support</a> .	The problem is solved.

### Scan job was not successful

Action	Yes	No
<p><b>Step 1</b></p> <p>Check the cable connections.</p> <p><b>a</b> Make sure that the Ethernet or USB cable is securely connected to the computer and the printer.</p> <p><b>b</b> Resend the scan job.</p> <p>Is the scan job successful?</p>	The problem is solved.	Go to step 2.

Action	Yes	No
<p><b>Step 2</b></p> <p>Check the file you want to scan.</p> <ul style="list-style-type: none"> <li><b>a</b> Make sure that the file name is not already used in the destination folder.</li> <li><b>b</b> Make sure that the document or photo you want to scan is not open in another application.</li> <li><b>c</b> Resend the scan job.</li> </ul> <p>Is the scan job successful?</p>	The problem is solved.	Go to step 3.
<p><b>Step 3</b></p> <ul style="list-style-type: none"> <li><b>a</b> Make sure that the <b>Append time stamp</b> or the <b>Overwrite existing file</b> check box is selected in the destination configuration settings.</li> <li><b>b</b> Resend the scan job.</li> </ul> <p>Is the scan job successful?</p>	The problem is solved.	Contact <a href="#">customer support</a> .

### Scanner does not close

Action	Yes	No
<p>Remove obstructions that keep the scanner cover open.</p> <p>Did the scanner cover close correctly?</p>	The problem is solved.	Contact <a href="#">customer support</a> .

### Scanning takes too long or freezes the computer

Action	Yes	No
<p>Close all applications that are interfering with the scan.</p> <p>Does scanning take too long or freeze the computer?</p>	Contact <a href="#">customer support</a> .	The problem is solved.

## Scanner does not respond

Action	Yes	No
<p><b>Step 1</b></p> <p><b>a</b> Check if the power cord is connected properly to the printer and the electrical outlet.</p> <p> <b>CAUTION—POTENTIAL INJURY:</b> To avoid the risk of fire or electrical shock, connect the power cord to an appropriately rated and properly grounded electrical outlet that is near the product and easily accessible.</p> <p><b>b</b> Copy or scan the document.</p> <p>Is the scanner responding?</p>	The problem is solved.	Go to step 2.
<p><b>Step 2</b></p> <p><b>a</b> Check if the printer is turned on.</p> <p><b>b</b> Resolve any error messages that appear on the display.</p> <p><b>c</b> Copy or scan the document.</p> <p>Is the scanner responding?</p>	The problem is solved.	Go to step 3.
<p><b>Step 3</b></p> <p><b>a</b> Turn off the printer, wait for about 10 seconds, and then turn the printer on.</p> <p><b>b</b> Copy or scan the document.</p> <p>Is the scanner responding?</p>	The problem is solved.	Contact <a href="#">customer support</a> .

## Adjusting scanner registration

- 1 From the home screen, touch **Settings > Device > Maintenance > Configuration Menu > Scanner Configuration > Scanner Manual Registration**.
- 2 In the Print Quick Test menu, touch **Start**.
- 3 Place the Print Quick Test page on the scanner glass, and then touch **Flatbed Registration**.
- 4 In the Copy Quick Test menu, touch **Start**.
- 5 Compare the Copy Quick Test page with the original document.
 

**Note:** If the margins of the test page are different from the original document, then adjust Left Margin and Top Margin.
- 6 Repeat [step 4](#) and [step 5](#) until the margins of the Copy Quick Test page closely match the original document.

## Adjusting ADF registration

- 1 From the home screen, touch **Settings > Device > Maintenance > Configuration Menu > Scanner Configuration > Scanner Manual Registration**.
- 2 In the Print Quick Test menu, touch **Start**.

**3** Place the Print Quick Test page on the ADF tray.

**4** Touch **Front ADF Registration** or **Rear ADF Registration**.

**Notes:**

- To align Front ADF Registration, place the test page faceup, short edge first into the ADF.
- To align Rear ADF Registration, place the test page facedown, short edge first into the ADF.

**5** In the Copy Quick Test menu, touch **Start**.

**6** Compare the Copy Quick Test page with the original document.

**Note:** If the margins of the test page are different from the original document, then adjust Horizontal Adjust and Top Margin.

**7** Repeat [step 5](#) and [step 6](#) until the margins of the Copy Quick Test page closely match the original document.

## Contacting customer support

Before contacting customer support, make sure to have the following information:

- Printer problem
- Error message
- Printer model type and serial number

Go to <http://support.lexmark.com> to receive e-mail or chat support, or browse through the library of manuals, support documentation, drivers, and other downloads.

Technical support via telephone is also available. In the U.S. or Canada, call 1-800-539-6275. For other countries or regions, go to <http://support.lexmark.com>.

# Upgrading and migrating

## Hardware

### Available internal options

- Memory cards
  - DDR3 DIMM
  - Flash memory
- Optional cards
  - Font cards
  - Firmware cards
    - Forms and Bar Code
    - PRESCRIBE
    - IPDS
- Printer hard disk
- Internal solutions port
  - Parallel 1284-B Interface Card
  - RS-232C Serial Interface Card
  - Fiber Interface Card
  - N8370 802.11a/b/g/n/ac Wireless Print Server Interface Card

### Accessing the controller board



**CAUTION—SHOCK HAZARD:** To avoid the risk of electrical shock, if you are accessing the controller board or installing optional hardware or memory devices sometime after setting up the printer, then turn the printer off, and unplug the power cord from the electrical outlet before continuing. If you have any other devices attached to the printer, then turn them off as well, and unplug any cables going into the printer.

- 1** Turn off the printer.
- 2** Unplug the power cord from the electrical outlet, and then from the printer.
- 3** Using a flat-head screwdriver, open the controller board access cover.

**Warning—Potential Damage:** Controller board electronic components are easily damaged by static electricity. Touch a metal surface on the printer before touching any controller board components or connectors.

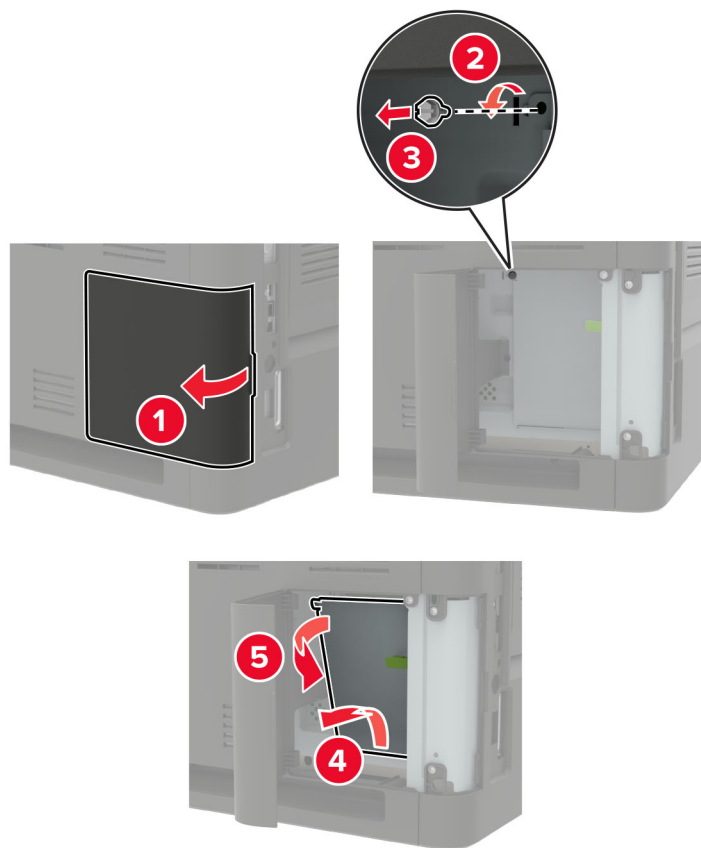

**4** Install any supported internal options. For more information, see the documentation that came with the option.

- 5 Close the access cover.

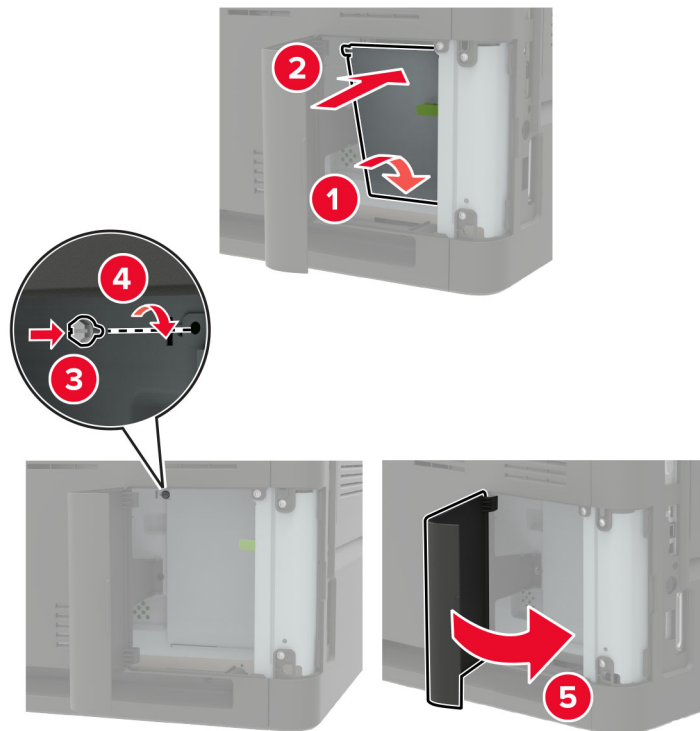

- 6 Connect the power cord to the printer, and then to the electrical outlet.

**CAUTION—POTENTIAL INJURY:** To avoid the risk of fire or electrical shock, connect the power cord to an appropriately rated and properly grounded electrical outlet that is near the product and easily accessible.

- 7 Turn on the printer.

## Installing a memory card

**Note:** These instructions apply only to the DDR3 DIMM memory card.

**CAUTION—SHOCK HAZARD:** To avoid the risk of electrical shock, if you are accessing the controller board or installing optional hardware or memory devices sometime after setting up the printer, then turn the printer off, and unplug the power cord from the electrical outlet before continuing. If you have any other devices attached to the printer, then turn them off as well, and unplug any cables going into the printer.

- 1 Turn off the printer.
- 2 Unplug the power cord from the electrical outlet, and then from the printer.
- 3 Using a flat-head screwdriver, open the controller board access cover.

**Warning—Potential Damage:** Controller board electronic components are easily damaged by static electricity. Touch a metal surface on the printer before touching any controller board components or connectors.

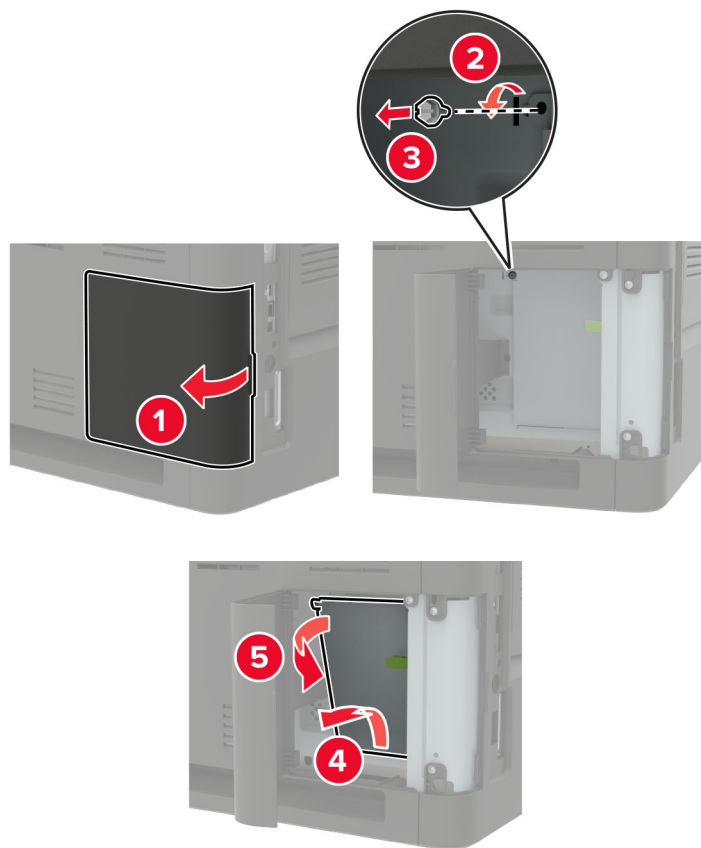

4 Unpack the memory card.

**Warning—Potential Damage:** Do not touch the connection points along the edge of the card.

5 Insert the memory card until it *clicks* into place.

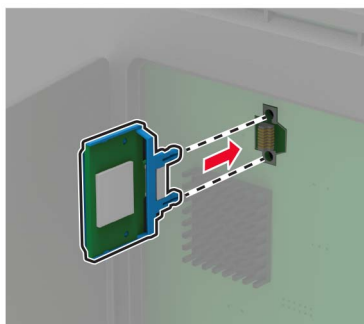



- 6 Close the access cover.

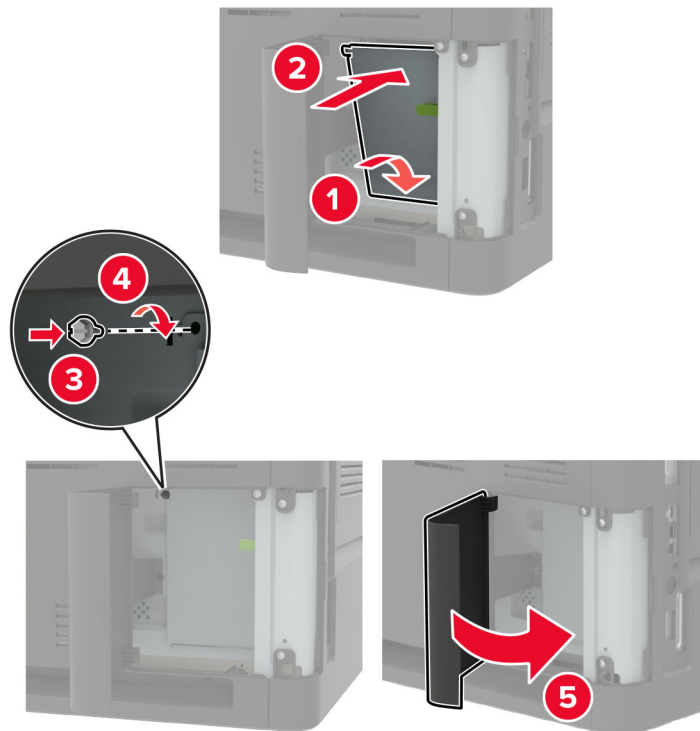

- 7 Connect the power cord to the printer, and then to the electrical outlet.

**CAUTION—POTENTIAL INJURY:** To avoid the risk of fire or electrical shock, connect the power cord to an appropriately rated and properly grounded electrical outlet that is near the product and easily accessible.

- 8 Turn on the printer.

## Installing an optional card

**Note:** An optional card is either a font card, firmware card, or flash memory.

**CAUTION—SHOCK HAZARD:** To avoid the risk of electrical shock, if you are accessing the controller board or installing optional hardware or memory devices sometime after setting up the printer, then turn the printer off, and unplug the power cord from the electrical outlet before continuing. If you have any other devices attached to the printer, then turn them off as well, and unplug any cables going into the printer.

- 1 Turn off the printer.
- 2 Unplug the power cord from the electrical outlet, and then from the printer.
- 3 Using a flat-head screwdriver, open the controller board access cover.

**Warning—Potential Damage:** Controller board electronic components are easily damaged by static electricity. Touch a metal surface on the printer before touching any components or connectors.

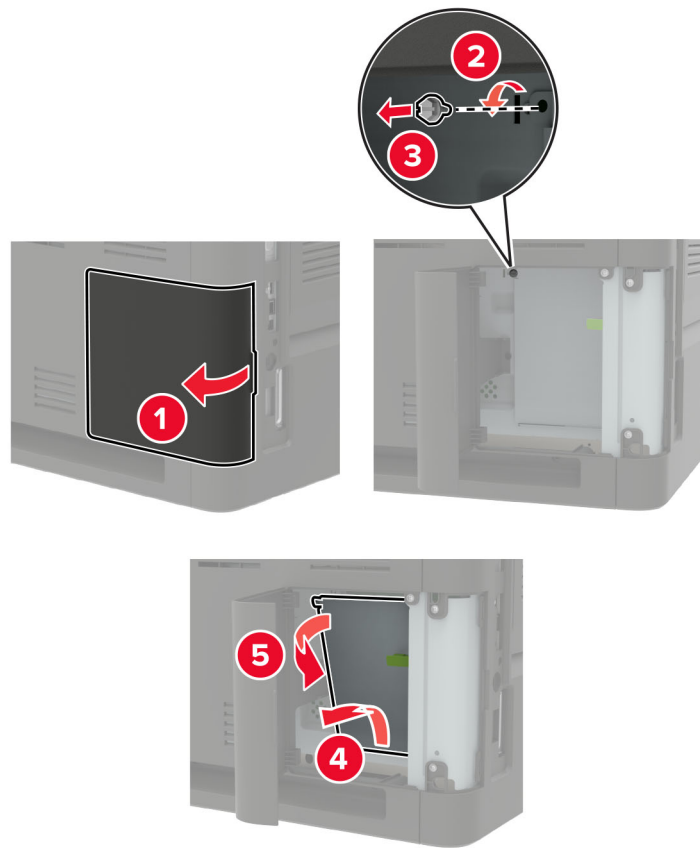

- 4 Unpack the optional card.

**Warning—Potential Damage:** Do not touch the connection points along the edge of the card.

- 5 Push the card firmly into place.

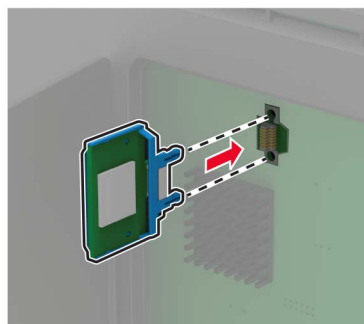

**Note:** The entire length of the connector on the card must touch and be flush against the controller board.

**Warning—Potential Damage:** Improper installation of the card may cause damage to the card and the controller board.

- 6 Close the access cover.

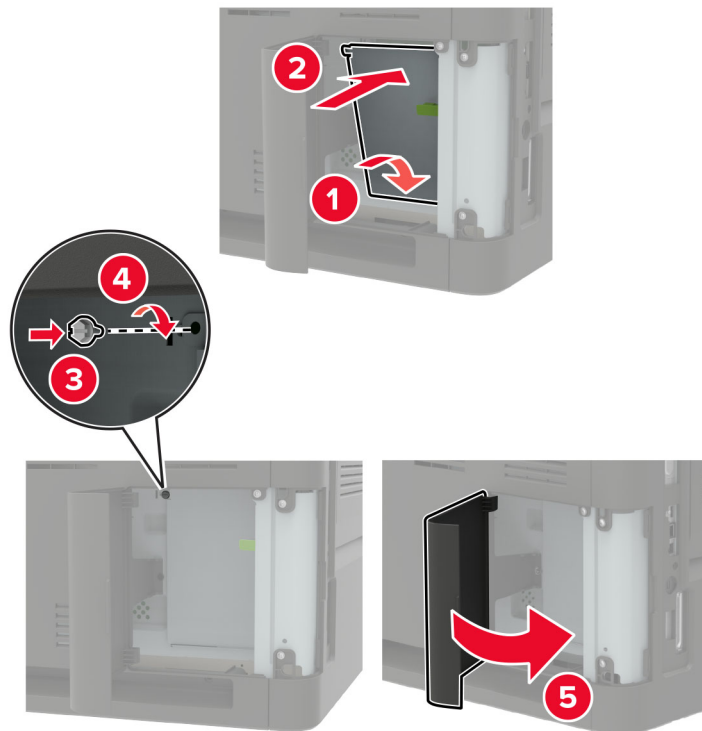

- 7 Connect the power cord to the printer, and then to the electrical outlet.

**CAUTION—POTENTIAL INJURY:** To avoid the risk of fire or electrical shock, connect the power cord to an appropriately rated and properly grounded electrical outlet that is near the product and easily accessible.

- 8 Turn on the printer.

## Installing a printer hard disk

**CAUTION—SHOCK HAZARD:** To avoid the risk of electrical shock, if you are accessing the controller board or installing optional hardware or memory devices sometime after setting up the printer, then turn the printer off, and unplug the power cord from the electrical outlet before continuing. If you have any other devices attached to the printer, then turn them off as well, and unplug any cables going into the printer.

- 1 Turn off the printer.
- 2 Unplug the power cord from the electrical outlet, and then from the printer.
- 3 Using a flat-head screwdriver, open the controller board access cover.

**Warning—Potential Damage:** Controller board electronic components are easily damaged by static electricity. Touch a metal surface on the printer before touching any controller board components or connectors.

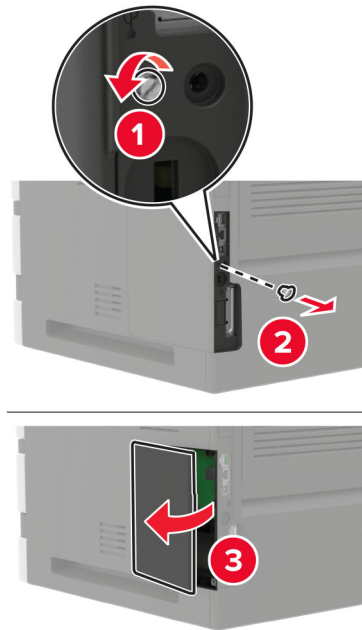

4 Unpack the hard disk.

5 Attach the hard disk, and then connect the hard disk interface cable to the controller board.

**Warning—Potential Damage:** Do not touch or press the center of the hard disk.

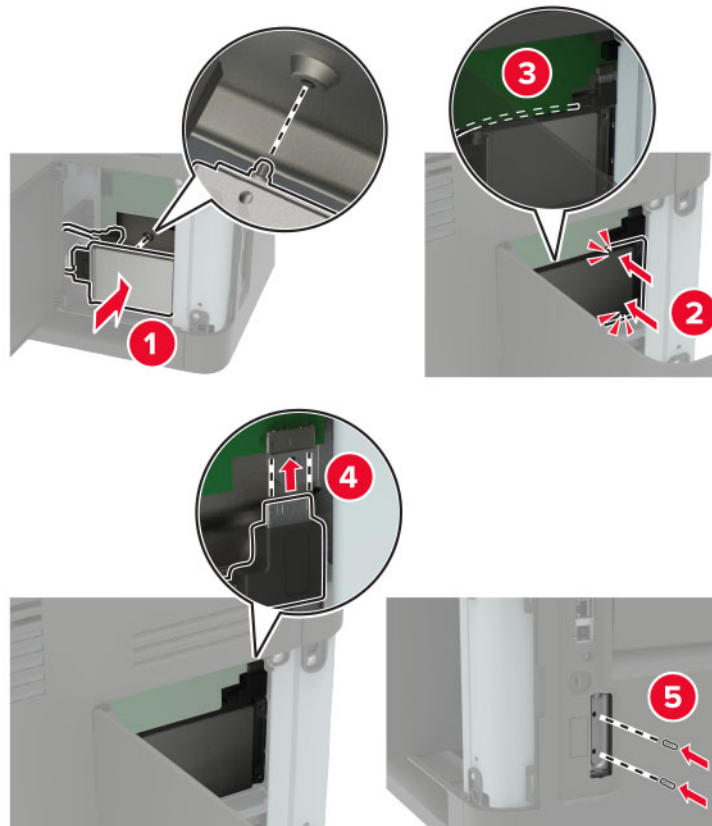

- 6 Close the access cover.
- 7 Connect the power cord to the printer, and then to the electrical outlet.

**⚠ CAUTION—POTENTIAL INJURY:** To avoid the risk of fire or electrical shock, connect the power cord to an appropriately rated and properly grounded electrical outlet that is near the product and easily accessible.

- 8 Turn on the printer.

## Installing an internal solutions port

**⚠ CAUTION—SHOCK HAZARD:** To avoid the risk of electrical shock, if you are accessing the controller board or installing optional hardware or memory devices sometime after setting up the printer, then turn the printer off, and unplug the power cord from the electrical outlet before continuing. If you have any other devices attached to the printer, then turn them off as well, and unplug any cables going into the printer.

- 1 Turn off the printer, and then unplug the power cord from the electrical outlet.
- 2 Using a flat-head screwdriver, open the controller board access cover.

**Warning—Potential Damage:** Controller board electronic components are easily damaged by static electricity. Touch a metal surface on the printer before touching any controller board components or connectors.

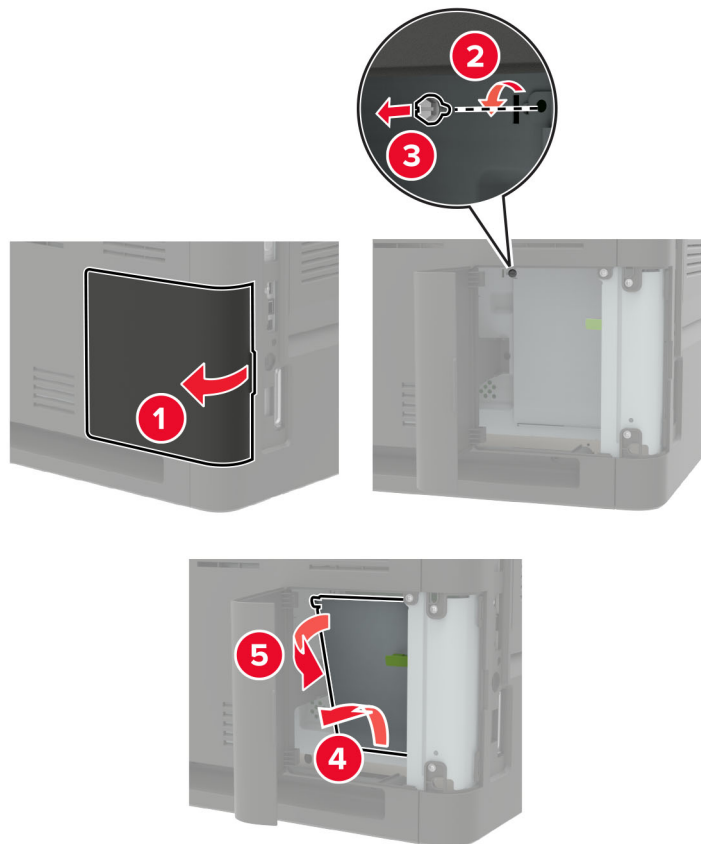

**3** Unpack the internal solutions port (ISP) kit.

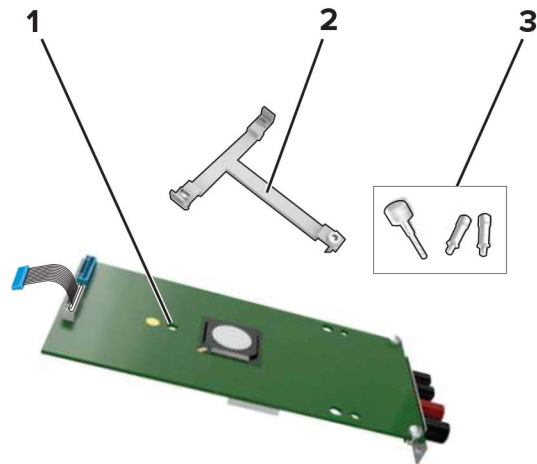

<b>1</b>	ISP
<b>2</b>	Mounting bracket
<b>3</b>	Thumbscrews

**4** If necessary, remove the printer hard disk.

**5** Insert the bracket into the board until it *clicks* into place.

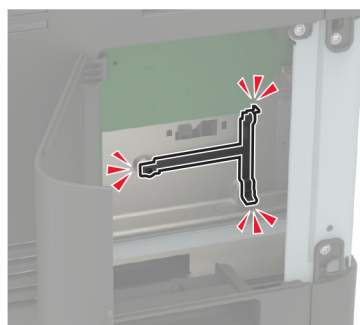
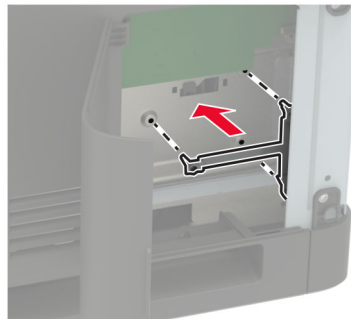

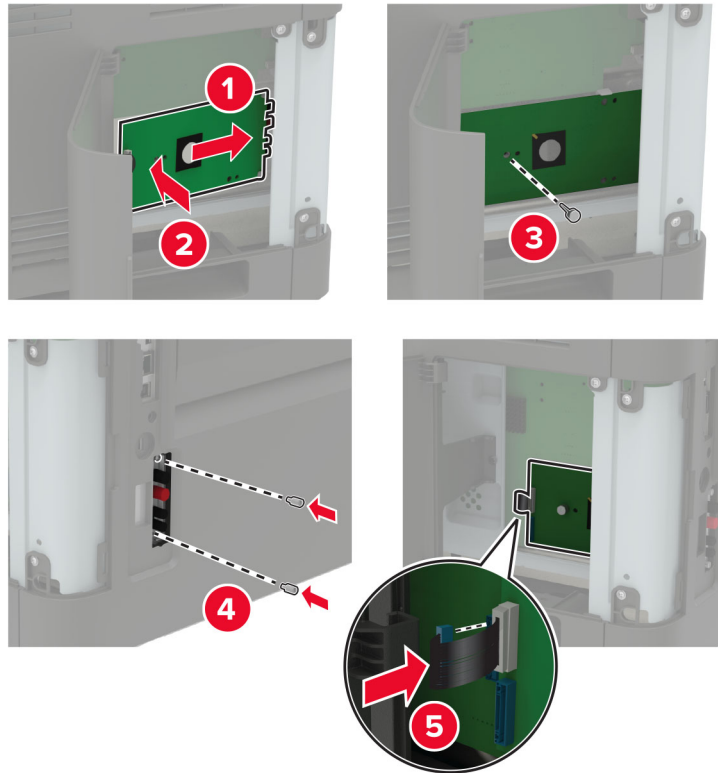
**6** Attach the ISP to the bracket.**7** If necessary, attach the hard disk to the ISP.

- a** Remove the hard disk bracket.

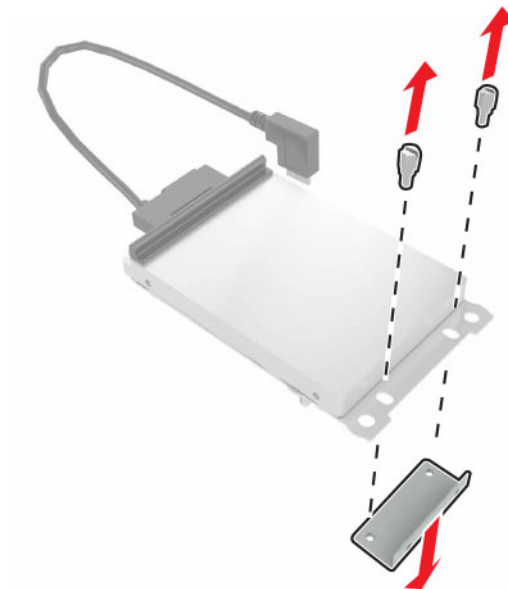

- b** Connect the hard disk to the ISP.

**Warning—Potential Damage:** Do not touch or press the center of the hard disk.

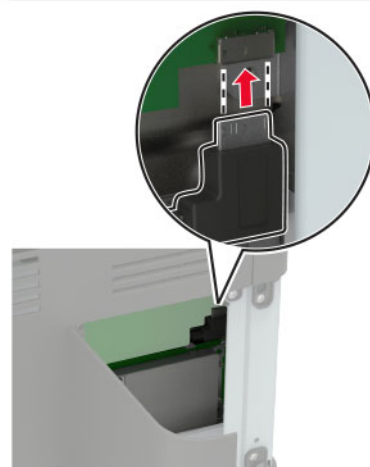
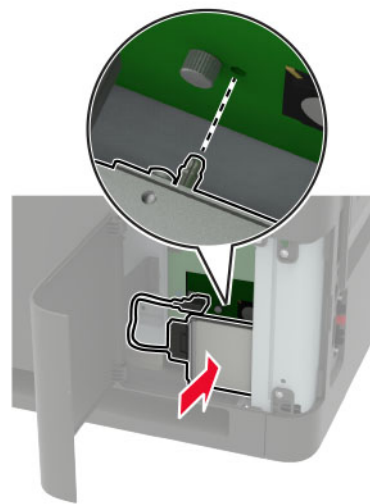



- 8 Close the access cover.

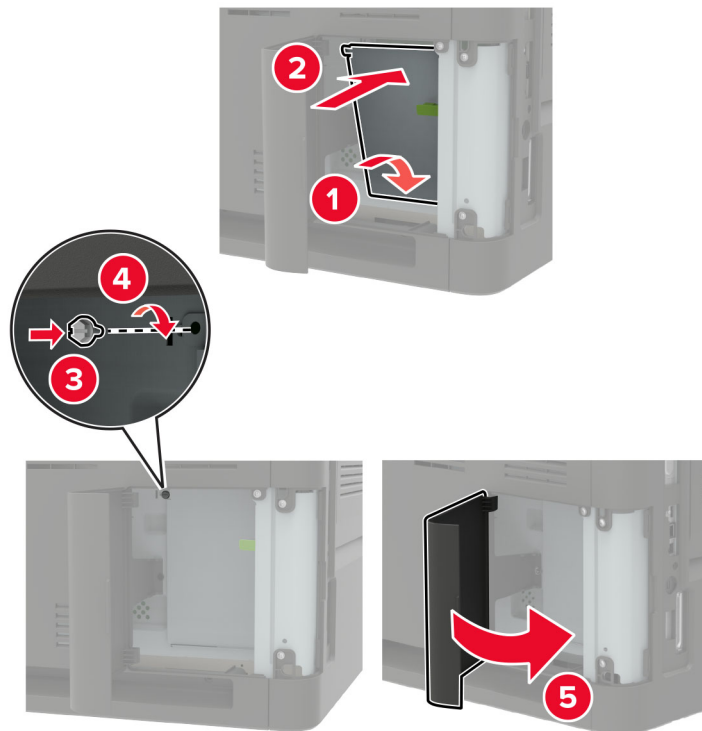

- 9 Connect the power cord to the electrical outlet, and then turn on the printer.

**CAUTION—POTENTIAL INJURY:** To avoid the risk of fire or electrical shock, connect the power cord to an appropriately rated and properly grounded electrical outlet that is near the product and easily accessible.

## Installing the 550-sheet tray

**CAUTION—SHOCK HAZARD:** To avoid the risk of electrical shock, if you are accessing the controller board or installing optional hardware or memory devices sometime after setting up the printer, then turn the printer off, and unplug the power cord from the electrical outlet before continuing. If you have any other devices attached to the printer, then turn them off as well, and unplug any cables going into the printer.

**CAUTION—TIPPING HAZARD:** Installing one or more options on your printer or MFP may require a caster base, furniture, or other feature to prevent instability causing possible injury. For more information on supported configurations, see [www.lexmark.com/multifunctionprinters](http://www.lexmark.com/multifunctionprinters).

- 1 Turn off the printer.
- 2 Unplug the power cord from the electrical outlet, and then from the printer.
- 3 Unpack the optional tray, and then remove all packing material.

**Note:** If optional trays are already installed, then unlock them from the printer before lifting the printer. Do not try to lift the printer and trays at the same time.

- 4 Align the printer with the optional tray, and then lower the printer until it *clicks* into place.

- ⚠ CAUTION—POTENTIAL INJURY:** If the printer weight is greater than 20 kg (44 lb), then it may require two or more people to lift it safely.

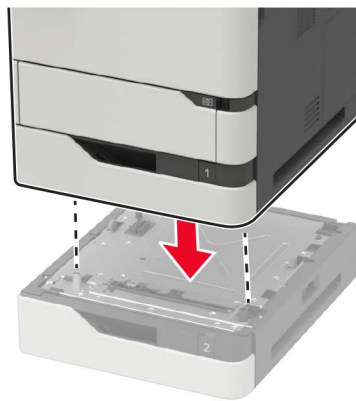

- 5 Connect the power cord to the printer, and then to the electrical outlet.

- ⚠ CAUTION—POTENTIAL INJURY:** To avoid the risk of fire or electrical shock, connect the power cord to an appropriately rated and properly grounded electrical outlet that is near the product and easily accessible.

- 6 Turn on the printer.

Add the tray in the print driver to make it available for print jobs. For more information, see [“Adding available options in the print driver” on page 320](#).

## Installing the 2100-sheet tray

- ⚠ CAUTION—SHOCK HAZARD:** To avoid the risk of electrical shock, if you are accessing the controller board or installing optional hardware or memory devices sometime after setting up the printer, then turn the printer off, and unplug the power cord from the electrical outlet before continuing. If you have any other devices attached to the printer, then turn them off as well, and unplug any cables going into the printer.

- ⚠ CAUTION—TIPPING HAZARD:** Installing one or more options on your printer or MFP may require a caster base, furniture, or other feature to prevent instability causing possible injury. For more information on supported configurations, see [www.lexmark.com/multifunctionprinters](http://www.lexmark.com/multifunctionprinters).

- 1 Turn off the printer.
- 2 Unplug the power cord from the electrical outlet, and then from the printer.
- 3 Unpack the tray, and then remove all packing material.

**Note:** If optional trays are already installed, then unlock them from the printer before lifting the printer. Do not try to lift the printer and trays at the same time.

- 4 Install the tray on the caster base.

**Note:** Make sure that the caster base wheels are locked.

- ⚠ CAUTION—POTENTIAL INJURY:** If the tray weight is greater than 20 kg (44 lb), then it may require two or more people to lift it safely.

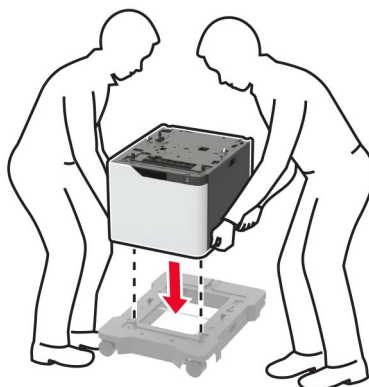

**5** Align the printer with the tray, and then lower the printer until it *clicks* into place.

 **CAUTION—POTENTIAL INJURY:** If the printer weight is greater than 20 kg (44 lb), then it may require two or more people to lift it safely.

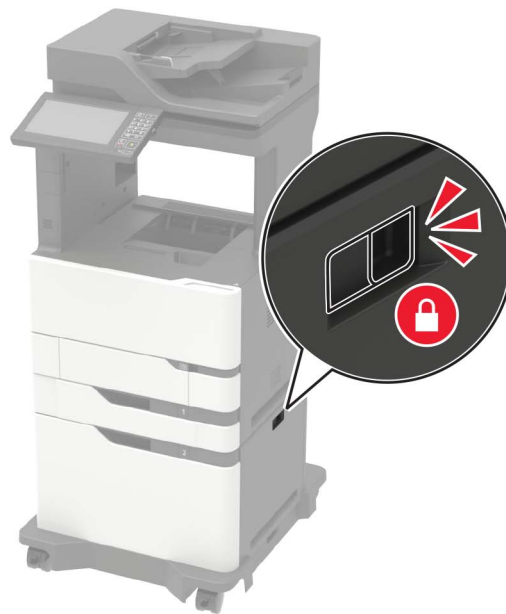

**6** Connect the power cord to the printer, and then to the electrical outlet.

**⚠ CAUTION—POTENTIAL INJURY:** To avoid the risk of fire or electrical shock, connect the power cord to an appropriately rated and properly grounded electrical outlet that is near the product and easily accessible.

**7** Turn on the printer.

Add the tray in the print driver to make it available for print jobs. For more information, see [“Adding available options in the print driver” on page 320](#).

## Installing the 4-bin mailbox

**⚠ CAUTION—TIPPING HAZARD:** Installing one or more options on your printer or MFP may require a caster base, furniture, or other feature to prevent instability causing possible injury. For more information on supported configurations, see [www.lexmark.com/multifunctionprinters](http://www.lexmark.com/multifunctionprinters).

- 1 Turn off the printer.
- 2 Unplug the power cord from the electrical outlet, and then from the printer.
- 3 Unpack the mailbox.
- 4 Remove the printer top cover.

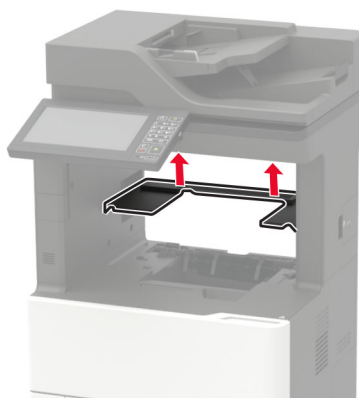

- 5 Install the mailbox to the printer, and then push it down to make sure that it is securely attached to the printer.

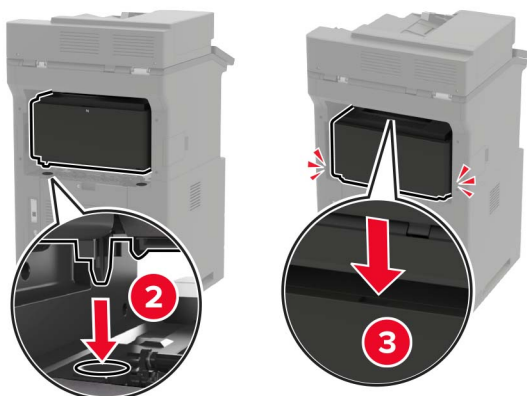

- 6 Connect the power cord to the printer, and then to the electrical outlet.

**⚠ CAUTION—POTENTIAL INJURY:** To avoid the risk of fire or electrical shock, connect the power cord to an appropriately rated and properly grounded electrical outlet that is near the product and easily accessible.

- 7 Turn on the printer.

Add the mailbox in the print driver to make it available for print jobs. For more information, see [“Adding available options in the print driver” on page 320](#).

## Installing the offset stacker

**⚠ CAUTION—TIPPING HAZARD:** Installing one or more options on your printer or MFP may require a caster base, furniture, or other feature to prevent instability causing possible injury. For more information on supported configurations, see [www.lexmark.com/multifunctionprinters](http://www.lexmark.com/multifunctionprinters).

- 1 Turn off the printer.
- 2 Unplug the power cord from the electrical outlet, and then from the printer.
- 3 Unpack the offset stacker.
- 4 Remove the printer top cover.

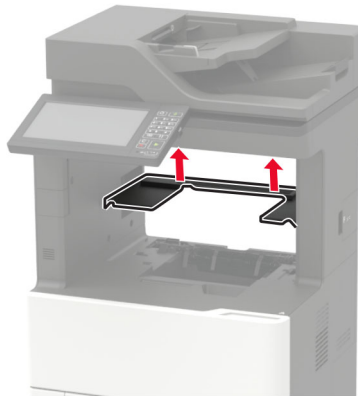

- 5 Install the offset stacker to the printer, and then push it down to make sure that it is securely attached to the printer.

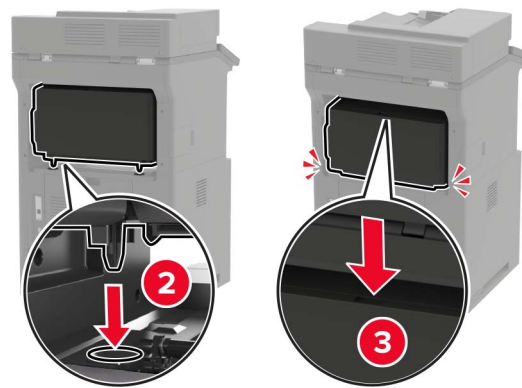

- 6 Connect the power cord to the printer, and then to the electrical outlet.

**⚠ CAUTION—POTENTIAL INJURY:** To avoid the risk of fire or electrical shock, connect the power cord to an appropriately rated and properly grounded electrical outlet that is near the product and easily accessible.

- 7 Turn on the printer.

Add the offset stacker in the print driver to make it available for print jobs. For more information, see [“Adding available options in the print driver” on page 320](#).

## Installing the staple finisher

**⚠ CAUTION—TIPPING HAZARD:** Installing one or more options on your printer or MFP may require a caster base, furniture, or other feature to prevent instability causing possible injury. For more information on supported configurations, see [www.lexmark.com/multifunctionprinters](http://www.lexmark.com/multifunctionprinters).

- 1 Turn off the printer.
- 2 Unplug the power cord from the electrical outlet, and then from the printer.
- 3 Unpack the staple finisher.

- 4 Remove the printer top cover.

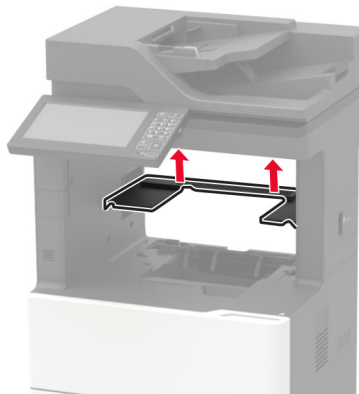

- 5 Install the staple finisher to the printer, and then push it down to make sure that it is securely attached to the printer.

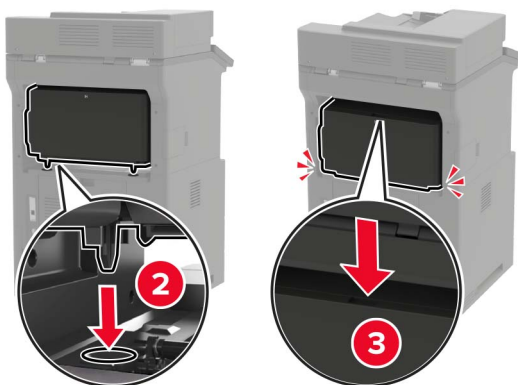

- 6 Connect the power cord to the printer, and then to the electrical outlet.

**⚠ CAUTION—POTENTIAL INJURY:** To avoid the risk of fire or electrical shock, connect the power cord to an appropriately rated and properly grounded electrical outlet that is near the product and easily accessible.

- 7 Turn on the printer.

Add the staple finisher in the print driver to make it available for print jobs. For more information, see [“Adding available options in the print driver” on page 320](#).



## Installing the staple, hole punch finisher

**CAUTION—TIPPING HAZARD:** Installing one or more options on your printer or MFP may require a caster base, furniture, or other feature to prevent instability causing possible injury. For more information on supported configurations, see [www.lexmark.com/multifunctionprinters](http://www.lexmark.com/multifunctionprinters).

- 1 Turn off the printer.
- 2 Unplug the power cord from the electrical outlet, and then from the printer.
- 3 Unpack the staple, hole punch finisher.
- 4 Remove the printer top cover.

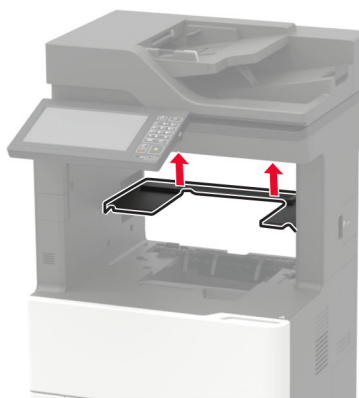

- 5 Install the finisher to the printer, and then push it down to make sure that it is securely attached to the printer.

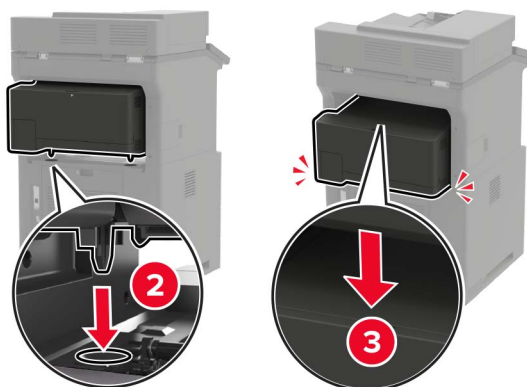

6 Connect the power cord to the printer, and then to the electrical outlet.

 **CAUTION—POTENTIAL INJURY:** To avoid the risk of fire or electrical shock, connect the power cord to an appropriately rated and properly grounded electrical outlet that is near the product and easily accessible.

7 Turn on the printer.

Add the finisher in the print driver to make it available for print jobs. For more information, see [“Adding available options in the print driver” on page 320](#).

## Software

### Supported operating systems

Using the software CD, you can install the printer software on the following operating systems:

- Windows 10
- Windows 8.1
- Windows Server 2012 R2
- Windows Server 2012
- Windows 7 SP1
- Windows Server 2008 R2 SP1
- Windows Server 2008 SP2
- Windows Vista SP2
- Mac OS X version 10.7 or later
- Red Hat Enterprise Linux WS
- openSUSE Linux
- SUSE Linux Enterprise Server
- Debian GNU/Linux
- Ubuntu
- Fedora
- IBM AIX
- Oracle Solaris SPARC
- Oracle Solaris x86

#### Notes:

- For Windows operating systems, the print drivers and utilities are supported in both 32- and 64-bit versions.
- For drivers and utilities that are compatible with Mac OS X version 10.6 or earlier and for specific supported Linux or UNIX operating system versions, go to <http://support.lexmark.com>.
- For more information on software compatibility with all other operating systems, contact customer support.

## Installing the printer software

### Notes:

- The print driver is included in the software installer package.
  - For Macintosh computers with macOS version 10.7 or later, you do not need to install the driver to print on an AirPrint-certified printer. If you want custom printing features, then download the print driver.
- 1 Obtain a copy of the software installer package.
    - From the software CD that came with your printer.
    - Go to [www.lexmark.com/downloads](http://www.lexmark.com/downloads).
  - 2 Run the installer, and then follow the instructions on the computer screen.

## Installing the fax driver

- 1 Go to [www.lexmark.com/downloads](http://www.lexmark.com/downloads), search for your printer model, and then download the appropriate installer package.
- 2 From your computer, click **Printer Properties**, and then navigate to the **Configuration** tab.
- 3 Select **Fax**, and then click **Apply**.

## Adding printers to a computer

Before you begin, do one of the following:

- Connect the printer and the computer to the same network. For more information on connecting the printer to a network, see [“Connecting the printer to a Wi-Fi network” on page 169](#).
- Connect the computer to the printer. For more information, see [“Connecting a computer to the printer” on page 171](#).
- Connect the printer to the computer using a USB cable. For more information, see [“Attaching cables” on page 17](#).

**Note:** The USB cable is sold separately.

### For Windows users

- 1 From a computer, install the print driver.

**Note:** For more information, see [“Installing the printer software” on page 319](#).
- 2 Open **Printers & scanners**, and then click **Add a printer or scanner**.
- 3 Depending on your printer connection, do one of the following:
  - Select a printer from the list, and then click **Add device**.
  - Click **Show Wi-Fi Direct printers**, select a printer, and then click **Add device**.
  - Click **The printer that I want isn't listed**, and then from the Add Printer window, do the following:
    - a Select **Add a printer using a TCP/IP address or hostname**, and then click **Next**.
    - b In the “Hostname or IP address” field, type the printer IP address, and then click **Next**.

**Notes:**

- View the printer IP address on the printer home screen. The IP address appears as four sets of numbers separated by periods, such as 123.123.123.123.
  - If you are using a proxy server, then temporarily disable it to load the web page correctly.
- c** Select a print driver, and then click **Next**.
  - d** Select **Use the print driver that is currently installed (recommended)**, and then click **Next**.
  - e** Type a printer name, and then click **Next**.
  - f** Select a printer sharing option, and then click **Next**.
  - g** Click **Finish**.

**For Macintosh users**

- 1** From a computer, open **Printers & Scanners**.
- 2** Click **+**, and then select a printer.
- 3** From the Use menu, select a print driver.

**Notes:**

- To use the Macintosh print driver, select either **AirPrint** or **Secure AirPrint**.
- If you want custom printing features, then select the Lexmark print driver. To install the driver, see [“Installing the printer software” on page 319](#).

- 4** Add the printer.

**Adding available options in the print driver****For Windows users**

- 1** Open the printers folder.
- 2** Select the printer you want to update, and then do either of the following:
  - For Windows 7 or later, select **Printer properties**.
  - For earlier versions, select **Properties**.
- 3** Navigate to the Configuration tab, and then select **Update Now - Ask Printer**.
- 4** Apply the changes.

**For Macintosh users**

- 1** From System Preferences in the Apple menu, navigate to your printer, and then select **Options & Supplies**.
- 2** Navigate to the list of hardware options, and then add any installed options.
- 3** Apply the changes.

# Firmware

## Exporting or importing a configuration file

You can export the configuration settings of your printer into a text file, and then import the file to apply the settings to other printers.

- 1 Open a web browser, and then type the printer IP address in the address field.

**Notes:**

- View the printer IP address on the printer home screen. The IP address appears as four sets of numbers separated by periods, such as 123.123.123.123.
- If you are using a proxy server, then temporarily disable it to load the web page correctly.

- 2 From the Embedded Web Server, click **Export Configuration** or **Import Configuration**.

- 3 Follow the instructions on the screen.

- 4 If the printer supports applications, then do the following:

- a Click **Apps** > select the application > **Configure**.
- b Click **Export** or **Import**.

## Updating firmware

### Updating the firmware using the control panel

#### Using the notification center

This method is applicable only in some printer models.

- 1 From the control panel, navigate to the notification center, and then select **Firmware update available**.

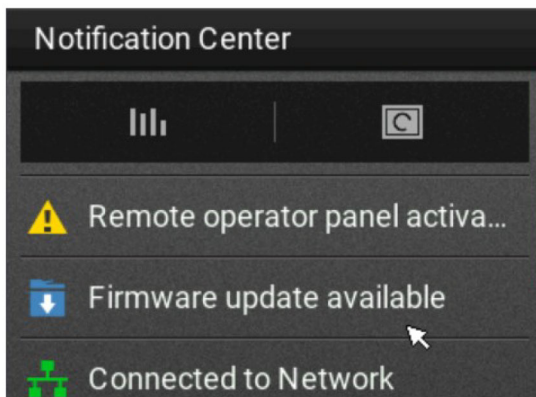

## 2 Select **Install now**.

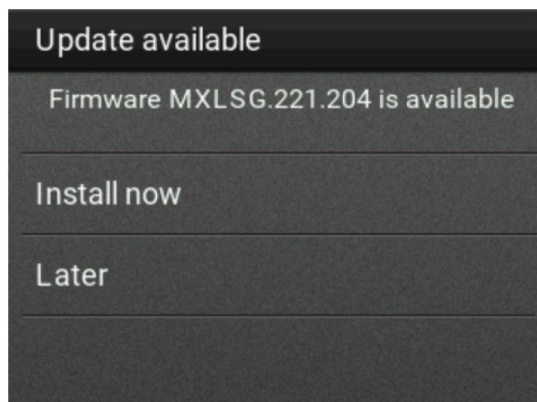

The printer reboots automatically after the update.

### Using the Settings menu

- 1 From the control panel, navigate to **Settings > Device > Update Firmware**.
- 2 Depending on your printer model, select **Check for updates** or **Check for updates now**.
- 3 If a new update is available, then select **Install now**.

The printer reboots automatically after the update.

## Updating the firmware using the Embedded Web Server

Before you begin, make sure that:

- You have downloaded the latest printer firmware from <https://support.lexmark.com> and saved it to your flash drive or computer.

**Note:** To deploy the printer firmware, extract the .fls firmware file from the ZIP package.

- You are not using a special code on your printer to avoid losing this functionality.

**Warning—Potential Damage:** Make sure that all printers receiving firmware updates are turned on during the entire firmware update process. Turning off a printer during a firmware update can severely damage it.

If the printer is connected to the network when checking for updates, then downloading the firmware is not required.

- 1 Open a web browser, and then type the printer IP address in the address field.

#### Notes:

- View the printer IP address on the printer home screen. The IP address appears as four sets of numbers separated by periods, such as 123.123.123.123.
- If you are using a proxy server, then temporarily disable it to load the web page correctly.

- 2 Click **Device**.

- 3 Scroll down, and then click **Update Firmware**.

- 4 Depending on your printer model, click **Check for updates** or **Check for updates now**.

If a new update is available, then click **I agree, start update**.

The printer reboots automatically after the update.

# Notices

## Product information

Product name:

Lexmark MX822ade, Lexmark MX822adtfe, Lexmark MX822adxe, Lexmark MX822de; Lexmark MX826ade, Lexmark MX826adtfe, Lexmark MX826adxe, Lexmark MX826de; Lexmark XM7355, Lexmark XM7355b, Lexmark XM7355bi, Lexmark XM7355i; Lexmark XM7370, Lexmark XM7370i MFPs

Machine type:

7465

Models:

436, 496, 836, 896

## Edition notice

March 2024

**The following paragraph does not apply to any country where such provisions are inconsistent with local law:** LEXMARK INTERNATIONAL, INC., PROVIDES THIS PUBLICATION "AS IS" WITHOUT WARRANTY OF ANY KIND, EITHER EXPRESS OR IMPLIED, INCLUDING, BUT NOT LIMITED TO, THE IMPLIED WARRANTIES OF MERCHANTABILITY OR FITNESS FOR A PARTICULAR PURPOSE. Some states do not allow disclaimer of express or implied warranties in certain transactions; therefore, this statement may not apply to you.

This publication could include technical inaccuracies or typographical errors. Changes are periodically made to the information herein; these changes will be incorporated in later editions. Improvements or changes in the products or the programs described may be made at any time.

References in this publication to products, programs, or services do not imply that the manufacturer intends to make these available in all countries in which it operates. Any reference to a product, program, or service is not intended to state or imply that only that product, program, or service may be used. Any functionally equivalent product, program, or service that does not infringe any existing intellectual property right may be used instead. Evaluation and verification of operation in conjunction with other products, programs, or services, except those expressly designated by the manufacturer, are the user's responsibility.

For Lexmark technical support, go to <http://support.lexmark.com>.

For information on Lexmark's privacy policy governing the use of this product, go to [www.lexmark.com/privacy](http://www.lexmark.com/privacy).

For information on supplies and downloads, go to [www.lexmark.com](http://www.lexmark.com).

© 2018 Lexmark International, Inc.

All rights reserved.

## GOVERNMENT END USERS

The Software Program and any related documentation are "Commercial Items," as that term is defined in 48 C.F.R. 2.101, "Computer Software" and "Commercial Computer Software Documentation," as such terms are used in 48 C.F.R. 12.212 or 48 C.F.R. 227.7202, as applicable. Consistent with 48 C.F.R. 12.212 or 48 C.F.R.



227.7202-1 through 227.7207-4, as applicable, the Commercial Computer Software and Commercial Software Documentation are licensed to the U.S. Government end users (a) only as Commercial Items and (b) with only those rights as are granted to all other end users pursuant to the terms and conditions herein.

## Trademarks

Lexmark and the Lexmark logo are trademarks or registered trademarks of Lexmark International, Inc. in the United States and/or other countries.

Gmail, Android, Google Play, and Google Chrome are trademarks of Google LLC.

Macintosh, Safari, and AirPrint are trademarks of Apple Inc., registered in the U.S. and other countries. App Store and iCloud are service marks of Apple Inc., registered in the U.S. and other countries. Use of the Works with Apple badge means that an accessory has been designed to work specifically with the technology identified in the badge and has been certified by the developer to meet Apple performance standards.

The Mopria® word mark is a registered and/or unregistered trademark of Mopria Alliance, Inc. in the United States and other countries. Unauthorized use is strictly prohibited.

PCL® is a registered trademark of the Hewlett-Packard Company. PCL is Hewlett-Packard Company’s designation of a set of printer commands (language) and functions included in its printer products. This printer is intended to be compatible with the PCL language. This means the printer recognizes PCL commands used in various application programs, and that the printer emulates the functions corresponding to the commands.

PostScript is a registered trademark of Adobe Systems Incorporated in the United States and/or other countries.

Wi-Fi® and Wi-Fi Direct® are registered trademarks of Wi-Fi Alliance®.

All other trademarks are the property of their respective owners.

## Licensing notices

All licensing notices associated with this product can be viewed from the CD:\NOTICES directory of the installation software CD.

## Noise emission levels

The following measurements were made in accordance with ISO 7779 and reported in conformance with ISO 9296.

**Note:** Some modes may not apply to your product.

1-meter average sound pressure, dBA	
Printing	One-sided: 54 (MX822, XM7355); 56 (MX826, XM7370) Two-sided: 53 (MX822, XM7355); 55 (MX826, XM7370)
Scanning	57
Copying	58 (MX822, XM7355); 59 (MX826, XM7370)
Ready	14

Values are subject to change. See [www.lexmark.com](http://www.lexmark.com) for current values.

## Waste from Electrical and Electronic Equipment (WEEE) directive

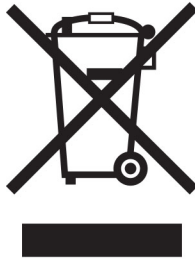

The WEEE logo signifies specific recycling programs and procedures for electronic products in countries of the European Union. We encourage the recycling of our products.

If you have further questions about recycling options, visit the Lexmark Web site at [www.lexmark.com](http://www.lexmark.com) for your local sales office phone number.

## India E-Waste notice

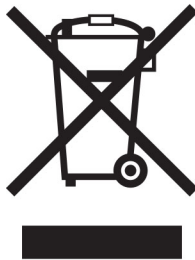

This product including components, consumables, parts and spares complies with the “India E-Waste Rules” and prohibits use of lead, mercury, hexavalent chromium, polybrominated biphenyls or polybrominated diphenyl ethers in concentrations exceeding 0.1% by weight and 0.01% by weight for cadmium, except for the exemption set in the Rule.

## Product disposal

Do not dispose of the printer or supplies in the same manner as normal household waste. Consult your local authorities for disposal and recycling options.

## EU battery directive

This product may contain a coin-cell lithium rechargeable battery. This product is in compliance with EU Directive 2006/66/EC as amended by Directive 2008/12/EC, 2008/103/EC, and 2013/56/EU.

## Returning Lexmark cartridges for reuse or recycling

The Lexmark Cartridge Collection Program allows you to return used cartridges for free to Lexmark for reuse or recycling. One hundred percent of the empty cartridges returned to Lexmark are either reused or demanufactured for recycling. The boxes used to return the cartridges are also recycled.

To return Lexmark cartridges for reuse or recycling, do the following:

- 1 Go to [www.lexmark.com/recycle](http://www.lexmark.com/recycle).
- 2 Select the product that you want to recycle.

Static sensitivity notice

## Static sensitivity notice

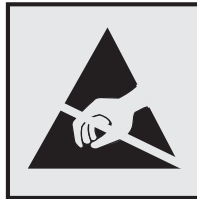

This symbol identifies static-sensitive parts. Do not touch the areas near these symbols without first touching a metal surface in an area away from the symbol.

To prevent damage from electrostatic discharge when performing maintenance tasks such as clearing paper jams or replacing supplies, touch any exposed metal frame of the printer before accessing or touching interior areas of the printer even if the symbol is not present.

## ENERGY STAR

Any Lexmark product bearing the ENERGY STAR® emblem on the product or on a start-up screen is certified to comply with Environmental Protection Agency (EPA) ENERGY STAR requirements as of the date of manufacture.



## Temperature information

Operating temperature and relative humidity	10 to 32.2°C (50 to 90°F) and 15 to 80% RH
Printer / cartridge / imaging unit long-term storage <sup>1</sup>	15.3 to 32.2°C (60 to 90°F) and 8 to 15% RH Maximum wet bulb temperature: 22.8°C (73°F)
Printer / cartridge / imaging unit short-term shipping	-40 to 43.3°C (-40 to 110°F)
<p><sup>1</sup> Supplies shelf life is approximately 2 years. This is based on storage in a standard office environment at 22°C (72°F) and 45% humidity.</p> <p><sup>2</sup> Wet-bulb temperature is determined by the air temperature and the relative humidity.</p>	

## Laser notice

The printer is certified in the U.S. to conform to the requirements of DHHS 21 CFR, Chapter I, Subchapter J for Class I (1) laser products, and elsewhere is certified as a Class I laser product conforming to the requirements of IEC 60825-1: 2014.

Class I laser products are not considered to be hazardous. The laser system and printer are designed so there is never any human access to laser radiation above a Class I level during normal operation, user maintenance, or prescribed service conditions. The printer has a non-serviceable printhead assembly that contains a laser with the following specifications:

Class: IIIb (3b) AlGaAs

Nominal output power (milliwatts): 25

Wavelength (nanometers): 755–800

## Power consumption

### Product power consumption

The following table documents the power consumption characteristics of the product.

**Note:** Some modes may not apply to your product.

Mode	Description	Power consumption (Watts)
Printing	The product is generating hard-copy output from electronic inputs.	One-sided: 690 (MX822, XM7355); 850 (MX826, XM7370) Two-sided: 490 (MX822, XM7355); 640 (MX826, XM7370)
Copy	The product is generating hard-copy output from hard-copy original documents.	750 (MX822, XM7355); 900 (MX826, XM7370)
Scan	The product is scanning hard-copy documents.	84 (MX822, XM7355); 86 (MX826, XM7370)

Mode	Description	Power consumption (Watts)
Ready	The product is waiting for a print job.	Higher power usage: 58 (MX822, XM7355); 50 (MX826, XM7370) Lower power usage: 36.5 (MX822, XM7355); 35 (MX826, XM7370)
Sleep Mode	The product is in a high-level energy-saving mode.	1.78 (MX822, XM7355); 2.94 (MX826, XM7370)
Hibernate	The product is in a low-level energy-saving mode.	0.2
Off	The product is plugged into an electrical outlet, but the power switch is turned off.	0.2

The power consumption levels listed in the previous table represent time-averaged measurements. Instantaneous power draws may be substantially higher than the average.

Values are subject to change. See [www.lexmark.com](http://www.lexmark.com) for current values.

### Sleep Mode

This product is designed with an energy-saving mode called *Sleep Mode*. The Sleep Mode saves energy by lowering power consumption during extended periods of inactivity. The Sleep Mode is automatically engaged after this product is not used for a specified period of time, called the *Sleep Mode Timeout*.

Factory default Sleep Mode Timeout for this product (in minutes):	15
---	----

By using the configuration menus, the Sleep Mode Timeout can be modified between 1 minute and 120 minutes. If the print speed is less than or equal to 30 pages per minute, then you can set the timeout only up to 60 minutes. Setting the Sleep Mode Timeout to a low value reduces energy consumption, but may increase the response time of the product. Setting the Sleep Mode Timeout to a high value maintains a fast response, but uses more energy.

### Hibernate Mode

This product is designed with an ultra-low power operating mode called *Hibernate mode*. When operating in Hibernate Mode, all other systems and devices are powered down safely.

The Hibernate mode can be entered in any of the following methods:

- Using the Hibernate Timeout
- Using the Schedule Power modes

Factory default Hibernate Timeout for this product in all countries or regions	3 days
--	--------

The amount of time the printer waits after a job is printed before it enters Hibernate mode can be modified between one hour and one month.

### Notes on EPEAT-registered imaging equipment products:

- Standby power level occurs in Hibernate or Off mode.
- The product shall automatically power down to a standby power level of  $\leq 1$  W. The auto standby function (Hibernate or Off) shall be enabled at product shipment.

## Off mode

If this product has an off mode which still consumes a small amount of power, then to completely stop product power consumption, disconnect the power supply cord from the electrical outlet.

Total energy usage

## Total energy usage

It is sometimes helpful to estimate the total product energy usage. Since power consumption claims are provided in power units of Watts, the power consumption should be multiplied by the time the product spends in each mode in order to calculate energy usage. The total product energy usage is the sum of each mode's energy usage.

## Applicability of Regulation (EU) 2019/2015 and (EU) 2019/2020

Per Commission Regulation (EU) 2019/2015 and (EU) 2019/2020, the light source contained within this product or its component is intended to be used for Image Capture or Image Projection only, and is not intended for use in other applications.

Regulatory notices for telecommunication terminal equipment

## Regulatory notices for telecommunication terminal equipment

This section contains regulatory information pertaining to products that contain the analog facsimile card:

Lexmark Regulatory Type/Model Number:

LEX-M14-002 or LEX-M03-002

## Notice to users of the US telephone network: FCC requirements

This equipment complies with Part 68 of the FCC rules and the requirements adopted by the Administrative Council for Terminal Attachments (ACTA). On the back of this equipment is a label that contains, among other information, a product identifier in the format US:AAAEQ##TXXXX. If requested, this number must be provided to your telephone company.

This equipment uses the RJ-11C Universal Service Order Code (USOC) jack.

A plug and jack used to connect this equipment to the premises' wiring and telephone network must comply with the applicable FCC Part 68 rules and requirements adopted by the ACTA. Use a compliant telephone cord (RJ-11) that is 26 AWG or larger when connecting this product to the public switched telephone network. See your setup documentation for more information.

The Ringer Equivalence Number (REN) is used to determine the number of devices that may be connected to a telephone line. Excessive RENs on a telephone line may result in the devices not ringing in response to an incoming call. In most but not all areas, the sum of RENs should not exceed five (5.0). To be certain of the number of devices that may be connected to a line, as determined by the total RENs, contact your local telephone company. For products approved after July 23, 2001, the REN for this product is part of the product identifier

that has the format US:AAAEQ##TXXXX. The digits represented by ## are the REN without a decimal point (for example, 03 is a REN of 0.3). For earlier products, the REN is shown separately on the label.

If this equipment causes harm to the telephone network, the telephone company will notify you in advance that temporary discontinuance of service may be required. If advance notice is not practical, the telephone company will notify the customer as soon as possible. You will also be advised of your right to file a complaint with the FCC.

The telephone company may make changes in its facilities, equipment, operations or procedures that could affect the operation of this equipment. If this happens, the telephone company will provide advance notice in order for you to make necessary modifications to maintain uninterrupted service.

If you experience trouble with this equipment, for repair or warranty information, contact Lexmark International, Inc. at [www.lexmark.com](http://www.lexmark.com) or your Lexmark representative. If the equipment is causing harm to the telephone network, the telephone company may request that you disconnect the equipment until the problem is resolved.

This equipment contains no user serviceable parts. For repair and warranty information, contact Lexmark International, Inc. See the previous paragraph for contact information.

Connection to party line service is subject to state tariffs. Contact the state public utility commission, public service commission, or corporation commission for information.

If your home has specially wired alarm equipment connected to the telephone line, ensure the installation of this equipment does not disable your alarm equipment. If you have questions about what will disable alarm equipment, consult your telephone company or a qualified installer.

The Telephone Consumer Protection Act of 1991 makes it unlawful for any person to use a computer or other electronic device, including fax machines, to send any message unless said message clearly contains in a margin at the top or bottom of each transmitted page or on the first page of the transmission, the date and time it is sent and an identification of the business or other entity, or other individual sending the message, and the telephone number of the sending machine or such business, other entity, or individual. (The telephone number provided may not be a 900 number or any other number for which charges exceed local or long-distance transmission charges.)

See your user documentation in order to program this information into your fax machine.

## **Notice to users of the Canadian telephone network**

This product meets the applicable Innovation, Science and Economic Development Canada technical specifications.

The Ringer Equivalence Number (REN) indicates the maximum number of devices allowed to be connected to a telephone interface. The termination of an interface may consist of any combination of devices subject only to the requirement that the sum of the RENs of all the devices not exceed five. The REN is located on the product label.

This equipment uses CA11A telephone jacks.

## **Avis réservé aux utilisateurs du réseau téléphonique du Canada**

Ce produit est conforme aux spécifications techniques d'Innovation, Sciences et Développement économique Canada.

Le numéro REN (ringer equivalence number : numéro d'équivalence de sonnerie) indique le nombre maximum d'appareils pouvant être connectés à l'interface téléphonique. En bout de ligne, le nombre d'appareils qui

peuvent être connectés n'est pas directement limité, mais la somme des REN de ces appareils ne doit pas dépasser cinq. Le numéro REN est indiqué sur l'étiquette produit.

Cet équipement utilise des prises de téléphone CA11A.

Notice to users of the New Zealand telephone network

## **Notice to users of the New Zealand telephone network**

The following are special conditions for the Facsimile User Instructions. The grant of a telepermit for any item of terminal equipment indicates only that Telecom has accepted that the item complies with minimum conditions for connection to its network. It indicates no endorsement of the product by Telecom, nor does it provide any sort of warranty. Above all, it provides no assurance that any item will work correctly in all respects with another item of telepermitted equipment of a different make or model, nor does it imply that any product is compatible with all of Telecom's network services.

This equipment shall not be set up to make automatic calls to the Telecom "111" Emergency Service.

This equipment may not provide for the effective hand-over of a call to another device connected to the same line.

This equipment should not be used under any circumstances that may constitute a nuisance to other Telecom customers.

This equipment is not capable, under all operating conditions, of correct operation at the higher speeds for which it is designed. Telecom will accept no responsibility should difficulties arise in such circumstances.

The decadic (or pulse) dialing on this device is unsuitable for use on the Telecom network in New Zealand.

For correct operation, the total of all the Ringer Equivalence Numbers (RENs) of all parallel devices connected to the same telephone line may not exceed 5. The REN of this device is located on the label.

This device uses an RJ-11C modular connector. Contact your point of purchase if a BT adapter is required. The Lexmark part number is 80D1873.

Some parameters required for compliance with Telecom's telepermit requirements are dependent on the equipment associated with this device. The associated equipment shall be set to operate within the following limits for compliance to Telecom's specifications:

- There shall be no more than 10 call attempts to the same number within any 30 minute period for any single manual call initiation, and
- The equipment shall go on-hook for a period of not less than 30 seconds between the end of one attempt and the beginning of the next call attempt.
- The equipment shall be set to ensure that automatic calls to different numbers are spaced such that there is not less than 5 seconds between the end of one call attempt and the beginning of another.

## **Japanese telecom notice**

The installed optional modem is in compliance with Japanese Telecommunication Law and has been Certified by JATE, with the following Certification Number:

A18-0046001 or A11-0160001



	Lexmark International, Inc.
	LEX-M14-002 or LEX-M03-002
	A18-0046001 or A11-0160001

## Using this product in Switzerland

This product requires a Swiss billing tone filter (Lexmark part number 80D1877) to be installed on any line which receives metering pulses in Switzerland.

## Utilisation de ce produit en Suisse

Cet appareil nécessite l'utilisation d'un filtre de tonalité de facturation suisse (n° de référence Lexmark : 80D1877) devant être installé sur toute ligne recevant des impulsions de comptage en Suisse.

## Verwendung dieses Produkts in der Schweiz

Für dieses Produkt muss ein schweizerischer Billing Tone Filter zur Zählzeichenübertragung (Lexmark Teilenummer 80D1877) für jede Leitung installiert werden, über die in der Schweiz Zeitsteuertakte übertragen werden.

## Uso del prodotto in Svizzera

Questo prodotto richiede un filtro toni Billing svizzero, (codice Lexmark 80D1877) da installare su tutte le linee che ricevono impulsi remoti in Svizzera.

## Regulatory notices for wireless products

This section contains regulatory information that applies only to wireless models.

If in doubt as to whether your model is a wireless model, go to <http://support.lexmark.com>.

## Modular component notice

Wireless-equipped models contain the following modular component(s):

Lexmark Regulatory Type/Model Number: LEX-M07-001; FCC ID: IYLLEXM07001; Industry Canada IC: 2376A-M07001

## Exposure to radio frequency radiation

The radiated output power of this device is far below the radio frequency exposure limits of the FCC and other regulatory agencies. A minimum separation of 20 cm (8 inches) must be maintained between the antenna and any persons for this device to satisfy the RF exposure requirements of the FCC and other regulatory agencies.

## Innovation, Science and Economic Development Canada

This device complies with Innovation, Science and Economic Development Canada license-exempt RSS standards. Operation is subject to the following two conditions: (1) this device may not cause interference, and (2) this device must accept any interference, including interference that may cause undesired operation of the device.

## Innovation, Sciences et Développement économique Canada

Cet appareil est conforme aux normes RSS exemptes de licence d'Innovation, Sciences et Développement économique Canada. Son fonctionnement est soumis aux deux conditions suivantes : (1) cet appareil ne doit pas causer d'interférences et (2) il doit accepter toutes les interférences, y compris les celles qui peuvent entraîner un fonctionnement indésirable.

## European Community (EC) directives conformity

This product is in conformity with the protection requirements of EC Council directive 2014/53/EU on the approximation and harmonization of the laws of the Member States relating to radio equipment.

The manufacturer of this product is: Lexmark International, Inc., 740 West New Circle Road, Lexington, KY, 40550 USA. The EEA/EU authorized representative is: Lexmark International Technology Hungária Kft., 8 Lechner Ödön fasor, Millennium Tower III, 1095 Budapest HUNGARY. The EEA/EU Importer is: Lexmark International Technology S.à.r.l. 20, Route de Pré-Bois, ICC Building, Bloc A, CH-1215 Genève, Switzerland. A declaration of conformity to the requirements of the Directives is available upon request from the Authorized Representative or may be obtained at

[www.lexmark.com/en\\_us/about/regulatory-compliance/european-union-declaration-of-conformity.html](http://www.lexmark.com/en_us/about/regulatory-compliance/european-union-declaration-of-conformity.html).

Compliance is indicated by the CE marking:



## Restrictions

This radio equipment is restricted to indoor use only. Outdoor use is prohibited. This restriction applies to all the countries listed in the table below:



AT	BE	BG	CH	CY	CZ	DE	DK	EE
EL	ES	FI	FR	HR	HU	IE	IS	IT
LI	LT	LU	LV	MT	NL	NO	PL	PT
RO	SE	SI	SK	TR	UK (NI)			

**EU and other countries statement of radio transmitter operational frequency bands and maximum RF power**

This radio product transmits in either the 2.4GHz (2.412–2.472 GHz in the EU) or 5GHz (5.15–5.35, 5.47–5.725 in the EU) bands. The maximum transmitter EIRP power output, including antenna gain, is ≤ 20dBm for both bands.

**United Kingdom (UK) conformity**

This product is in conformity with the protection requirements of the Radio Equipment Regulations 2017.

The manufacturer of this product is: Lexmark International, Inc., 740 West New Circle Road, Lexington, KY, 40550 USA. The UK Importer is: Lexmark International Ltd, Highfield House, Foundation Park - 8 Roxborough Way, Maidenhead Berkshire - SL6 3UD, United Kingdom. A declaration of conformity is available upon request from the UK Importer or may be obtained at [www.lexmark.com/en\\_us/about/regulatory-compliance/uk-declaration-of-conformity.html](http://www.lexmark.com/en_us/about/regulatory-compliance/uk-declaration-of-conformity.html).

Compliance is indicated by the UKCA marking:



**Restrictions or requirements in the UK**

This radio equipment is restricted to indoor use only. Outdoor use is prohibited.

**UK statement of radio transmitter operational frequency bands and maximum RF power**

This radio product transmits in either the 2.4GHz (2.412–2.472 GHz in the UK) or 5GHz (5.15–5.35, 5.47–5.725 in the UK) bands. The maximum transmitter EIRP power output, including antenna gain, is ≤ 20dBm for both bands.

## **Federal Communications Commission (FCC) compliance information statement**

This product has been tested and found to comply with the limits for a Class A digital device, pursuant to Part 15 of the FCC Rules. Operation is subject to the following two conditions: (1) this device may not cause harmful interference, and (2) this device must accept any interference received, including interference that may cause undesired operation.

The FCC Class A limits are designed to provide reasonable protection against harmful interference when the equipment is operated in a commercial environment. This equipment generates, uses, and can radiate radio frequency energy and, if not installed and used in accordance with the instruction manual, may cause harmful interference to radio communications. Operation of this equipment in a residential area is likely to cause harmful interference, in which case the user will be required to correct the interference at his own expense.

The manufacturer is not responsible for any radio or television interference caused by using other than recommended cables or by unauthorized changes or modifications to this equipment. Unauthorized changes or modifications could void the user's authority to operate this equipment.

**Note:** To assure compliance with FCC regulations on electromagnetic interference for a Class A computing device, use a properly shielded and grounded cable such as Lexmark part number 1021231 for parallel attach or 1021294 for USB attach. Use of a substitute cable not properly shielded and grounded may result in a violation of FCC regulations.

Any questions regarding this compliance information statement should be directed to:

Director of Lexmark Technology & Services  
Lexmark International, Inc.  
740 West New Circle Road  
Lexington, KY 40550  
Telephone: (859) 232-2000  
E-mail: regulatory@lexmark.com

## **Innovation, Science and Economic Development Canada compliance statement**

This Class A digital apparatus meets all requirements of the Canadian Interference-Causing Equipment Standard ICES-003.

## **Avis de conformité aux normes de l'Innovation, Sciences et Développement économique Canada**

Cet appareil numérique de classe A est conforme aux exigences de la norme canadienne relative aux équipements pouvant causer des interférences NMB-003.

## Japanese VCCI notice

製品にこのラベルが表示されている場合、  
次の要件を満たしています。

この装置は、クラス A 情報技術装置です。この装置を家庭環境で使用すると電波妨害を引き起こすことがあります。この場合には使用者が適切な対策を講ずるよう要求されることがあります。 VCCI-A

この装置は、クラスA情報技術装置です。この装置を家庭環境で使用すると電波妨害を引き起こすことがあります。この場合には使用者が適切な対策を講ずるよう要求されることがあります。 VCCI-A

## Aviso aos usuários de produtos Classe A no Brasil.

Este produto não é apropriado para uso em ambientes domésticos, pois poderá causar interferências eletromagnéticas que obrigam o usuário a tomar medidas necessárias para minimizar estas interferências.

## European Community (EC) directives conformity

This product is in conformity with the protection requirements of EC Council directives 2014/30/EU, 2014/35/EU, and 2011/65/EU as amended by (EU) 2015/863 on the approximation and harmonization of the laws of the Member States relating to electromagnetic compatibility, safety of electrical equipment designed for use within certain voltage limits, and on the restrictions of use of certain hazardous substances in electrical and electronic equipment.

The manufacturer of this product is: Lexmark International, Inc., 740 West New Circle Road, Lexington, KY, 40550 USA. The EEA/EU authorized representative is: Lexmark International Technology Hungária Kft., 8 Lechner Ödön fasor, Millennium Tower III, 1095 Budapest HUNGARY. The EEA/EU Importer is: Lexmark International Technology S.à.r.l. 20, Route de Pré-Bois, ICC Building, Bloc A, CH-1215 Genève, Switzerland. A declaration of conformity to the requirements of the Directives is available upon request from the Authorized Representative or may be obtained at [www.lexmark.com/en\\_us/about/regulatory-compliance/european-union-declaration-of-conformity.html](http://www.lexmark.com/en_us/about/regulatory-compliance/european-union-declaration-of-conformity.html).

This product satisfies the Class A limits of EN 55032 and safety requirements of EN 62368-1.

## United Kingdom (UK) conformity

This product is in conformity with the protection requirements of the Electromagnetic Compatibility Regulations 2016, the Electrical Equipment (Safety) Regulations 2016, and the Restriction of the Use of Certain Hazardous Substances in Electrical and Electronic Equipment Regulations 2012.

The manufacturer of this product is: Lexmark International, Inc., 740 West New Circle Road, Lexington, KY, 40550 USA. The UK Importer is: Lexmark International Ltd, Highfield House, Foundation Park - 8 Roxborough Way, Maidenhead Berkshire - SL6 3UD, United Kingdom. A declaration of conformity is available upon request from the UK Importer or may be obtained at [www.lexmark.com/en\\_us/about/regulatory-compliance/uk-declaration-of-conformity.html](http://www.lexmark.com/en_us/about/regulatory-compliance/uk-declaration-of-conformity.html).

This product satisfies the Class A limits of BS EN 55032 and safety requirements of BS EN 62368-1.

## Radio interference notice

### Warning

This is a product that complies with the emission requirements of EN 55032 Class A limits and immunity requirements of EN 55024. This product is not intended to be used in residential/domestic environments.

This is a Class A product. In a domestic environment, this product may cause radio interference, in which case the user may be required to take adequate measures.

STATEMENT OF LIMITED WARRANTY FOR LEXMARK LASER PRINTERS, LEXMARK LED PRINTERS, AND LEXMARK MULTIFUNCTION LASER PRINTERS

## STATEMENT OF LIMITED WARRANTY FOR LEXMARK LASER PRINTERS, LEXMARK LED PRINTERS, AND LEXMARK MULTIFUNCTION LASER PRINTERS

### Lexmark International, Inc., Lexington, KY

This limited warranty applies to the United States and Canada. For customers outside the U.S., refer to the country-specific warranty information that came with your product.

This limited warranty applies to this product only if it was originally purchased for your use, and not for resale, from Lexmark or a Lexmark Remarketer, referred to in this statement as “Remarketer.”

### Limited warranty

Lexmark warrants that this product:

- Is manufactured from new parts, or new and serviceable used parts, which perform like new parts
- Is, during normal use, free from defects in material and workmanship

If this product does not function as warranted during the warranty period, contact a Remarketer or Lexmark for repair or replacement (at Lexmark's option).

If this product is a feature or option, this statement applies only when that feature or option is used with the product for which it was intended. To obtain warranty service, you may be required to present the feature or option with the product.

If you transfer this product to another user, warranty service under the terms of this statement is available to that user for the remainder of the warranty period. You should transfer proof of original purchase and this statement to that user.

### Limited warranty service

The warranty period starts on the date of original purchase as shown on the purchase receipt and ends 12 months later provided that the warranty period for any supplies and for any maintenance items included with the printer shall end earlier if it, or its original contents, are substantially used up, depleted, or consumed. Fuser Units, Transfer/Transport Units, Paper Feed items, if any, and any other items for which a Maintenance Kit is available are substantially consumed when the printer displays a “Life Warning” or “Scheduled Maintenance” message for such item.

To obtain warranty service you may be required to present proof of original purchase. You may be required to deliver your product to the Remarketer or Lexmark, or ship it prepaid and suitably packaged to a Lexmark designated location. You are responsible for loss of, or damage to, a product in transit to the Remarketer or the Lexmark designated location.

When warranty service involves the exchange of a product or part, the item replaced becomes the property of the Remarketer or Lexmark. The replacement may be a new or repaired item.

The replacement item assumes the remaining warranty period of the original product.

Replacement is not available to you if the product you present for exchange is defaced, altered, in need of a repair not included in warranty service, damaged beyond repair, or if the product is not free of all legal obligations, restrictions, liens, and encumbrances.

As part of your warranty service and/or replacement, Lexmark may update the firmware in your printer to the latest version. Firmware updates may modify printer settings and cause counterfeit and/or unauthorized products, supplies, parts, materials (such as toners and inks), software, or interfaces to stop working. Authorized use of genuine Lexmark products will not be impacted.

Before you present this product for warranty service, remove all print cartridges, programs, data, and removable storage media (unless directed otherwise by Lexmark).

For further explanation of your warranty alternatives and the nearest Lexmark authorized servicer in your area contact Lexmark on the World Wide Web.

Remote technical support is provided for this product throughout its warranty period. For products no longer covered by a Lexmark warranty, technical support may not be available or only be available for a fee.

### **Extent of limited warranty**

Lexmark does not warrant uninterrupted or error-free operation of any product or the durability or longevity of prints produced by any product.

Warranty service does not include repair of failures caused by:

- Modification or unauthorized attachments
- Accidents, misuse, abuse or use inconsistent with Lexmark user's guides, manuals, instructions or guidance
- Unsuitable physical or operating environment
- Maintenance by anyone other than Lexmark or a Lexmark authorized servicer
- Operation of a product beyond the limit of its duty cycle
- Use of printing media outside of Lexmark specifications
- Refurbishment, repair, refilling or remanufacture by a third party of products, supplies or parts
- Products, supplies, parts, materials (such as toners and inks), software, or interfaces not furnished by Lexmark

**TO THE EXTENT PERMITTED BY APPLICABLE LAW, NEITHER LEXMARK NOR ITS THIRD PARTY SUPPLIERS OR REMARKETERS MAKE ANY OTHER WARRANTY OR CONDITION OF ANY KIND, WHETHER EXPRESS OR IMPLIED, WITH RESPECT TO THIS PRODUCT, AND SPECIFICALLY DISCLAIM THE IMPLIED WARRANTIES OR CONDITIONS OF MERCHANTABILITY, FITNESS FOR A PARTICULAR PURPOSE, AND SATISFACTORY QUALITY. ANY WARRANTIES THAT MAY NOT BE DISCLAIMED UNDER APPLICABLE LAW ARE LIMITED IN DURATION TO THE WARRANTY PERIOD. NO WARRANTIES, EXPRESS OR IMPLIED, WILL APPLY AFTER THIS PERIOD. ALL INFORMATION, SPECIFICATIONS, PRICES, AND SERVICES ARE SUBJECT TO CHANGE AT ANY TIME WITHOUT NOTICE.**

### **Limitation of liability**

Your sole remedy under this limited warranty is set forth in this document. For any claim concerning performance or nonperformance of Lexmark or a Remarketer for this product under this limited warranty, you may recover actual damages up to the limit set forth in the following paragraph.

Lexmark's liability for actual damages from any cause whatsoever will be limited to the amount you paid for the product that caused the damages. This limitation of liability will not apply to claims by you for bodily injury or damage to real property or tangible personal property for which Lexmark is legally liable. **IN NO EVENT WILL LEXMARK BE LIABLE FOR ANY LOST PROFITS, LOST SAVINGS, INCIDENTAL DAMAGE, OR OTHER ECONOMIC OR CONSEQUENTIAL DAMAGES.** This is true even if you advise Lexmark or a Remarketer of the possibility of such damages. Lexmark is not liable for any claim by you based on a third party claim.

This limitation of remedies also applies to claims against any Suppliers and Remarketers of Lexmark. Lexmark's and its Suppliers' and Remarketers' limitations of remedies are not cumulative. Such Suppliers and Remarketers are intended beneficiaries of this limitation.

### **Additional rights**

Some states do not allow limitations on how long an implied warranty lasts, or do not allow the exclusion or limitation of incidental or consequential damages, so the limitations or exclusions contained above may not apply to you.

This limited warranty gives you specific legal rights. You may also have other rights that vary from state to state.



# Index

## Numerics

- 2100-sheet tray
  - installing 310
  - loading 33
- 4-bin mailbox
  - installing 313

## A

- accessing the controller board 297
- activating Voice Guidance 28
- adapter plug 72
- adding a shortcut copy 56
- adding contacts 26
- adding groups 26
- adding hardware options
  - print driver 320
- adding internal options
  - print driver 320
- adding printers to a computer 319
- adding shortcut e-mail 65
  - fax destination 75
  - FTP address 80
- ADF feed roller
  - cleaning 183
  - replacing 205
- ADF pick roller
  - cleaning 181
  - replacing 202
- ADF registration
  - adjusting 295
- ADF separator roller
  - replacing 208
- ADF torque limiter
  - replacing 211
- adjusting
  - scanner registration 295
- adjusting ADF registration 295
- adjusting default volume
  - headphone 169
- adjusting fax darkness 76
- adjusting speech rate
  - Voice Guidance 28
- adjusting the brightness
  - printer display 219

- adjusting the brightness of the printer display 219
- adjusting toner darkness 270
- AirPrint
  - using 48
- analog fax
  - setting up 67
- answering machine
  - setting up 70
- applications, supported 21
- assigning printer to a ring pattern 74
- attaching cables 17
- automatic document feeder (ADF)
  - using 54, 57, 66, 78
- avoiding paper jams 221

## B

- blank pages 242
- blocking junk faxes 76
- bookmarks
  - creating 25
  - creating folders for 26

## C

- canceling a print job
  - from the computer 52
  - from the printer control panel 52
- cannot connect printer to Wi-Fi 274
- cannot open Embedded Web Server 273
- cannot receive faxes using analog fax 286
- cannot scan to a network folder 290
- cannot send e-mails 283
- cannot send or receive faxes using analog fax 284
- cannot send or receive faxes using etherFAX 287
- cannot send the fax cover page from the computer 288
- Card Copy
  - setting up 21

- changing resolution
  - fax 76
- changing the printer port settings after installing ISP 172
- changing the wallpaper 22
- checking the printer connectivity 275
- checking the status of parts and supplies 188
- cleaning
  - exterior of the printer 173
  - interior of the printer 173
  - pick tires 177
- cleaning pick roller in the multipurpose feeder 178
- cleaning the ADF feed roller 183
- cleaning the ADF pick roller 181
- cleaning the printer 173
- Cleaning the Scanner 164
- cleaning the scanner 174
- cleaning the touch screen 174
- clearing jam
  - automatic document feeder 229
  - in door A 224
  - in door H 232
  - in door N 231
  - in mailbox bin 231
  - in the duplex unit 226
  - in the fuser 226
  - in the multipurpose feeder 228
  - in the offset stacker bin 232
  - in the staple finisher 235
  - in the staple finisher bin 232
  - in the staple, hole punch finisher 233
  - in the staple, hole punch finisher bin 233
  - in trays 223
- clearing staple jam
  - in the staple, hole punch finisher 238
- Cloud Connector profile
  - creating 24
  - printing from 52
  - scanning to 81
- collated printing does not work 279

- collating copies 55
- computer
  - connecting to the printer 171
- computer, scanning to 78
- confidential documents do not print 271
- confidential print jobs 50
  - printing 51
- configuring daylight saving time 74
- configuring fax speaker settings 169
- configuring supply notifications 168
- configuring the e-mail server settings 57
- configuring Wi-Fi Direct 171
- connecting a computer to the printer 171
- connecting mobile device to printer 171
- connecting printer to distinctive ring service 74
- connecting the printer to a wireless network 169
- connecting to a wireless network
  - using PIN method 170
  - using Push Button method 170
- conserving supplies 219
- contacting customer support 296
- contacts
  - adding 26
  - deleting 27
  - editing 27
- control panel
  - using 18
- controller board
  - accessing 297
- copy troubleshooting
  - partial copies of documents or photos 291
  - poor copy quality 292
  - scanner does not respond 295
- copying
  - on both sides of the paper 55
  - on letterhead 55
  - photos 54
  - using the automatic document feeder (ADF) 54
  - using the scanner glass 54
- copying different paper sizes 54

- copying from
  - selected tray 54
- copying multiple pages
  - onto a single sheet 56
- creating a Cloud Connector profile 24
- creating a shortcut
  - copy 56
- creating bookmarks 25
- creating folders
  - for bookmarks 26
- creating shortcut e-mail 65
- fax destination 75
- FTP address 80
- creating shortcuts 22
- crooked print 253
- Customer Support
  - using 24
- customer support
  - contacting 296
- customizing the display 22

**D**

- dark print 244
- date and time
  - fax settings 74
- daylight saving time
  - configuring 74
- deactivating the Wi-Fi network 172
- default headphone volume
  - adjusting 169
- Defective flash detected 276
- deleting contacts 27
- deleting groups 27
- Device Quotas
  - setting up 23
- different paper sizes, copying 54
- directory list
  - printing 52
- Display Customization
  - using 22
- distinctive ring service, fax
  - enabling 74
- documents, printing
  - from a computer 47
  - from a mobile device 47

**E**

- Eco-Settings
  - configuring 24
- editing contacts 27
- editing groups 27
- emission notices 325, 334, 337
- emptying the hole punch box 186
- enabling Magnification mode 28
- enabling personal identification numbers 29
- enabling spoken passwords 29
- enabling the USB port 273
- enabling Wi-Fi Direct 171
- encrypting
  - printer hard disk 166
- enlarging copies 55
- envelopes
  - loading 38
- environmental settings 218
- erasing
  - printer memory 165
  - erasing hard disk memory 165
  - erasing printer memory 166
- etherFAX
  - setting up fax function 68
- Ethernet cable 17
- Ethernet port 17
- exporting a configuration file
  - using the Embedded Web Server 321
- EXT port 17
- e-mail
  - sending 65
- e-mail alerts
  - setting up 168
- e-mail function
  - setting up 57
- e-mail server
  - configuring 57
- e-mail service providers 57
- e-mail shortcut
  - creating 65
- e-mail troubleshooting
  - cannot send e-mails 283
- e-mailing
  - using the automatic document feeder (ADF) 57
  - using the scanner glass 57

**F**

- factory default settings
  - restoring 166
- fax
  - forwarding 77
  - holding 76
  - scheduling send time and date 75
  - sending 74
- fax darkness
  - adjusting 76
- fax destination shortcut
  - creating 75
- fax driver
  - installing 319
- fax log
  - viewing 76
- fax resolution
  - changing 76
- fax server, using
  - setting up the fax function 69
- fax setup
  - country- or region-specific 72
  - standard telephone line connection 70
- fax speaker settings
  - configuring 169
- fax troubleshooting
  - caller ID is not shown 284
  - can send but not receive faxes
    - using analog fax 286
  - cannot send faxes using analog fax 286
  - cannot send or receive faxes
    - using analog fax 284
  - cannot send or receive faxes
    - using etherFAX 287
  - cannot send the fax cover page
    - from the computer 288
  - cannot set up etherFAX 286
  - missing information on the fax cover page 288
  - poor print quality 287
- faxing
  - setting the date and time 74
  - using the automatic document feeder (ADF) 66
  - using the scanner glass 66
- FCC notices 334
- finding information about the printer 11

- finding the printer serial number 12
- firmware, updating
  - using the control panel 321
  - using the Embedded Web Server 322
- flash drive
  - printing from 49
  - scanning to 80
- folder paper 246
- font sample list
  - printing 52
- forwarding fax 77
- FTP address
  - creating shortcut 80
- FTP server, scanning to
  - using the control panel 79
- fuser
  - replacing 195

**G**

- genuine Lexmark parts and supplies 188
- gray background on prints 247
- groups
  - adding 26
  - deleting 27
  - editing 27

**H**

- hard disk memory
  - erasing 165
- hardware options
  - installing 310, 313, 314, 315, 317
  - memory card 299
  - trays 309
- hardware options, adding
  - print driver 320
- held documents do not print 271
- held jobs 50
  - printing 51
- Help menu 163
- Hibernate mode
  - configuring 218
- holding faxes 76
- hole punch box
  - emptying 186
- home screen
  - customizing 21
- home screen icons
  - displaying 21

- using 20
- humidity around the printer 328

**I**

- icons on the home screen
  - showing 21
- identifying jam locations 222
- imaging unit
  - ordering 190
  - replacing 193
- importing a configuration file
  - using the Embedded Web Server 321
- incorrect margins 249
- indicator light
  - understanding the status 18
- installing a memory card 299
- installing internal solutions
  - port 305
- installing optional card 301
- installing options
  - printer hard disk 303
- installing the 2100-sheet tray 310
- installing the 4-bin mailbox 313
- installing the fax driver 319
- installing the offset stacker 314
- installing the print driver 319
- installing the printer software 319
- installing the staple finisher 315
- installing the staple, hole punch finisher 317
- installing trays 309
- internal option is not detected 276
- internal options
  - firmware card 297
  - flash memory 297
  - font card 297
  - internal solutions port 297
  - printer hard disk 297, 303
- internal options, adding
  - print driver 320
- internal solutions port
  - installing 305

**J**

- jagged image
  - scanning from the ADF 293
- jagged text
  - scanning from the ADF 293

jams  
  avoiding 221  
jams, clearing  
  in the standard bin 227  
junk faxes  
  blocking 76

## K

keyboard on the display  
  using 29

## L

letterhead  
  copying on 55  
  loading 38  
  loading, 2100-sheet tray 33  
Lexmark Mobile Print  
  using 47  
Lexmark ScanBack Utility 78  
light print 250  
LINE port 17  
linking trays 39  
loading  
  2100-sheet tray 33  
  letterhead in 2100-sheet  
  tray 33  
loading the multipurpose  
feeder 38  
loading trays 30  
locating jam areas 222  
locating the security slot 165

## M

Magnification mode  
  enabling 28  
maintenance kit  
  ordering 190  
making copies 54  
managing screen saver 22  
memory card  
  installing 299  
menu  
  802.1x 151  
  About this Printer 96  
  Accessibility 90  
  Anonymous Data Collection 89  
  Bin Configuration 108  
  Confidential Print Setup 159  
  Configuration Menu 91  
  Copy Defaults 109  
  Custom Scan Sizes 107

  Device 162  
  Disk Encryption 160  
  Eco-Mode 84  
  Erase Temporary Data Files 161  
  Ethernet 147  
  E-mail Defaults 127  
  E-mail Setup 126  
  Fax 163  
  Fax Mode 113  
  Fax Server Setup 123  
  Fax Setup 113  
  Finishing 98  
  Flash Drive Print 141  
  Flash Drive Scan 137  
  FTP Defaults 132  
  HTML 105  
  HTTP/FTP Settings 152  
  Image 105  
  IPSec 150  
  Job Accounting 101  
  Layout 97  
  Local Accounts 156  
  Login Restrictions 159  
  LPD Configuration 151  
  Manage Permissions 155  
  Media Types 108  
  Menu Settings Page 162  
  Miscellaneous 161  
  Network 163  
  Network Overview 143  
  Notifications 86  
  Out of Service Erase 95  
  PCL 103  
  PDF 102  
  PostScript 102  
  Power Management 89  
  Preferences 83  
  Print 162  
  Quality 100  
  Remote Operator Panel 85  
  Restore Factory Defaults 91  
  Restrict external network  
  access 154  
  Schedule USB Devices 156  
  Security Audit Log 157  
  Setup 99  
  Shortcuts 163  
  SNMP 149  
  Solutions LDAP Settings 161  
  TCP/IP 148  
  ThinPrint 153  
  Tray Configuration 106

  Troubleshooting 164  
  Universal Setup 106  
  USB 153  
  Visible Home Screen Icons 96  
  Web Link Setup 132  
  Wireless 144  
  Wi-Fi Direct 146  
  XPS 102  
Menu Settings Page  
  printing 164  
missing information on the fax  
cover page 288  
mobile device  
  connecting to printer 171  
  printing from 47, 48  
Mopria Print Service 47  
moving the printer 13, 217  
multipurpose feeder  
  loading 38

## N

navigating the screen  
  using gestures 28  
navigating the screen using  
gestures 28  
noise emission levels 325  
nonvolatile memory  
  erasing 165  
Non-Lexmark supply 278  
non-volatile memory 166  
Not enough free space in flash  
memory for resources 277  
notices 325, 326, 328, 329,  
330, 333, 334, 337

## O

offset stacker  
  installing 314  
operating systems  
  supported 318  
optional card  
  installing 301  
ordering  
  maintenance kit 190  
ordering supplies  
  imaging unit 190  
  staple cartridge 190  
  toner cartridge 188

**P**

- paper
  - Universal size setting 30
- paper curl 280
- paper jam
  - in the duplex area 226
  - in the fuser 226
- paper jam in door A 224
- paper jam in door C 226
- paper jam in door H 232
- paper jam in door N 231
- paper jam in the 4-bin mailbox 231
- paper jam in the automatic document feeder 229
- paper jam in the multipurpose feeder 228
- paper jam in the offset stacker bin 232
- paper jam in the staple finisher bin 232
- paper jam in trays 223
- paper jam, clearing
  - automatic document feeder 229
- paper jams
  - avoiding 221
  - location 222
- paper jams, clearing
  - in the standard bin 227
- paper size
  - setting 30
- paper type
  - setting 30
- paper types
  - supported 43
- parts status
  - checking 188
- personal identification number method 170
- personal identification numbers
  - enabling 29
- photos, copying 54
- pick roller
  - replacing 199
- pick roller in the multipurpose feeder
  - cleaning 178
  - replacing 201
- pick tires
  - cleaning 177
- placing separator sheets
  - between copies
    - copying 55
- poor fax print quality 287
- power button light
  - understanding the status 18
- power cord socket 17
- power save modes
  - configuring 218
- prepunched paper
  - loading 38
- print driver
  - hardware options, adding 320
  - installing 319
- print job
  - canceling from the computer 52
  - canceling from the printer control panel 52
- print jobs not printed 267
- print quality
  - cleaning the scanner 174
- print quality problem
  - gray background on prints 247
- print quality problems 241
- Print Quality Test Pages 164
- print quality troubleshooting
  - blank or white pages 242
  - crooked print 253
  - dark print 244
  - fine lines are not printed correctly 245
  - folded or wrinkled paper 246
  - horizontal light bands 259
  - light print 250
  - mottled print and dots 252
  - paper curl 280
  - print quality problems 241
  - repeating defects 266
  - skewed print 253
  - solid black pages 253
  - text or images cut off 255
  - toner easily rubs off 258
  - vertical dark bands 261
  - vertical dark lines 263
  - vertical dark lines or streaks 264
  - vertical dark streaks with print missing 265
  - vertical light bands 259
  - vertical white lines 260
- print troubleshooting
  - collated printing does not work 279
  - confidential and other held documents do not print 271
  - envelope seals when printing 279
  - incorrect margins 249
  - jammed pages are not reprinted 283
  - job prints from the wrong tray 270
  - job prints on the wrong paper 270
  - paper frequently jams 282
  - print jobs do not print 267
  - slow printing 268
  - tray linking does not work 281
  - unable to read flash drive 273
- printer
  - minimum clearances 13
  - selecting a location 13
  - shipping 218
- printer configurations 14
- printer display
  - adjusting the brightness 219
- printer hard disk
  - encrypting 166
  - installing 303
- printer hard disk memory 166
- printer information
  - finding 11
- printer is not responding 272
- printer memory
  - erasing 165
- printer menus 82
- printer messages
  - Defective flash detected 276
  - Non-Lexmark supply 278
  - Not enough free space in flash memory for resources 277
  - Replace cartridge, printer region mismatch 277
  - Unformatted flash detected 277
- printer options troubleshooting
  - cannot detect internal option 276
- printer port settings
  - changing 172
- printer ports 17
- printer settings
  - restoring factory default 166

printer software  
 installing 319  
 printer status 18  
 printing  
 confidential print jobs 51  
 directory list 52  
 font sample list 52  
 from a Cloud Connector  
 profile 52  
 from a computer 47  
 from a flash drive 49  
 from a mobile device 47, 48  
 held jobs 51  
 Menu Settings Page 164  
 using Mopria Print Service 47  
 using Wi-Fi Direct 48  
 printing a directory list 52  
 printing a font sample list 52  
 printing a network setup  
 page 275  
 printing from a computer 47  
 printing from a flash drive 49  
 Push Button method 170

## Q

QR codes  
 adding 24

## R

recycling  
 Lexmark packaging 219  
 Lexmark products 219  
 reducing copies 55  
 removing paper jam  
 in door A 224  
 in door H 232  
 in door N 231  
 in mailbox bin 231  
 in the duplex unit 226  
 in the fuser 226  
 in the multipurpose feeder 228  
 in the offset stacker bin 232  
 in the staple finisher bin 232  
 in the staple, hole punch  
 finisher 233  
 in the staple, hole punch  
 finisher bin 233  
 in trays 223  
 removing staple jam 235, 238  
 repeat print jobs 50

Replace cartridge, printer region  
 mismatch 277  
 replacing  
 pick roller in the multipurpose  
 feeder 201  
 replacing parts  
 ADF pick roller 202  
 ADF separator roller 208  
 ADF torque limiter 211  
 fuser 195  
 pick roller 199  
 transfer roller 197  
 replacing supplies  
 imaging unit 193  
 staple cartridge 214, 216  
 toner cartridge 192  
 replacing the ADF feed  
 roller 205  
 replacing the ADF separator  
 roller 208  
 reports  
 printer status 168  
 printer usage 168  
 resetting  
 supply usage counters 278  
 resetting supply usage  
 counters 217  
 resetting the supply usage  
 counters 278  
 RJ-11 adapter 72  
 running a slideshow 22

## S

safety information 8, 9, 10  
 saving paper 56  
 saving toner 56  
 Scan Center  
 setting up 23  
 scan troubleshooting  
 cannot scan to a computer 289  
 cannot scan to network  
 folder 290  
 jagged image when scanning  
 from the ADF 293  
 jagged text when scanning from  
 the ADF 293  
 partial copies of documents or  
 photos 291  
 poor copy quality 292  
 scan job was not  
 successful 293  
 scanner does not respond 295

scanning freezes the  
 computer 294  
 scanning takes too long 294  
 vertical dark streaks on output  
 when scanning from the  
 ADF 292  
 scanner  
 cleaning 174  
 scanner does not close 294  
 scanner glass  
 using 54, 57, 66, 78  
 scanning  
 to a Cloud Connector profile 81  
 to a computer 78  
 to an FTP server 79  
 to flash drive 80  
 using the automatic document  
 feeder (ADF) 78  
 using the scanner glass 78  
 scanning from ADF  
 jagged image 293  
 jagged text 293  
 scanning quality problem 292  
 scanning to a network folder 80  
 scanning to an FTP server  
 using the control panel 79  
 scheduling a fax 75  
 securing printer memory 166  
 security slot  
 locating 165  
 selecting a location for the  
 printer 13  
 sending e-mail 65  
 sending fax 74  
 serial number, printer  
 finding 12  
 serial printing  
 setting up 173  
 setting the paper size 30  
 setting the paper type 30  
 setting the Universal paper  
 size 30  
 setting up  
 analog fax 67  
 setting up Device Quotas 23  
 setting up e-mail alerts 168  
 setting up fax  
 country- or region-specific 72  
 standard telephone line  
 connection 70  
 setting up fax function  
 using etherFAX 68

- setting up serial printing 173
  - setting up the fax function using fax server 69
  - shipping the printer 218
  - shortcut
    - Copy 22
    - Email 22
    - Fax 22
    - FTP 22
  - shortcut, creating
    - e-mail 65
    - fax destination 75
    - FTP address 80
  - shortcut, creating a copy 56
  - shortcuts
    - creating 22
  - skewed print 253
  - Sleep mode
    - configuring 218
  - slow printing 268
  - SMB
    - scanning 80
  - SMTP settings
    - configuring 57
  - sorting multiple copies 55
  - spoken passwords
    - enabling 29
  - staple cartridge
    - ordering 190
    - replacing 214, 216
  - staple finisher
    - installing 315
  - staple, hole punch finisher
    - installing 317
  - statement of volatility 166
  - storing print jobs 50
  - supplies
    - conserving 219
  - supplies status
    - checking 188
  - supply notifications
    - configuring 168
  - supply usage counters
    - resetting 217, 278
  - supported applications 21
  - supported fax 67
  - supported file types 50
  - supported flash drives 50
  - supported operating systems 318
  - supported paper sizes 40
  - supported paper types 43
  - supported paper weights 44
- T**
- temperature around the printer 328
  - toner cartridge
    - ordering 188
    - replacing 192
  - toner darkness
    - adjusting 270
  - touch screen
    - cleaning 174
  - transfer roller
    - replacing 197
  - trays
    - linking 39
    - loading 30
    - unlinking 39
  - troubleshooting
    - cannot connect printer to Wi-Fi 274
    - cannot open Embedded Web Server 273
    - print quality problems 241
    - printer is not responding 272
  - troubleshooting, copy
    - partial copies of documents or photos 291
    - poor copy quality 292
    - scanner does not close 294
    - scanner does not respond 295
  - troubleshooting, e-mail
    - cannot send e-mails 283
  - troubleshooting, fax
    - caller ID is not shown 284
    - can send but not receive faxes using analog fax 286
    - cannot send faxes using analog fax 286
    - cannot send or receive faxes using analog fax 284
    - cannot send or receive faxes using etherFAX 287
    - cannot send the fax cover page from the computer 288
    - cannot set up etherFAX 286
    - missing information on the fax cover page 288
    - poor print quality 287
  - troubleshooting, print
    - collated printing does not work 279
    - confidential and other held documents do not print 271
    - envelope seals when printing 279
    - incorrect margins 249
    - jammed pages are not reprinted 283
    - job prints from the wrong tray 270
    - job prints on the wrong paper 270
    - paper frequently jams 282
    - print jobs do not print 267
    - slow printing 268
    - tray linking does not work 281
  - troubleshooting, print quality
    - blank or white pages 242
    - crooked print 253
    - dark print 244
    - fine lines are not printed correctly 245
    - folded or wrinkled paper 246
    - horizontal light bands 259
    - light print 250
    - mottled print and dots 252
    - paper curl 280
    - repeating defects 266
    - skewed print 253
    - solid black pages 253
    - text or images cut off 255
    - toner easily rubs off 258
    - vertical dark bands 261
    - vertical dark lines 263
    - vertical dark lines or streaks 264
    - vertical dark streaks with print missing 265
    - vertical light bands 259
    - vertical white lines 260
  - troubleshooting, printer options
    - cannot detect internal option 276
  - troubleshooting, scan
    - cannot scan to a computer 289
    - cannot scan to a network folder 290
    - jagged image when scanning from the ADF 293

- jagged text when scanning from the ADF 293
- partial copies of documents or photos 291
- poor copy quality 292
- scan job was not successful 293
- scanner does not close 294
- scanner does not respond 295
- vertical dark streaks on output when scanning from the ADF 292
- two-sided copying 55

## U

- unable to read flash drive troubleshooting, print 273
- Unformatted flash detected 277
- Universal paper size setting 30
- unlinking trays 39
- updating firmware
  - using the control panel 321
  - using the Embedded Web Server 322
- USB cable 17
- USB port 17
  - enabling 273
- using Customer Support 24
- using Display Customization 22
- using genuine Lexmark parts and supplies 188
- using QR Code Generator 24
- using the ADF
  - copying 54
- using the automatic document feeder (ADF) 54, 57, 66, 78
  - using the control panel 18
  - using the home screen 20
- using the scanner
  - glass 54, 57, 66, 78
    - copying 54

## V

- verify print jobs 50
- vertical dark lines 263
- vertical dark lines on prints 264
- vertical dark streaks on output when scanning from the ADF 292
- vertical streaks on prints 264

- viewing a fax log 76
- viewing reports 168
- virtual keyboard
  - using 29
- Voice Guidance
  - activating 28
  - speech rate 28
- Voice Guidance speech rate
  - adjusting 28
- volatile memory 166
  - erasing 165

## W

- white lines 260
- white pages 242
- wireless network
  - connecting the printer to 169
    - Wi-Fi Protected Setup 170
- wireless networking 169
- Wi-Fi Direct
  - configuring 171
  - enabling 171
  - printing from a mobile device 48
- Wi-Fi network
  - deactivating 172
- Wi-Fi Protected Setup
  - wireless network 170
- wrinkled paper 246