

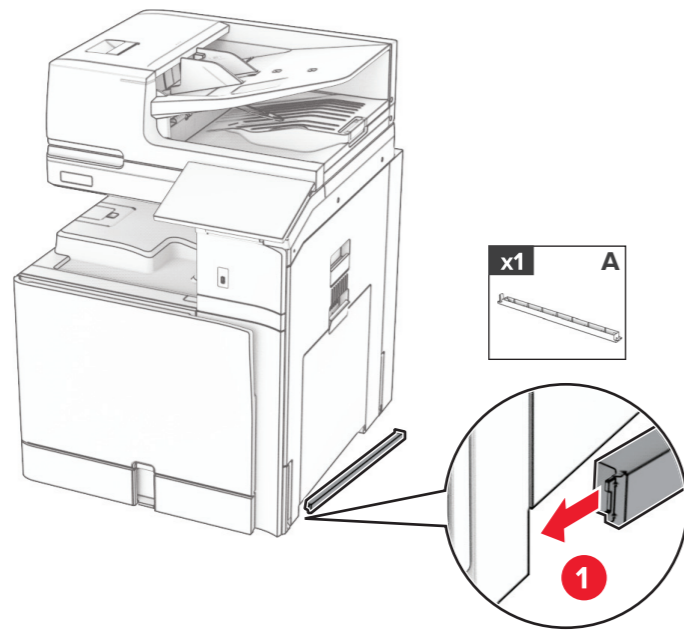

10



11



12

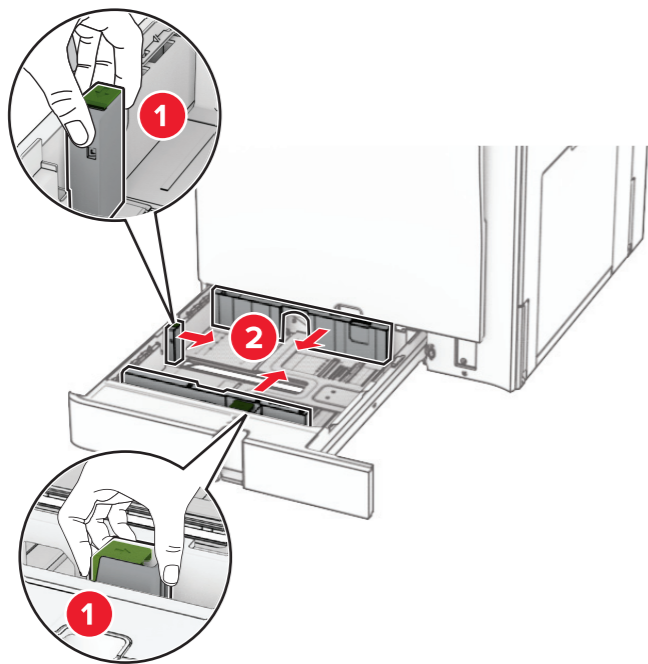

13

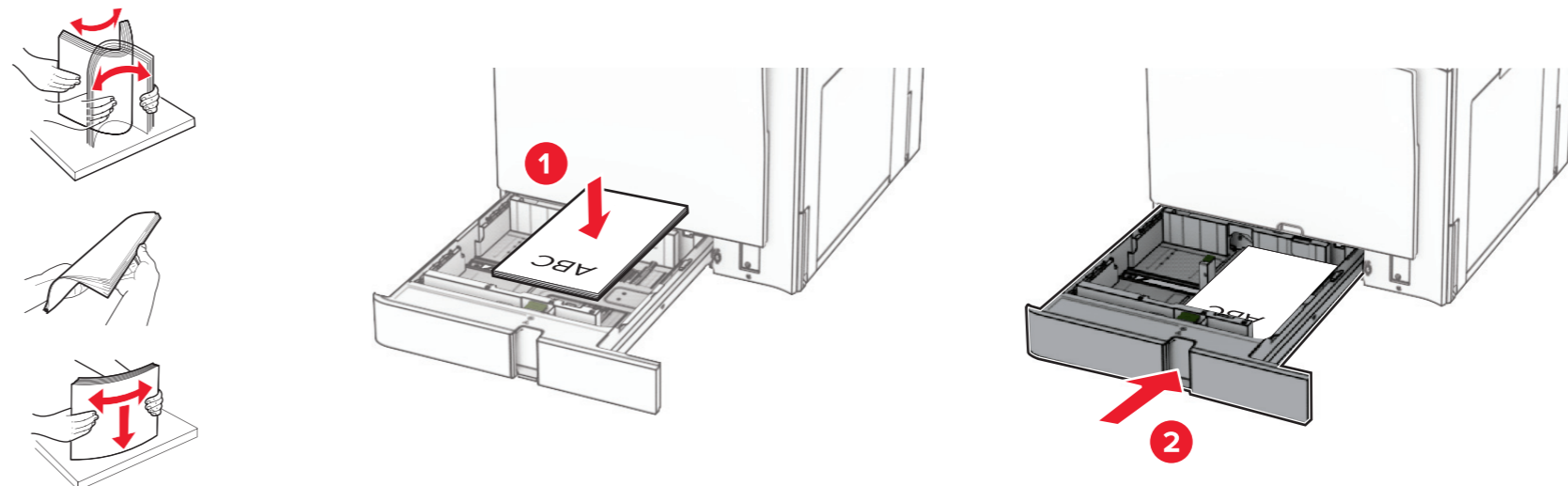

14

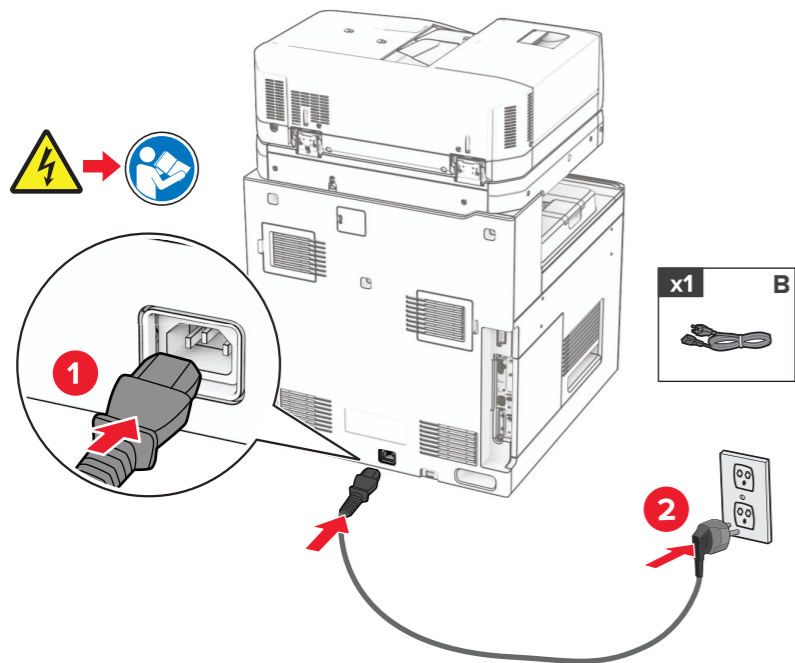

15

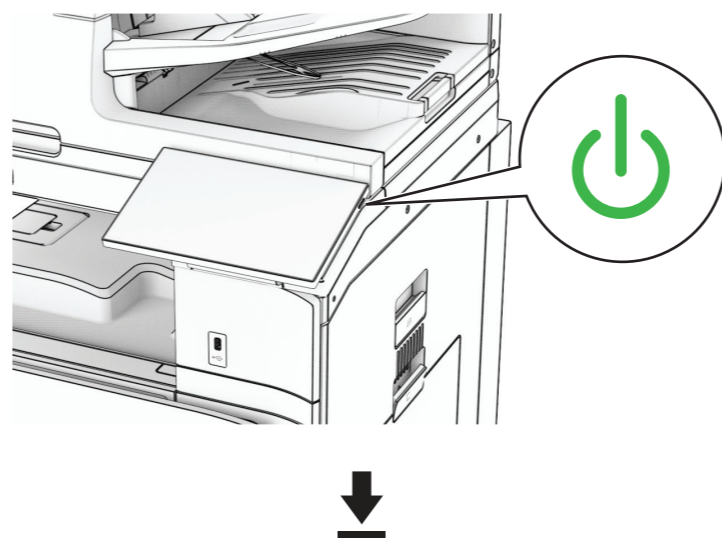

<https://support.lexmark.com/>